

EL9227-9664 | Overcurrent protection terminal, 24 V DC, 2-channel, 6 A/4 A, extended functionalities

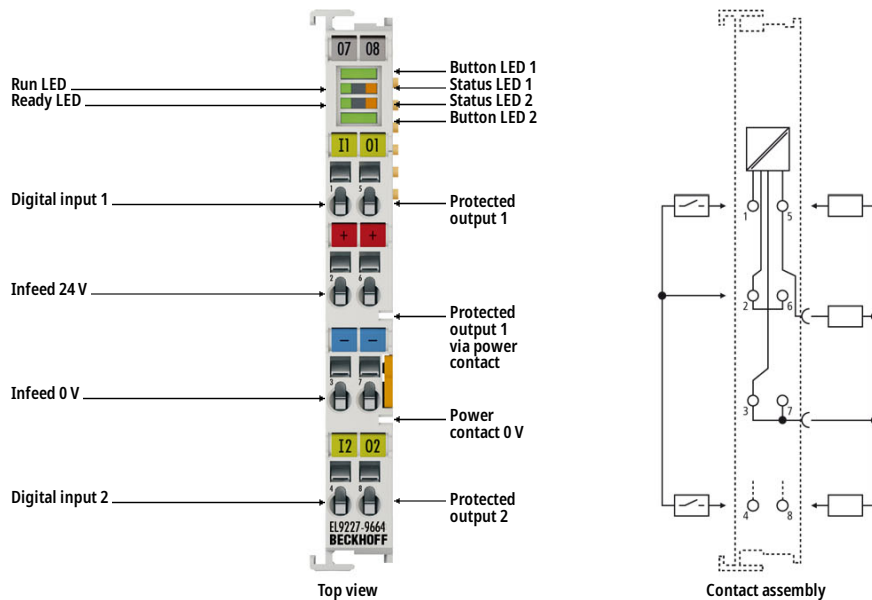
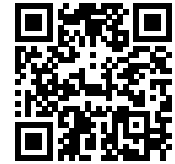

i Product status: Regular delivery

The EL9227-9482 electronic overcurrent protection terminal is a 24 V DC EtherCAT Terminal with an electronic protection function. The EL9227-9482 is a 2-channel device and switches 24 V DC overcurrents off reliably. The rated current is fixed to 8 A/2 A. The protected output 1 can be fed out via a terminal contact or directly forwarded via the power contact of neighboring terminals without wiring. The second output can be tapped via the front terminal contacts.

The EL9227-xxxx have extended functions compared to the EL9221-xxxx and EL9222-xxxx. Numerous process data are available, measured current and voltage values can also be displayed. This makes the EL9227-xxxx ideal for plant monitoring and facilitates troubleshooting, as it stores the last 10 events in a log file. In addition, there are some extended optional settings, such as e.g. characteristic curve selection, undervoltage/preliminary warning level, last state, etc. The operating status is displayed via an LED and in the process image.

Product information

Technical data

Technical data	EL9227-9664
Technology	overcurrent protection terminal 24 V DC, 2-channel
Nominal voltage	24 V DC
Number of outputs	2
Number of inputs	2
Input current	max. 10 A

Rated current	6 A/4 A
Hold after output switch-off	≥ 10 s (temperature-dependent)
Advance warning output load	adjustable; 50...100 %
Integrated fail-safe element	10 A (F) 6 A (T)
Over voltage power-off	≥ 32 V DC
Advance warning low-voltage	adjustable; 17...24 V DC
Reverse polarity switch-off	yes
Backward switch-off	adjustable; 3-stage
Current consumption E-bus	typ. 80 mA
Electrical isolation	500 V (E-bus/signal voltage)
Special features	output 1 additionally via power contact, LED button, extended functionalities
Weight	approx. 55 g
Operating/storage temperature	0...+55 °C/-25...+85 °C
Approvals/markings	CE, cULus, cURus

Housing data	EL-12-8pin
Design form	compact terminal housing with signal LEDs
Material	polycarbonate
Dimensions (W x H x D)	12 mm x 100 mm x 68 mm
Installation	on 35 mm DIN rail, conforming to EN 60715 with lock
Side by side mounting by means of	double slot and key connection
Marking	labeling of the BZxxx series
Wiring	solid conductor (e), flexible conductor (f) and ferrule (a): spring actuation by screwdriver
Connection cross-section	s*: 0.08...2.5 mm ² , st*: 0.08...2.5 mm ² , f*: 0.14...1.5 mm ²
Connection cross-section AWG	s*: AWG 28...14, st*: AWG 28...14, f*: AWG 26...16
Stripping length	8...9 mm
Current load power contacts	I _{max} : 10 A

*s: solid wire; st: stranded wire; f: with ferrule