

ELM3146-0000 | EtherCAT Terminal, 6-channel analog input, multi-function, $\pm 10 \dots \pm 1.25$ V, ± 20 mA, 24 bit, 1 ksps

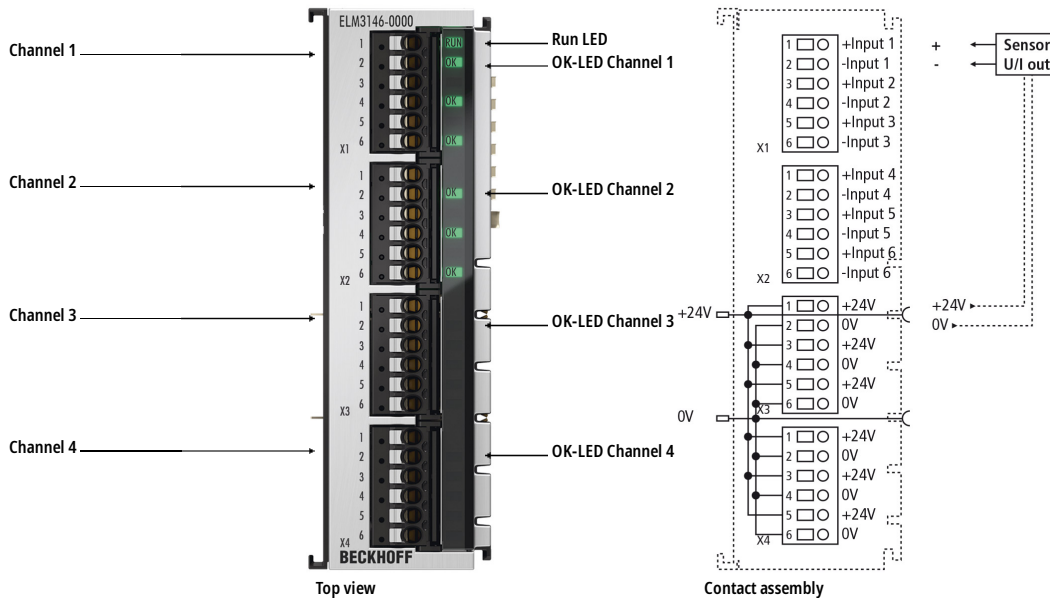
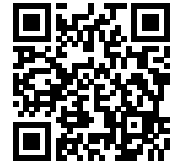

i Product status: Regular delivery

The 2-, 4-, 6- or 8-channel ELM314x EtherCAT Terminals in the Economy line can be set to current or voltage measurement channel by channel, offering sampling rates of up to 1 ksps per channel. Analog signals in the ranges from ± 1.25 to ± 10 V, 0 to 10 V, ± 20 mA or 0/4 to 20 mA can be processed. The settings for U or I measurement mode and the desired measuring ranges can be selected via the control system and TwinCAT in the CoE interface. Here it is also possible to select the extensive diagnostics features for unattended long-term use. The 2-, 4- or 6-pin push-in connectors can be removed for maintenance purposes; they enable a direct supply of connected sensors. The power contacts on the side simplify the potential distribution directly on the DIN rail. The typical EtherCAT features are available: distributed clocks functionality with timestamp and the familiar data features of the basic line such as filtering, true RMS calculation and more. Available on request as variant with factory calibration certificate or ISO 17025-/DAkkS-compliant certificate including Beckhoff recalibration service.

Extensive documentation is available from Beckhoff sales, support or measurement@beckhoff.com.

Product information

Technical data

System data	ELM314x
Voltage measurement	$\pm 10/5/2.5/1.25$ V, 0...5/10 V
Current measurement	± 20 mA, 0/4...20 mA, NAMUR NE43

Technical data ELM3146-0000

Number of channels	6
Technology	voltage or current measurement, configurable for each channel
Signal type	differential
Connection technology	2-/3-/4-wire
Connection type	push-in, service plug 6-pin
Max. sampling rate	max. 1 ms/1 ksp (per channel, multiplex)
Oversampling factor	n = 1...20 selectable
Internal resistance	> 4 M Ω (voltage), typ. 200 Ω (current)
Measuring error	typ. < ± 100 ppm/ ± 0.01 % in some measuring ranges, relative to the respective full scale value at 0...50 °C, see documentation
Functional diagnostics	yes
Connection diagnostics	broken wire/short circuit
Distributed clocks	yes, accuracy << 1 μ s
Resolution	24 bit (incl. sign)
Electrical isolation channel/channel	no
Electrical isolation channel/bus	707 V DC (type test)
Electrical isolation channel/SGND	707 V DC (type test)
Current consumption power contacts	load-dependent
Current consumption E-bus	typ. 250 mA
Weight	approx. 350 g
Operating/storage temperature	-25...+60 °C/-40...+85 °C
Thermal dissipation	typ. 2 W
Special features	ExtendedRange 107 %, free numeric filter, TrueRMS, integrator/differentiator, non-linear scaling, PeakHold, service plug, Timestamp
Approvals/markings	CE, UL

Housing data	ELM-30-xpin
Design form	metal housing with signal LEDs
Material	zinc die-cast
Dimensions (W x H x D)	30 mm x 100 mm x 95 mm
Installation	on 35 mm DIN rail, conforming to EN 60715 with lock
Side by side mounting by means of	double slot and key connection
Marking	–
Wiring	solid conductors (e): direct plug-in technique; fine-stranded conductors (f) and ferrule (a): spring actuation by screwdriver
Connection cross-section	s*: 0.2...1.5 mm ² , st*: 0.2...1.5 mm ² , f*: 0.25...0.75 mm ²

Connection cross-section AWG	s*: AWG 24...14, st*: AWG 24...14, f*: AWG 24...14
Stripping length	8...9 mm

*s: solid wire; st: stranded wire; f: with ferrule