



The New Standard of Ultra-compact PLCs

NEW

Equipped with RS485 Port

Largest in its class *1

Large Capacity Program and Data Memory

Fastest in its class *1

Ultra-high Speed Processing

Multi-axis Control available without Expansion

Industry's First *2

Battery-less Automatic Backup of All Data



*1. Among compact PLCs with up to 128 I/O points based on our research as of July 1, 2011

*2. Based on our research as of July 1, 2011



Our Mission is to Maximize Customer Benefits with Enhancing Advanced Functionality and Performance.

The Answer is **FPO_R**, Superior to Basic Ultra-

Smallest in its class *1

The control unit is small at 90 mm 3.54 in in height and 25 mm 0.98 in in width. Even when expanded with three expansion units, the total width only 100 mm

The ultra-compact space-saving body size facilitates the miniaturization of target machines, equipment, and control panels.

Ultra compact
I/O points **Min. 10 points**
Max. 128 points

The number of I/O points is expandable up to 128 by adding three expansion units having 32 I/O points each to one control unit equipped with 32 I/O points.

Input/Output terminals

Only one cable is required for communications with the "Control FPCWIN Pro" or "Control FPCWIN GR" programming tool.

Tool ports

Equipped with both USB 2.0 and RS232C ports.

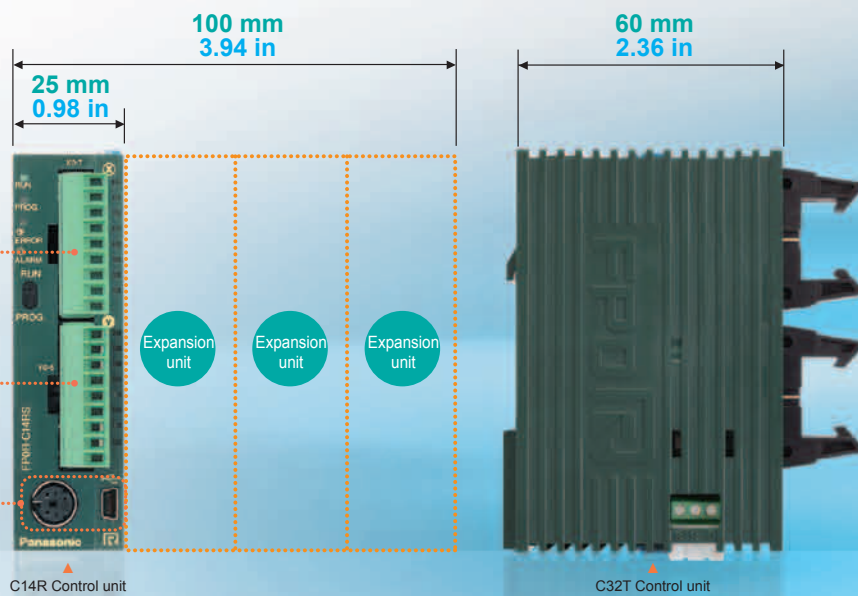

Multi-axis (4-axis) control is available without expansion units.

The built-in 4-axis pulse outputs allow multi-axis motor control without positioning units or other expansion units.

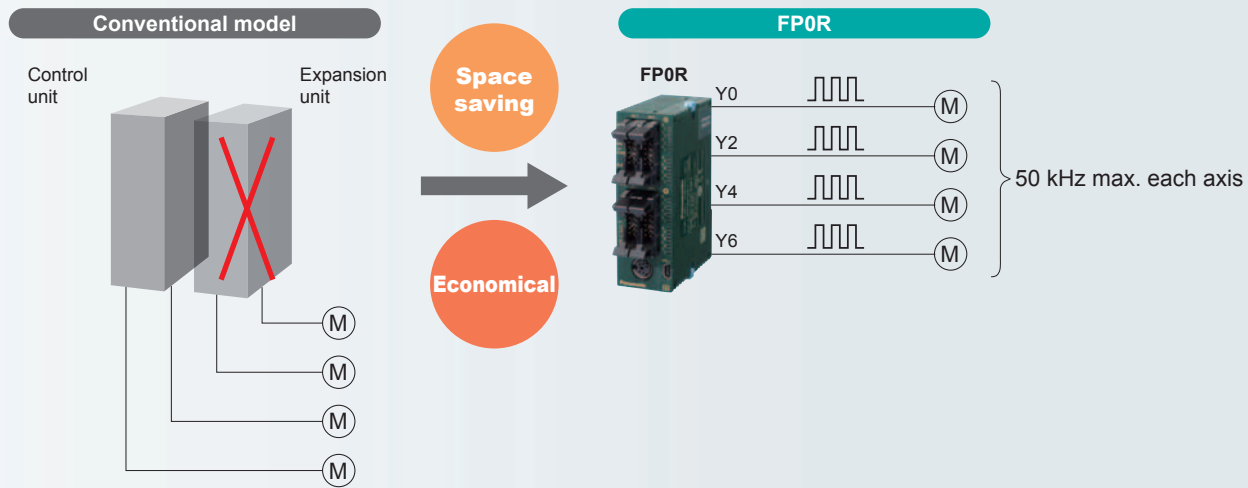

Outstanding Products



Worldwide simultaneous launch of the 3-year warranty
 For details, visit the following website:
panasonic-denko.co.jp/ac/e/fasys/warranty

compact Models.

3.94 in.



Industry's First *

Battery-less automatic backup of all data

- The F type (FP0R-F32) has a built-in FeRAM, which is a cutting-edge device that allows the automatic saving of all data without a backup battery.
- There is no need to worry about data loss after a long vacation.
 - Battery replacement is no longer necessary when shipping or transferring the unit overseas.
 - Replacement of equipment and restoration of idle equipment is easy.
 - The unit can be powered off flexibly on weekends or at other non-operating times, promoting energy saving.

* Based on our research as of July 1, 2011

NEW

Equipped with RS485 port

Up to 99 units can be connected, expanding applications for the eco-conscious business field.
 The PLC link is available with up to 16 other FP series and FP0R units.

Fastest in its class *1

Ultra-high speed processing

Ultra-high speed: 80 ns/step (ST instructions)
 * Within a range of 0 to 3,000 steps. Processing of the 3,001st and later steps is 580 ns, 1.5 times faster than the conventional model.
 Note: Unit expansion increases the base time.

Base scan time: I/O refresh + base time
--

Without expansion units: 0.2 ms or less
 With expansion units: 0.2 ms or less + (1 x Number of expansion units) ms

Large capacity independent comment memory

Program maintenance and management become easier.

USB tool port provided as standard equipment

Programming work becomes simpler, easier, and quicker, improving the production efficiency.

Full-fledged positioning functions

A variety of dedicated instructions enable high-accuracy positioning.

Largest in its class *1

Large capacity program

Program capacity: 32 k steps *2
 Data register: 32 k words *2

*1 Among compact PLCs with up to 128 I/O points based on our research as of July 1, 2011
 *2 C10, C14 or C16 control unit: Program capacity of 16 k steps and data register of 12 k words

POSITIONING

Jog positioning control (F171 instruction)

The motion can be started without a preset target value. When a stop signal is input, the target value is set, and the motion is slowed to a stop.

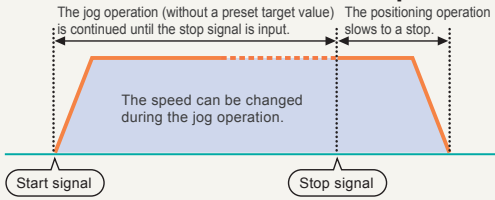

Useful for

- Labelers: Stopping the motion at a constant distance from the point where a label end detection signal is triggered
- Processing machines: Stopping the motion at a constant distance from the point where a processing object edge detection signal is triggered, and cut/drill the object

Changing the speed (available for F171 and F172 instructions)

The target speed can be changed by an external signal input during the jog operation or trapezoidal control operation.

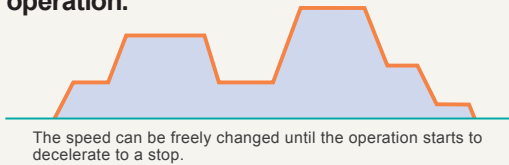

Useful for

- Speed synchronization of transfer or processing equipment.

Built-in 4-axis pulse outputs (Transistor output type)

Two sets can simultaneously undergo two-axis linear interpolation.

No complicated speed calculation or programming is required. Two-axis linear interpolation is available by using the F175 dedicated instruction. Two sets such as two X-Y tables, for example, can be simultaneously controlled.

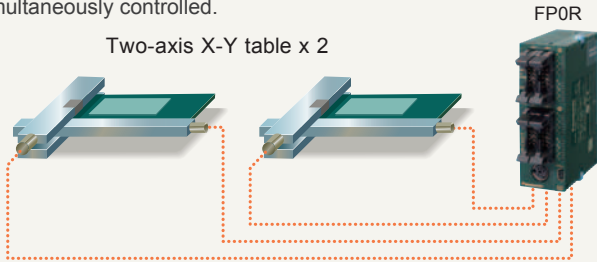

Built-in multipoint PWM outputs (4 channels)

The pulse output port of FP0R can also serve as a PWM output port. One of the application examples is an analog voltage output, which can be used for inverter speed control.

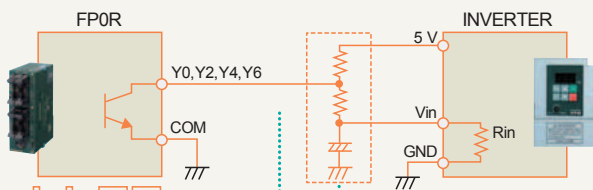

The speed can be controlled by changing the ON width of the PWM output.

The unit can also serve as an analog voltage output when a smoothing capacitor is inserted in the circuit.

Individual settings for acceleration and deceleration (available for F171, F172, and F174 instructions)

The acceleration time and deceleration time can be individually set.

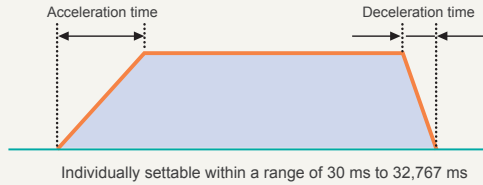

Useful for

- Labelers: Starting the operation at a relatively low acceleration to prevent tape from breaking. Stopping the operation at high deceleration when detecting the label end to save the tape
- Lifts: Optimizing the acceleration and deceleration during ascending and descending transfers.

Measuring the pulse frequency (F178 instruction)

Pulses input in a specified period by a single instruction are counted, and the frequency is calculated.

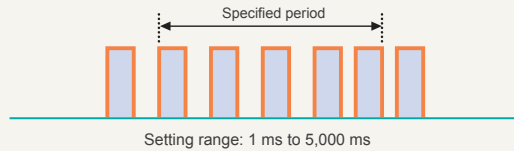

Useful for

- Detection of motor rotation speed for encoder feedback control

High-speed counters and pulse outputs

Ladder programs can be combined to create an application for counting pulse signals from the encoder through the high-speed counter input and adjusting the pulse output frequency based on the count to synchronize the slave axis speed with the master axis speed.

In the right-hand figure, the speed of conveyor 1, which is inverter-controlled, is measured based on the encoder pulse count, and pulses are output to the slave motor (for jog operation) according to the measured speed in order to synchronize the speed of conveyor 2.

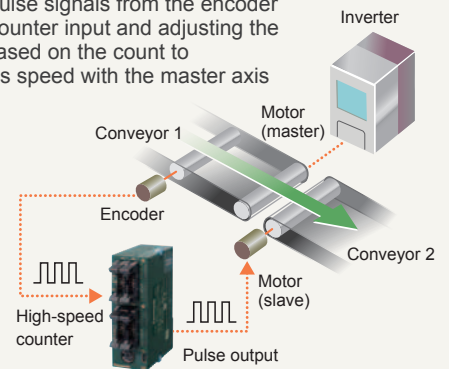

■ PLC link (MEWNET-W0)

Contact data can be shared among up to 16 PLC units, including FP0R, FPΣ, FP-X, FP2/FP2SH, and a mixture of them, without the need for programs.

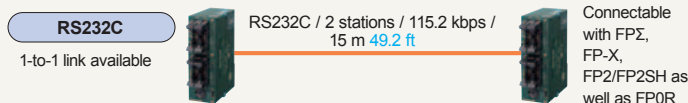

Application examples

Use two FP0R units to control the assembly and transfer sections of a small machine respectively, connect them via the PLC link, and share one display

RS485

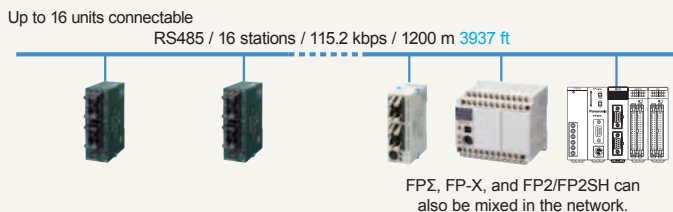

Application examples Management of manufacturing line operations

■ RS485 serial communication

Compatible with both Modbus master and slave RTU.

This feature expands applications for the eco-conscious business field, and is ideal for the control of air conditioners, temperature, and electrical power.

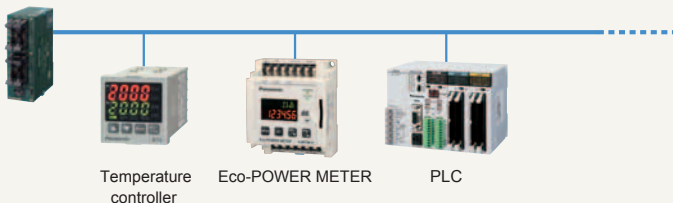

• Up to 99 units can be connected.

When 17 or more FP series units need to be linked, you can link up to 99 units by using the Modbus function instead of MEWNET-W0. Since each FP0R unit can be either a master or a slave, a multi-master link can be created by passing a token from a user program.

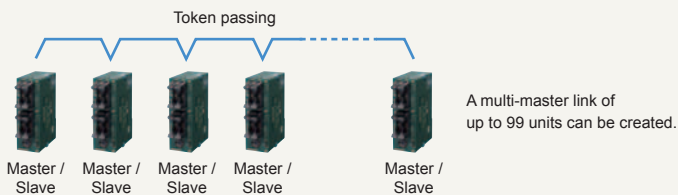

■ CC-Link slave unit

This unit is compatible with CC-Link, which is an open network, and capable of reading/writing four-word data through a maximum of 16 input and 16 output points.

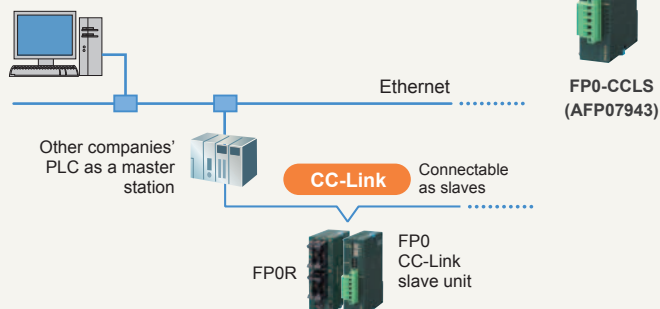

■ FP Web-Server2

The FP0R operation status can be monitored on a Web browser.

The FP0R operation status can be monitored on a Web browser by connecting FP Web-Server2 and FP0R via RS232C and making required settings using dedicated software (FP Web Configurator Tool 2).



FP Web-Server2 (AFP0611)

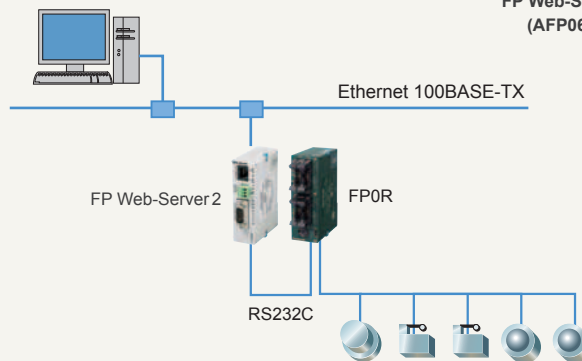

■ RS232C general-purpose serial communications

The control unit has an RS232C port for serial communications.

The RS232C port allows for direct connection to an operation display panel or a PC. Also, it facilitates bi-directional data communications with bar-code readers and other RS232C devices.

- * The port block has S, R, and G terminals for connection. Operation display panels can also be connected to the tool port.
- * Both the relay output and transistor output types of control unit equipped with an RS232C port are available.

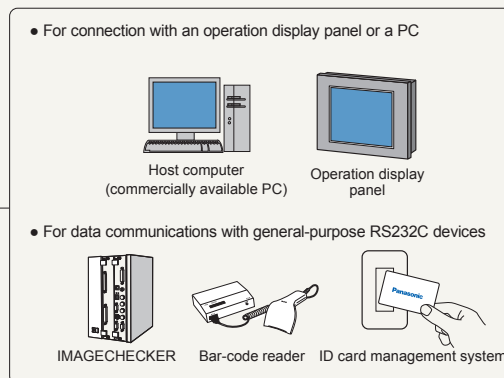

■ I/O link unit

This link unit enables FP0R to serve as a slave station of MEWNET-F (remote I/O system) and exchange I/O data from 32 input points and 32 output points with a master station without the need for programs.

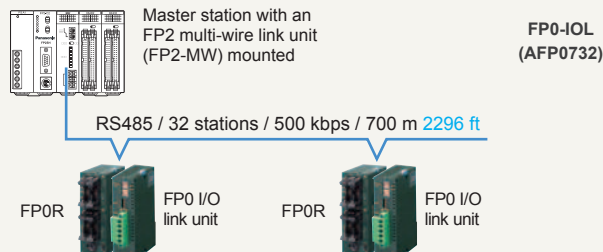

OTHER USEFUL FUNCTIONS

Program protection

Program upload protection setting

User programs can be protected from unauthorized copying by disabling program upload using our software, FPWIN. This function is useful for users who manage original programs on a PC.

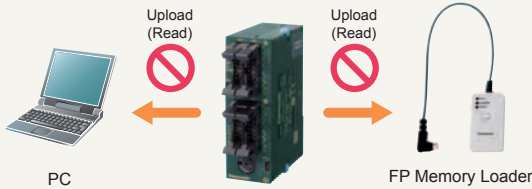

Eight-character password

Since uppercase and lowercase alphanumeric characters can be used, there are approx. 218 trillion possible password combinations. If an incorrect password is entered three times in a row, a cold reboot is required. This function is useful for users who upload programs from FP0R.

Temperature controller

- A temperature control program can be written in only one line by using a PID instruction (F356 EZPID), facilitating temperature control programming by a PLC, which had previously been considered difficult.
- The total accuracy is $\pm 0.8^{\circ}\text{C}$ $\pm 33.44^{\circ}\text{F}$ (K, J and T range). Two types are available: 4-channel and 8-channel types. Up to three units can be connected, allowing high-accuracy multi-point PID control of a maximum of 24 channels.

Thermocouple unit



4ch AFP0420 (FP0-TC4) 8ch AFP0421 (FP0-TC8)

Built-in real-time clock (T type only)

The clock allows for year, month, day, hour, minute, and second data processing. The clock data can be linked to periodic monitoring of production data and operation status, and the management of error history records.

Interrupt input

This function takes in input signals at high speed regardless of the scan time and instantly executes the interrupt program. This is useful for high-accuracy positioning control or control of defective item ejector valves. The X0 to X7 inputs can be designated as interrupt inputs (C10: X0 to X5).

Pulse catch

This function can take in 10 μs short pulse inputs and is therefore ideal for taking in signals from a sensor to detect small components.

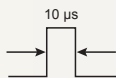

The X0 to X7 inputs can be designated as pulse catch inputs.

Analog I/O

The lineup includes a compact analog I/O unit with one analog output and two analog input channels, an A/D converter unit with eight analog input channels, and a D/A converter unit with four analog output channels. Communication using up to 24 channels is possible. Both the compact body size and the high input/output resolution of 1/4,000 (12 bits) have been achieved. The DIP switches in the unit cover a variety of input/output ranges and are user-friendly.



Analog I/O unit	A/D converter unit	D/A converter unit	D/A converter unit
Input: 2ch / Output: 1ch	Input: 8ch	Voltage output: 4ch	Current output: 4ch
AFP0480 (FP0-A21)	AFP0401 (FP0-A80)	AFP04121 (FP0-A04V)	AFP04123 (FP0-A04I)

EEPROM data saving (F12 and P13 instructions)

All FP0R series models are equipped with EEPROM, which can electrically rewrite data and retain data without the need for voltage supply. Setting data and production result data can be written and saved by the P13 instruction, and read out by the F12 instruction when necessary.



Note: Each block is limited to 10,000 write operations.

Program download in RUN mode (Comment writable)

Even while the equipment is operating with FP0R in RUN mode, a whole program edited offline can be downloaded to FP0R, and comments can be written simultaneously. Programs can be changed without stopping a running production line.

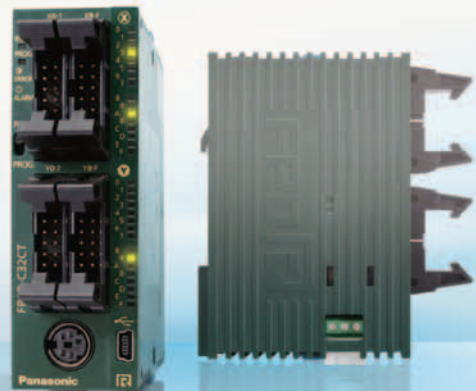
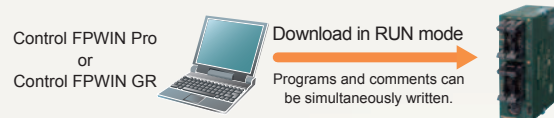

PROGRAMMING SOFTWARE

Control FPCWIN Pro (IEC61131-3 compliant Windows version software)

Compliant with international standard IEC61131-3
Programming software approved by PLC Open

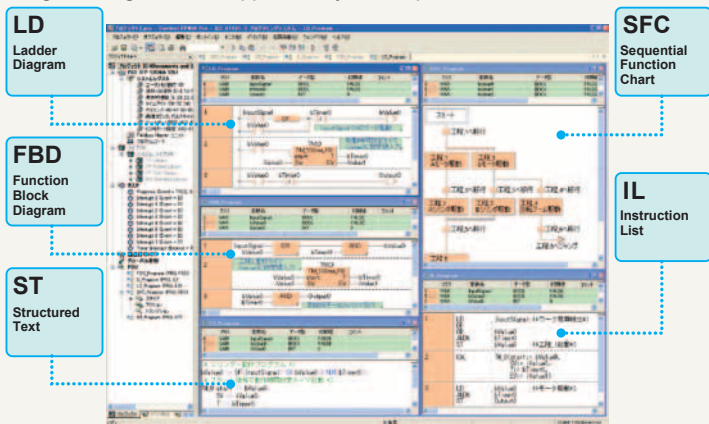
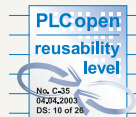

Features

- Five programming languages can be used.**
Programming can be done using the language most familiar to the developer or using the language most suited to the process to be performed. High-level (structured text) languages that allow structuring, such as C, are supported.
- Easy to reuse well-proven programs**
Efficiency when writing programs has been greatly increased by being able to split programming up for each function and process using structured programming.
- Keep know-how from getting out**
By "black boxing" a part of a program, you can prevent know-how from leaking out and improve the program's maintainability.
- Uploading of source programs from PLC possible.**
Maintainability increased by being able to load programs and comments from the PLC.
- Programming for all models in the FP series possible.**

Programming in the language most suited to the process

Easy-to-understand, efficient programs can be created, for example, by using a ladder program for machine control or ST for communications control.

Programming in the language you are good at

Programming time can be greatly reduced by the easy ability to split and then integrate programming for each function and process.

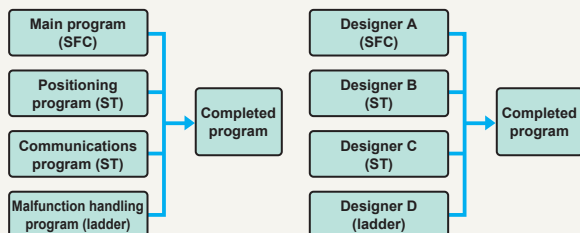

Operational Environment * FPO R is compatible with Ver. 6.1 or later.

OS	Windows 2000/XP/Vista/7 (Note)
Hard disk capacity	At least 120 MB
CPU	Pentium III processor (700 MHz) or compatible
Onboard memory	At least 256 MB RAM or more
Screen resolution	At least 1,024 x 768
Display colors	High Color (16-bit) or higher
Applicable PLC	FP0R/FP0/FPΣ/FP-X/FP-e/FP2/FP2SH

Note: Only Ver. 6.2 or later is compatible with Windows 7. (To be released in September 2011)

Control FPCWIN GR (Windows version software)

The ladder programming software for FP series Highly operational software tool for maximizing convenience in the field

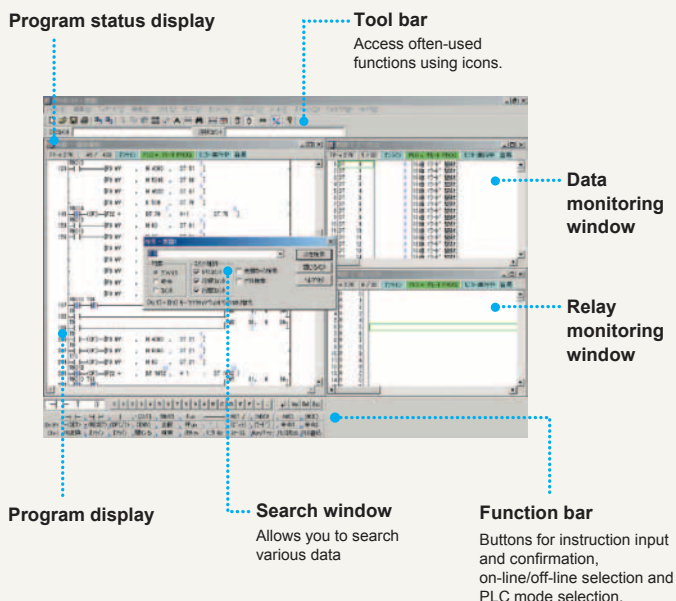

Features

- Easy field operations not requiring the use of a mouse for data entry, search, writing, monitoring and timer changes, all carried out only from the keyboard.**
- All FP series PLCs are supported.**
- Easy programming with wizard functions.**
- Communication with GTWIN and PCWAY simultaneously through the same port.**
- A simulation function is available.**









Operational Environment * FPO R is compatible with Ver. 2.8 or later.

OS	Windows 98/Me/2000/XP/Vista/7 (Note)
Hard disk capacity	At least 40 MB
CPU	Pentium 100 MHz or higher
Onboard memory	At least 64 MB (depends on OS)
Screen resolution	At least 1,024 x 768
Display colors	High Color (16-bit) or higher
Applicable PLC	FP0R/FP0/FPΣ/FP-X/FP-e/FP2/FP2SH











Note: Only Ver. 2.90 or later is compatible with Windows 7.

PART NUMBER LIST

Control units





10 points Input: 6, Relay output: 4 Terminal block type  AFP0RC10RS (with RS232C) AFP0RC10CRS (with RS485) AFP0RC10MRS	10 points Input: 6, Relay output: 4 Connector type  AFP0RC10RM (with RS232C) AFP0RC10CRM	14 points Input: 8, Relay output: 6 Terminal block type  AFP0RC14RS (with RS232C) AFP0RC14CRS (with RS485) AFP0RC14MRS	14 points Input: 8, Relay output: 6 Connector type  AFP0RC14RM (with RS232C) AFP0RC14CRM
16 points Input: 8, Transistor output: 8 MIL connector type  AFP0RC16T AFP0RC16P (with RS232C) AFP0RC16CT AFP0RC16CP (with RS485) AFP0RC16MT AFP0RC16MP	32 points Input: 16, Transistor output: 16 MIL connector type  AFP0RC32T AFP0RC32P (with RS232C) AFP0RC32CT AFP0RC32CP (with RS485) AFP0RC32MT AFP0RC32MP	32 points Input: 16, Transistor output: 16 MIL connector type T type  (with RS232C) AFP0RT32CT AFP0RT32CP (with RS485) AFP0RT32MT AFP0RT32MP	32 points Input: 16, Transistor output: 16 MIL connector type F type  (with RS232C) AFP0RF32CT AFP0RF32CP (with RS485) AFP0RF32MT AFP0RF32MP

Expansion units

8 points Input: 8 MIL connector type  AFP0RE8X	8 points Input: 4, Relay output: 4 Terminal block type Connector type   AFP0RE8RS AFP0RE8RM	8 points Relay output: 8 Terminal block type  AFP0RE8YRS	8 points Transistor output: 8 MIL connector type  AFP0RE8YT AFP0RE8YP	32 points Input: 16, Transistor output: 16 MIL connector type  AFP0RE32T AFP0RE32P
16 points Input: 16 MIL connector type  AFP0RE16X	16 points Transistor output: 16 MIL connector type  AFP0RE16YT AFP0RE16YP	16 points Input: 8, Transistor output: 8 MIL connector type  AFP0RE16T AFP0RE16P	16 points Input: 8, Relay output: 8 Terminal block type Connector type   AFP0RE16RS AFP0RE16RM	



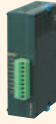

Intelligent units

Units in common with FP0

Analog I/O unit Input: 2 ch, Output: 1 ch Terminal block type  Part number: AFP0480 Product number: (FP0-A21)	A/D converter unit Input: 8 ch Terminal block type  AFP0401 (FP0-A80)	D/A converter unit Voltage output: 4 ch Terminal block type  AFP04121 (FP0-A04V)	D/A converter unit Current output: 4 ch Terminal block type  AFP04123 (FP0-A04I)	Thermocouple unit  (4 ch) AFP0420 (FP0-TC4) (8 ch) AFP0421 (FP0-TC8)
---	---	--	--	---



Link and Communication units

Units in common with FP0

I/O link unit  Part number: AFP0732 Product number: (FP0-IOL)	CC-Link slave unit  AFP07943 (FP0-CCLS)	KS1 Signal converter  AKS1202	FP Web-server 2 Unit  AFP0611 (FP-WEB2)
--	--	---	--

Power supply unit and others

Units in common with FP0

Power supply unit Input: 100 to 240 V AC, Output: 24 V DC, 0.7 A  Part number: AFP0634 Product number: (FP0-PSA4)	FP memory loader  Data clear type: AFP8670 Data hold type: AFP8671 * FP0R is compatible with Ver. 2.0 or later.
--	---

INSTALLATION AND OPTIONS

Installation

The control unit width is only 25 mm 0.98 in*. Even when expanded to allow for 128 I/O points, the total width is only 105 mm 4.13 in.

The control unit is pocket-sized: W 25 x H 90 x D 60 mm W 0.98 x H 3.54 x D 2.36 in.

The number of I/O points can be expanded up to 128. Even with the maximum expansion, the size is only W 105 x H 90 x D 60 mm W 4.13 x H 3.54 x D 2.36 in. The ultra-compact body size and installation area facilitate the miniaturization of target machines, equipment, and control panels.

* The 32 I/O points type control unit is 30 mm 1.18 in in width.

Three options for installation methods

The control unit can be directly mounted on a panel by using the optional flat type mounting plate.



DIN rail

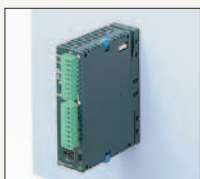

Slim type mounting plate

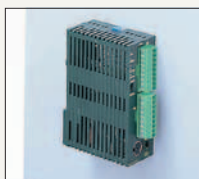

Flat type mounting plate*

* Cannot be used when expanded.

Up to three expansion units can be directly connected without connection cables.

The expansion units can be directly connected to the control unit with a simple operation using the expansion connector and lock lever on the side of the unit. Dedicated cables or backplanes are not necessary for expansion.

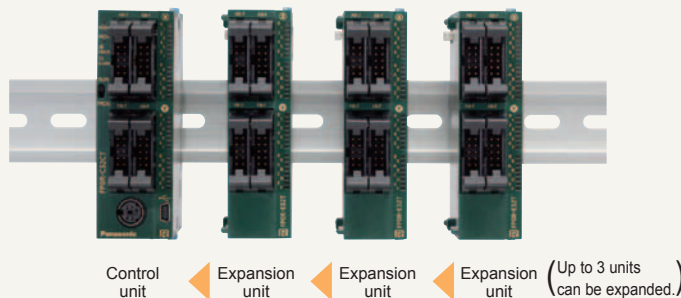

A terminal block type and a connector type are available. Both can be detached for easy wiring.

Options

Wiring tools



Terminal screwdriver

Necessary when wiring relay output type and terminals block (Phoenix).

Part number: **AFP0806**



Molex connector pressure contact tool

Necessary when wiring relay output type and molex connectors.

Part number: **AFP0805**



Multi-wire connector pressure contact tool

Necessary when wiring transistor output type connectors.

Part number: **AXY52000FP**

Parts for mounting



FP0 Slim type mounting plate

Screw-stop attachment plate, Slim model

Part number: **AFP0803** (including 10 pieces)



Flat type mounting plate

Screw-stop attachment plate, Flat model

Part number: **AFP0804** (including 10 pieces)

I/O cables



Relay output molex type I/O cable

Loose-wiring cable (9 leads) with molex socket attached at one end, AWG20, 0.5 mm², 1 set: 2 cables (blue & white)

< Length: 1 m 3.28 ft > 2 cable set < Length: 3 m 9.84 ft > 2 cable set

Part number: **AFP0551** Part number: **AFP0553**



Transistor output type I/O cable

Loose-wiring cable (10 leads) with connectors attached at one end, AWG22, 0.3 mm², 1 set: 2 cables (blue & white).

< Length: 1 m 3.28 ft > 2 cable set < Length: 3 m 9.84 ft > 2 cable set

Part number: **AFP0521** Part number: **AFP0523**

Flat cable connector set (10 leads)

Part number: **AFP0808** (including 4 pieces)

Notes: 1) One I/O cable set (2 cables) is necessary with the following models: C10RS / C10RM, C14RS / C14RM, E8RS / E8RM, E16RS / E16RM

2) One I/O cable set (2 cables) is necessary with the following models: C16T / E16X, E16T / E16YT

3) Two I/O cable sets (total 4 cables) are necessary with the following models: C32T / E32T

Maintenance parts

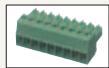

Terminal socket

Attaches to relay output and terminal block types.

Part number: **AFP0802** (2 sockets per pack)



Molex socket

Attaches to relay output and molex connector types.

Part number: **AFP0801** (2 sockets per pack)



Wire-press socket

Attaches to transistor output type.

Part number: **AFP0807** (2 sockets per pack)



FP0R Power cable (Length: 1 m 3.28 ft)

Attaches to FP0R control unit.

Part number: **AFP0805** (1 cable per pack)

OPTIONS

■ OPTIONS

● RT-3 unit relays (Power PhotoMOS relay type)



RT-3 unit relay

Contact arrangement	Type	Rated input voltage	RT-3 Unit relay		
			Product No.	Part No.	Packing quantity
1 Form A × 4	DC only (equipped with AQZ102)	12 V DC	RT3SP1-12V	AY34001	Inner carton: 1 piece Outer case: 20 pieces
		24 V DC	RT3SP1-24V	AY34002	
	AC / DC dual use (equipped with AQZ204)	12 V DC	RT3SP2-12V	AY35001	
		24 V DC	RT3SP2-24V	AY35002	

Notes: 1) Only for use with Power PhotoMOS relays. Cannot be equipped with PA relays.
2) Please consult us other contact arrangement.

● RT-3 unit relays (PA relay type)



RT-3 unit relay

Contact arrangement	Rated input voltage	RT-3 Unit relay		
		Product No.	Part No.	Packing quantity
1 Form A × 4	12 V DC	RT3S-12V	AY33001	Inner carton: 1 piece Outer case: 20 pieces
	24 V DC	RT3S-24V	AY33002	

Notes: 1) Only for use with PA relay type. Cannot be equipped with Power PhotoMOS relay standard type. However, equipping with voltage sensitive type is possible.
2) 5 V DC type relays are also available. Please consult us.
3) Please consult us other contact arrangement.

● 4-point terminals

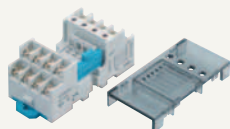

4-point terminals

Type	Rated input voltage	Part No.
PA relay and Voltage sensitive type power PhotoMOS relay type	12, 24 V DC	AY30000

Packing quantity: inner carton: 1 piece, outer case: 20 pieces

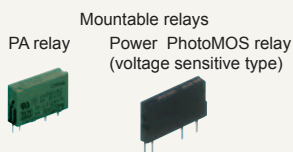

Mountable relays for 4-point terminal

Product name	Part No.
PA relay	APA3311 and APA3312
Power PhotoMOS relay (voltage sensitive type)	AQZ10*D (DC only)
	AQZ20*D (AC / DC dual use)

Note: Never mount relays into this product other than those given above.
Doing so will cause malfunction, breakdown, and breakdown of the connected product.

● RT-2 relay terminals

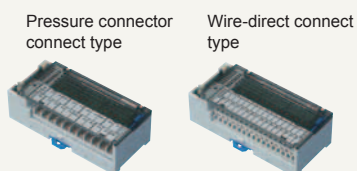

DIN rail mounting type

1. Pressure connector connect type

I / O type	Rated voltage	Product No.	Part No.	Packing quantity
Input device	12 V DC	RT2S-ID16-12V	AY231501	Inner carton: 1 piece Outer case: 10 pieces
	24 V DC	RT2S-ID16-24V	AY231502	
Output device	12 V DC	RT2S-OD16-12V	AY232501	
	24 V DC	RT2S-OD16-24V	AY232502	

2. Wire-direct connect type

I / O type	Rated voltage	Product No.	Part No.	Packing quantity
Input device	12 V DC	RT2S-C-ID16-12V	AY231511	Inner carton: 1 piece Outer case: 10 pieces
	24 V DC	RT2S-C-ID16-24V	AY231512	
Output device	12 V DC	RT2S-C-OD16-12V	AY232511	
	24 V DC	RT2S-C-OD16-24V	AY232512	

■ OPTIONS

● Cables

Expansion cable with wire-pressed terminal



Expansion cable



M type 16-point, 34-pin output cable



Connecting cables for FP series and Interface terminal

Product name	Controller side unit	No. of connector contacts of controller side	Interface terminal	Product name and shape	Connecting cable						
					250 mm 9.84 in	500 mm 19.69 in	1,000 mm 39.37 in	1,500 mm 59.06 in	2,000 mm 78.74 in	3,000 mm 118.11 in	5,000 mm 196.85 in
FP0 FP0R FPΣ	8 points Input unit	Input side: 10-pin	RT-2 relay terminal RT-1 PC relay terminal	For FP0 and FP0R 8-point input 	-	-	AY15013	AY15014	AY15015	AY15016	AY15017
	16 points Input unit	Input side: 10-pin × 2	RT-2 relay terminal RT-1 PC relay terminal	For FP0, FP0R and FPΣ 16-point input 	-	-	AY15913	AY15914	AY15915	AY15916	AY15917
	8 points Output unit	Output side: 10-pin	RT-2 relay terminal RT-1 PC relay terminal	For FP0 and FP0R 8-point output 	-	-	AY15023	AY15024	AY15025	AY15026	AY15027
	16 points Output unit	Output side: 10-pin × 2	RT-2 relay terminal RT-1 PC relay terminal	For FP0, FP0R and FPΣ 16-point output 	-	-	AY15923	AY15924	AY15925	AY15926	AY15927
	16 points I/O unit	I/O side: 20-pin	Connector terminal	 20P	-	AYT52202	AYT52203	AYT52204	AYT52205	AYT52206	AYT52207
	64 points I/O unit	I/O side: 40-pin	RT-2 relay terminal RT-1 PC relay terminal / S type	For FPΣ 64-point I/O unit Controller side: 32 points, 16 points Terminal side: 20 points, 16 points	-	-	AY15633	AY15634	AY15635	AY15636	AY15637

(Standard packing; carton: 1 pc., Case: 10 pcs.)

Expansion cables with wire-pressed terminal for relay terminal

Product name and shape	I/O type	Relay terminal	Length (Part number)				
			1,000 mm 39.37 in	1,500 mm 59.06 in	2,000 mm 78.74 in	3,000 mm 118.11 in	5,000 mm 196.85 in
Expansion cable with wire-pressed terminal Relay terminal side	16-point both input and output	RT-2 relay terminal RT-1 PC relay terminal / S type	AY15853	AY15854	AY15855	AY15856	AY15857

Note: Please consult us regarding connecting cables for the various controllers. Regarding the expansion cables with wire-pressed terminal, the triangle mark does not correspond to wire No. 1, so be sure to inquire for details.

● WAGO DIO Station

For Easy and Secure Connection Between FP0R and a Sensor

Power supply unit → 24 V DC → **FP0R**

(1) Common terminal block

24 V DC can be branched.

Power is supplied through the cable to the PLC common terminal and the sensor.

The cable comes in lengths up to 10 m 32.81 ft in increments of 0.1 m 0.33 ft.

(2) Cable for input

(3) Cable for output

Quick connection with DIO using the finger lever. The connector can be reused.

Even a thin sensor or electrical wire can be connected. (0.08 - 0.5 sq)

Example: Sensor

Example: Switch and Lamp

(2)(3) Cable specifications
AWG28, Rated voltage: 30 V
Outer diameter of sheath: \varnothing 4.4 \varnothing 0.17
Minimum allowable bending radius: R = 13.2
Power supply wire: 0.3 sq, 250 mm 9.84 in

Product name	Product number	Ident number
(1) Common terminal block	PM-PW8-739/3.5	51197832
(2) PM flexible cable for input	PM-FP0X-M733SS-F1M	51251907
(3) PM flexible cable for output	PM-FP0Y-M733SS-F1M	51251909
(4) 8 points, MIL-DIO station	PM-M733-3X8PC-S1	51238076

Contact WAGO Kontakttechnik GmbH & Co. KG for inquiries about DIO Station.
URL: <http://www.wago.com>

COMPATIBILITY

Compatibility between FP0 and FP0R

Programs

FP0R has an "FP0-compatible mode". This mode provides conditions for functions, memory areas, system registers, etc. identical to those of FP0. If programs in FP0 are transported to FP0R, FP0R can function identically as FP0 did (with some exceptions described below).

Installation

The shape, outside dimensions, installation method, and the connector pin arrangement are identical to those of FP0.

This high degree of compatibility ensures easy and worry-free replacement of FP0 with FP0R even if the device or machine to be manufactured is identical.

- It is recommended that Control **FPWIN Pro** or **FPWIN GR** should be used for transporting FP0 programs to FP0R. Before an FP0 program is downloaded to FP0R, a message stating "Switch to FP0-compatible mode for the download?" appears. If "Yes" is chosen, FP0R will automatically be set in FP0-compatible mode.

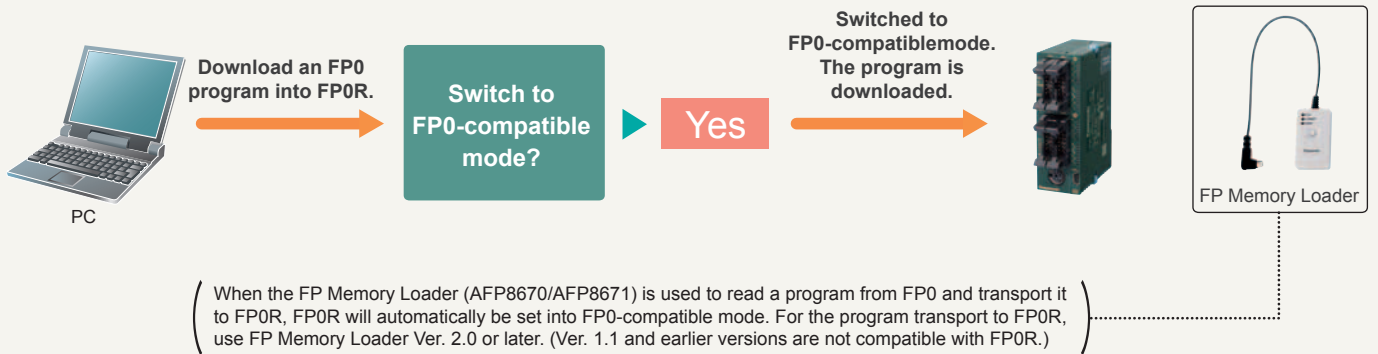

- FP0 specification items not covered by FP0-compatible mode** (See "FP0R User's Manual" for details.)

Item	FP0	FP0R (FP0-compatible mode)
Instruction P13: EEPROM write time	5 ms / block (256 blocks max.: 1,280 ms)	100 ms in units of 32 blocks (256 blocks max.: 800 ms) * Writing even only one block takes 100 ms.
Instruction F170: PWM output frequency range	0.15 Hz to 1 kHz	6 Hz to 1 kHz
High-speed counter/pulse output elapsed value	± 24 bits	± 32 bits
Instruction F168: Home return	The elapsed value is not counted during home return.	The elapsed value is counted during home return.
Instruction F169: Pulse output	"Non-counting mode" selectable	Counted and added even when "non-counting mode" is selected
Instruction F144: Serial data communications	Transmittable data size: Unlimited	Transmittable data size: 2,048

Note: The F type has no compatible functions because it does not correspond to any units of the conventional FP0 series.

■ Control unit replacement table

FP0
➔ FP0R

Product name	Product No.	Part No.		Product name	Part No.
FP0-C10 Control unit	FP0-C10RS	AFP02123	Order receiving will be discontinued in August 2012.	FP0R-C10 Control unit	AFP0RC10RS
	FP0-C10RM	AFP02113			AFP0RC10RM
FP0-C10 Control unit with RS232C port	FP0-C10CRS	AFP02123C		FP0R-C10 Control unit with RS232C port	AFP0RC10CRS
	FP0-C10CRM	AFP02113C			AFP0RC10CRM
FP0-C14 Control unit	FP0-C14RS	AFP02223		FP0R-C14 Control unit	AFP0RC14RS
	FP0-C14RM	AFP02213			AFP0RC14RM
FP0-C14 Control unit with RS232C port	FP0-C14CRS	AFP02223C		FP0R-C14 Control unit with RS232C port	AFP0RC14CRS
	FP0-C14CRM	AFP02213C			AFP0RC14CRM
FP0-C16 Control unit	FP0-C16T	AFP02343		FP0R-C16 Control unit	AFP0RC16T
	FP0-C16P	AFP02353			AFP0RC16P
FP0-C16 Control unit with RS232C port	FP0-C16CT	AFP02343C		FP0R-C16 Control unit with RS232C port	AFP0RC16CT
	FP0-C16CP	AFP02353C			AFP0RC16CP
FP0-C32 Control unit	FP0-C32T	AFP02543		FP0R-C32 Control unit	AFP0RC32T
	FP0-C32P	AFP02553			AFP0RC32P
FP0-C32 Control unit with RS232C port	FP0-C32CT	AFP02543C	FP0R-C32 Control unit with RS232C port	AFP0RC32CT	
	FP0-C32CP	AFP02553C		AFP0RC32CP	
FP0-T32 Control unit with RS232C port, clock / calendar function and 10 k type	FP0-T32CT	AFP02643C	FP0R-T32 Control unit with RS232C port and real clock / calendar function	AFP0RT32CT	
	FP0-T32CP	AFP02653C		AFP0RT32CP	
FP0-S-LINK Control unit with RS232C port	FP0-SL1	AFP02700	Continue to be available		
No corresponding models				FP0R-F32 Control unit with RS232C port	AFP0RF32CT AFP0RF32CP

■ Expansion unit replacement table

FP0
➔ FP0R

Product name	Product No.	Part No.		Product name	Part No.
FP0-E8	FP0-E8X	AFP03003	Order receiving will be discontinued in August 2012.	FP0R-E8	AFP0RE8X
	FP0-E8RS	AFP03023			AFP0RE8RS
	FP0-E8RM	AFP03013			AFP0RE8RM
	FP0-E8YRS	AFP03020			AFP0RE8YRS
	FP0-E8YT	AFP03040			AFP0RE8YT
	FP0-E8YP	AFP03050			AFP0RE8YP
FP0-E16	FP0-E16X	AFP03303		FP0R-E16	AFP0RE16X
	FP0-E16RS	AFP03323			AFP0RE16RS
	FP0-E16RM	AFP03313			AFP0RE16RM
	FP0-E16T	AFP03343			AFP0RE16T
	FP0-E16P	AFP03353			AFP0RE16P
	FP0-E16YT	AFP03340			AFP0RE16YT
	FP0-E16YP	AFP03350	AFP0RE16YP		
FP0-E32	FP0-E32T	AFP03543	FP0R-E32	AFP0RE32T	
	FP0-E32P	AFP03553		AFP0RE32P	

SPECIFICATIONS

Performance specifications (FP0R Control units)

Product type of FP0R control unit		C10 (Relay output type only)	C14 (Relay output type only)	C16 (Transistor output type only)	C32 (Transistor output type only)	T32 (Transistor output type only)	F32 (Transistor output type only)	
Programming method / Control method		Relay symbol / Cyclic operation						
Number of I/O points	No expansion (Control unit only)	10 points [Input: 6, Relay output: 4]	14 points [Input: 8, Relay output: 6]	16 points [Input: 8, Transistor output: 8]	32 points [Input: 16, Transistor output: 16]	32 points [Input: 16, Transistor output: 16]		
	With expansion 1 * Same type of control and expansion units	Max. 58 points	Max. 62 points	Max. 112 points	Max. 128 points	Max. 128 points		
	With expansion 2 * Mix type of relay and transistor units	Max. 106 points	Max. 110 points	Max. 112 points	Max. 128 points	Max. 128 points		
Program memory		EEPROM (no backup battery required)						
Program capacity		16 k steps			32 k steps			
Number of instructions	Basic	110 approx.						
	High-level	210 approx.						
Operation speed	Up to 3,000 steps	Basic instructions: 0.08 µs Min. Timer instructions: 2.2 µs Min. High-level instructions: 0.32 µs (MV instruction) Min.						
	3,001st and later steps	Basic instructions: 0.58 µs Min. Timer instructions: 3.66 µs Min. High-level instructions: 1.62 µs (MV instruction) Min.						
Operation memory	Relay	Internal relay (R)		4,096 points				
		Timer / Counter (T / C)		1,024 points				
	Memory area	Data register (DT)			32,765 words			
		Index register (IX, IY)			14 words (IO to ID)			
Master control relay points (MCR)		256 words						
Number of labels (JMP and LOOP)		256 labels						
Differential points		Equivalent to the program capacity						
Number of step ladder		1,000 stages						
Number of subroutines		500 subroutines						
Special functions	High speed counter	Single-phase: 6 points (50 kHz max. each) 2-phase: 3 channels (15 kHz max. each)*						
	Pulse output	Not available		4 points (50 kHz max. each) Two channels can be controlled individually.*				
	PWM output	Not available		4 points (6 Hz to 4.8 kHz)				
	Pulse catch input / interrupt input	Total 8 points (with high speed counter)						
	Interrupt program	Input: 8 programs (6 programs for C10 only) / Periodic: 1 program / Pulse match: 4 programs						
	Periodical interrupt	In units of 0.5 ms: 0.5 ms to 1.5 sec. / In units of 10 ms: 10 ms to 30 sec.						
	Constant scan	In units of 0.5 ms: 0.5 ms to 600 ms						
	RS232C port	One RS232C port is mounted on each of C10CRS, C10CRM, C14CRS, C14CRM, C16CT, C16CP, C32CT, C32CP, T32CT, T32CP, F32CT and F32CP type (3P terminal block) Transmission speed (Baud rate): 2,400 to 115,200 bits/s, Transmission distance: 15 m 9.8 ft. Communication method: half duplex						
	RS485 port	One RS485 port is mounted on each of C10MRS, C14MRS, C16MT, C16MP, C32MT, C32MP, T32MT, T32MP, F32MT and F32MP type(3P terminal block) Transmission speed (Baud rate): 115.2 kbps (It is possible to change to 19.2 kbps by the setting.), Transmission distance: 1,200 m 3,937 ft. Communication method: half duplex						
Maintenance		Stored program and system register in EEPROM						
	Memory backup	Program and system register			Stored fixed area in EEPROM Counter: 16 points Internal relay: 128 points Data register: 315 words		Backup of the entire area by a built-in secondary battery	Backup of the entire area by FeRAM (without the need for a battery)
		Self-diagnostic function						
		Watchdog timer (690 ms approx.), Program syntax check						
		Real-time clock function						
	Not available							
	Other functions							
	Rewriting in RUN mode, Download in RUN mode (incl. comments), 8-character password setting, and Program upload protection							

* For the limitations while operating units, see the manual.

General specifications (FP0R Control units)

Item	Specifications	
Rated voltage	24 V DC	
Operating voltage range	20.4 to 28.8 V DC	
Allowed momentary power off time	C10, C14, C16	5 ms (at 20.4 V DC), 10 ms (21.6 V DC or higher)
	C32, T32, F32	10 ms (20.4 V DC or higher)
Ambient temperature	0 to +55 °C 32 to +131 °F	
Storage temperature	-40 to +70 °C -40 to +158 °F (-20 °C to +70 °C -4 to +158 °F for T32 only)	
Ambient humidity	10 to 95% RH (at 25 °C 77 °F, no condensation)	
Storage humidity	10 to 95% RH (at 25 °C 77 °F, no condensation)	
Breakdown voltage (Detection current: 5 mA)	Input terminals - output terminals, Output terminals - power and functional ground terminals --- Transistor output: 500 V AC for 1 minute (Relay output: 1,500 V AC for 1 minute) / Input terminals - power and functional ground terminals, Functional ground terminal - power terminal --- Transistor output: 500 V AC for 1 minute (Relay output: 500 V AC for 1 minute) / Output terminals - output terminals (different common terminals) --- Relay output: 1,500 V AC for 1 minute	
Insulation resistance (Test voltage: 500 V DC)	Input terminals - output terminals, input terminals - power and functional ground terminals, output terminals - power and functional ground terminals, functional ground terminal - power terminal --- Transistor output: 100 MΩ minimum (relay output: 100 MΩ minimum) / Output terminals - output terminals (different common terminals) --- Relay output: 100 MΩ minimum	
Vibration resistance	5 to 9 Hz, single amplitude of 3.5 mm, 1 sweep/min; 9 to 150 Hz, constant acceleration of 9.8 m/s ² , 1 sweep/min; for 10 min each in X, Y, and Z directions	
Shock resistance	147 m/s ² or more, 4 times each in X, Y, and Z directions	
Noise immunity	1,000 V (p-p) with pulse widths 50 ns and 1 µs (using a noise simulator) (Power supply terminal)	
Operating condition	Free from corrosive gasses and excessive dust	

Input specifications (Common to control units and expansion units) (As for the limitation on the number of simultaneous ON points, please refer to the manual.)

Item	Specifications	
	Control unit	Expansion unit
Rated input voltage	24 V DC	
Operating voltage range	21.6 to 26.4 V DC	
Rated input current	2.6 mA approx. (at 24 V DC)	4.7 mA approx. (at 24 V DC)
Input impedance	9.1 kΩ approx.	5.1 kΩ approx.
Input points per common	6 points / common (C10), 8 points / common (C14, C16), 16 points / common (C32, T32, F32)	
Min. ON voltage/ON current	19.2 V / 2 mA	
Max. OFF voltage/OFF current	2.4 V / 1.2 mA	
Response time	OFF → ON	20 µs or less * An input time constant (0.1 to 64 ms) can be set.
	ON → OFF	Same as above
Insulation method	Photocoupler	

* Since the response time of X0 to X7 is very fast (for high-speed counter input) the FP0 happens to chattering noise as an input signal. To prevent this, it is recommended that the timer should be put in the ladder program.

SPECIFICATIONS

Output specifications (Common to control units and expansion units)

1. Relay output type (As for the limitation on the number of simultaneous ON points, please refer to the manual.)

Item	Specifications
Output type	1a
Rated control capacity	2 A 250 V AC, 2 A 30 V DC (4.5 A / common)
Response time	OFF → ON: 10 ms approx. ON → OFF: 8 ms approx.
Life time	Mechanical: 2 x 10 ⁷ operations or more
	Electrical: 10 ⁵ operations or more
Surge absorber	None
Output points per common	2 points / common + 1 point / common + 1 point / comon (C10), 4 points / common + 1 point / common + 1 point / comon (C14)

2. Transistor output type

Item	Specifications	
	NPN	PNP
Output type	Open collector	
Rated load voltage	5 to 24 V DC	24 V DC
Load voltage allowable range	4.75 to 26.4 V DC	21.6 to 26.4 V DC
Max. load current	C16, C32, T32 and F32: 0.2 A / point (Max. 14 per common terminal) E16, E32, E8Y and E16Y: 0.3 A / point (Max. 14 per common terminal)	
OFF state leakage current	1 μA or less	
ON state voltage drop	0.2 V DC or less	
Response time	OFF → ON	20 μs or less (Load current: 5 mA or more), 0.1 ms or less (Load current: 0.5 mA or more) (Note)
	ON → OFF	40 μs or less (Load current: 5 mA or more), 0.2 ms or less (Load current: 0.5 mA or more) (Note)
External power supply	Voltage	21.6 to 26.4 V DC
	Current	C16, E16T and E8YT: 30 mA or less C32, T32, F32, E32T and E16Y: 60 mA or less C16, E16P and E8YP: 35 mA or less C32, T32, F32, E32P and E16YP: 70 mA or less
Surge absorber	Zener diode	
Output points per common	8 points / common (C16T), 16 points / common (C32, T32, F32)	
Insulation method	Photocoupler	

Note: For expansion unit: 1 ms or less

I/O circuit diagrams

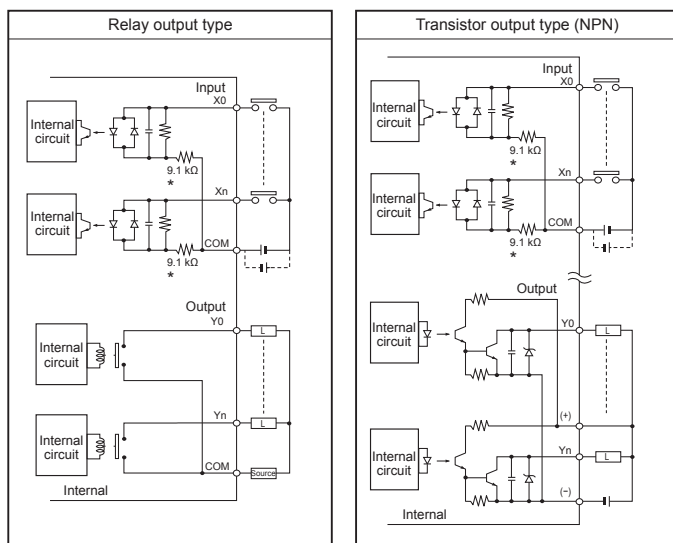

Note: For transistor output types, make sure that the externally supplied voltage between the (+) and (-) terminal is between 21.6 and 26.4 V DC.
* For expansion unit: 5.1 k Ω

Analog unit specifications (FP0 Expansion units)

1. Analog input specifications

Item	Specifications	
	FP0-A21	FP0-A80
Number of input points	2 channels / unit	8 channels / unit (Number of input points can be changed 2, 4, 6 and 8 channels.)
Input range	Voltage range	0 to 5 V (K0 to K4000) (Note 1) -10 to +10 V (K-2000 to K+2000) (Note 1)
	Current range	0 to 20 mA (K0 to K4000) (Note 1)
Resolution	1/4,000 (12 bits)	
Conversion speed	1 ms / channel (Note 2)	
Overall precision	±1 % F.S. or less (0 to 55 °C 32 to 131 °F), ±0.6 % F.S. or less (25 °C 77 °F)	
Input impedance	Voltage range	1 MΩ or more
	Current range	250 Ω
Absolute maximum input	Voltage range	±15 V
	Current range	±30 mA
Insulation method	Between analog input terminal and FP0 internal circuit: optical coupler insulation (non-insulated between channels)	Between analog output terminal and FP0 internal circuit: optical coupler insulation (non-insulated between channels)
	Between analog input terminal and analog I/O unit external power supply: based on insulation type DC/DC converter	Between analog input terminal and A/D converter unit external power supply: based on insulation-type DC/DC converter
Number of I/O contact points	32 input contact points	
Averaging function	None	Can be switched on and off.

Notes: 1) If the analog input value exceeds the upper or lower limit, the digital value will preserve the upper or lower limit.
2) The time shown below is required before the analog data is reflected in the control unit input.

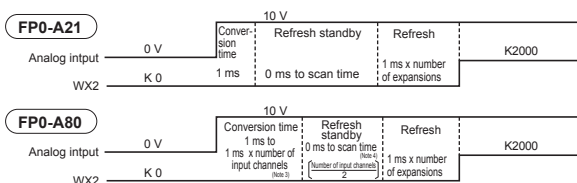

3) Settings value switch for the number of input channel
4) With each one scan of the control unit, the data for two channels will be loaded into control unit. In other words, if the input channel number switch is set to 8-channel, the data in the control unit will be updated once every four scans.

2. Analog output specifications

Item	Specifications		
	FP0-A21	FP0-A04V	FP0-A04I
Number of output points	1 channel / unit	Voltage output 4 channels / units	Current output 4 channels / units
Output range	Voltage range	-10 to +10 V range (K-2000 to K+2000) (Note 1)	---
	Current range	0 to 20 mA (K0 to K4000) (Note 1)	4 to 20 mA (K0 to K4000) (Note 1)
Resolution	1/4,000 (12 bits)		
Conversion speed	500 μs / channel (Note 2)		
Overall precision	±1 % F.S. or less (0 to 55 °C 32 to 131 °F), ±0.6 % F.S. or less (25 °C 77 °F)		
Output impedance	Voltage range	0.5 Ω or less	
	Current range	±10 mA	
Max. output current	Voltage range	---	
	Current range	30 Ω or less	
Absolute output load resistance	Voltage range	1,000 Ω or less	
	Current range	500 Ω or less	
Insulation method (Note 2)	Between analog output terminal and FP0 internal circuit: optical coupler insulation (non-insulated between channels)	Between analog output terminal and analog I/O unit external power supply: based on insulation type DC/DC converter	Between analog output terminal and D/A converter unit external power supply: based on insulation type DC/DC converter
	Between analog output terminal and analog I/O unit external power supply: based on insulation type DC/DC converter	Between analog output terminal and analog input terminal: based on insulation type DC/DC converter	
Number of I/O contact points	16 output contact points	16 input contact points, 32 output contact points (Note 3)	

Notes: 1) If the digital value exceeds the upper or lower limit, D/A conversion will not take place. (Analog output will remain as the previous data.)
2) The time shown below is required to update the actual analog output.

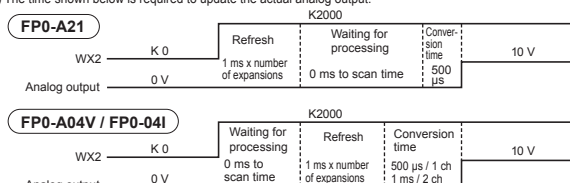

3) The data for two channels will be output to the D/A converter unit with one scan of the control unit.

Thermocouple unit specifications (FP0 Expansion units)

Item	Specifications
Number of input points	4-channel, 8-channel (The number of input points can be changed 2, 4, 6 and 8 channels.)
Input range	Range for K and J: -100.0 to 500.0 °C / -148.0 to 790.0 °F (Note 1)
	Range for T: -100.0 to 400.0 °C / -148.0 to 752.0 °F
	Range for R: 0 to 1500.0 °C / 32.0 to 1590.0 °F (Note 1)
Digital output	K and J (when using °C): K-1000 to K5000 K and J (when using °F): K-1480 to K7900 (Note 1) (When range over using °C: K-1001, K5001 or K8000) (When range over using °F: K-1481, K7901 or K8000) (When the thermocouple broken: K8000) (Note 2) (Until the temperature can be measured at the initial startup: K8001) (Note 3)
	T (when using °C): K-1000 to K4000 T (when using °F): K-1480 to K7520 (When range over using °C: K-1001, K4001 or K8000) (When range over using °F: K-1481, K7521 or K8000) (When the thermocouple broken: K8000) (Note 2) (Until the temperature can be measured at the initial startup: K8001) (Note 3)
	R (when using °C): K0 to K15000 R (when using °F): K320 to K15900 (Note 1) (When range over using °C: K0, K15001 or K16000) (When range over using °F: K0, K15901 or K16000) (When the thermocouple broken: K16000) (Note 2) (Until the temperature can be measured at the initial startup: K16001) (Note 3)

Item	Specifications
Resolution	0.1 °C
Sampling cycle (Note 5)	300 ms: when using 2 channels for an input points (Note 4) 500 ms: when using 4 channels for an input points (Note 4)
	700 ms: when using 6 channels for an input points (Note 4) 900 ms: when using 8 channels for an input points (Note 4)
Overall accuracy	Range for K and J: (-100 to 500 °C): ±0.8 °C or less (-100 to 400 °C): ±0.8 °C or less Range for T: (0 to 99.9 °C): ±3 °C or less (100 to 299.9 °C): ±2.5 °C or less (300 to 1,500 °C): ±2 °C or less
Input impedance	1 MΩ or more
Insulation method	• Between thermocouple input terminals and FP0 internal circuits: Photo-coupler insulation, DC/DC converter insulation • Between thermocouple input terminal channels: PhotoMOS relay insulation
Number of I/O contact points	32 input contact points (Note 6)

Notes:
1) The measurement range available for degree Celsius is not available for degree Fahrenheit, of which the upper-limit measurement is set lower than degree Celsius, since the digital value (temperature value displayed) for degree Fahrenheit is bigger than that for degree Celsius.
2) When the thermocouple is broken, the digital value will become K8000 or K16000 within 70 seconds since broken. Practice in the ladder program a process for avoiding a risk, would be resulting from a broken thermocouple, and exchange the thermocouple.
3) Until the conversion data will be ready after the initial startup was made, the digital value shows K8001 or K16001. Those are not a temperature data. Create a ladder program, so that they are not acquired as a temperature data.
4) The settings of the input channel selection switch.
5) Conversion values for 6-time measurements (6 from the latest 8 measurements, excluding the max. and min.) are averaged, so that it takes time for the digital value to be displayed due to the rapid temperature change.
6) The control unit reads the data for 2 channels per 1 scan by the control unit. Read data by utilizing the sample program given in the product specifications and manual.

SPECIFICATIONS

I/O Link unit specifications (FP0 Expansion units)

Item	Specifications
Communication method	Two-wire, half duplex
Synchronous method	Asynchronous method
Transmission line	2-wire cable (Twisted-pair cable or VCTF 0.75 mm ² x 2C equivalent)
Transmission distance (Total distance)	Max. 700 m 2,297 ft (using twisted-pair cable) Max. 400 m 1,312 ft (using VCTF cable)
Transmission speed (Baud rate)	0.5 Mbits/s
Number of control I/O point per an I/O link unit	64 points (Input: 32 points and Output: 32 points) ^(Note)
Remote I/O map allocation	32X / 32Y
Interface	Conforming to RS485
Transmission error check	CRC (Cyclic Redundancy Check) method

Note: This point number is the number of points that can be linked for inputting and outputting via the host PLC and network MEWNET-F. If the output for the I/O link unit error flag is set to ON, this number becomes 63 points (31 input points and 32 output points).

FP Web-server2 unit specifications (FP0 Expansion units)

Item	Specifications
Communication functions	RS232C ↔ Ethernet conversion (PLC remote programming via Ethernet) E-mail sending function HTTP server function General-purpose communication (Server/Client) PPP server function
Communication interface	RS232C terminal block 3-pin: Mainly used for PLC connection RS232C D-Sub 9-pin: Mainly used for Modem connection 100 BASE-TX (RJ45): Used for Ethernet connection
RS232C communication	Transmission speed: 1,200, 2,400, 4,800, 9,600, 19,200, 38,400, 57,600, 115,200 bits/s Data length: 7 bits / 8 bits, Parity: Even / Odd / None
Ethernet communication	100 Mbits/s (100 BASE-TX: RJ45)
Supported protocol	TCP, UDP, IP, DHCP, FTP, TELNET, HTTP, SMTP, and PPP
Memory size	148 kB approx. (for storing htm files)
Setup method	Setup using FP Web Configurator Tool 2

CC-Link slave unit specifications (FP0 Expansion units)

1. Communication specifications

Item	Specifications
Version	CC-Link Ver.1.10
Communication method	Broadcast polling method
Transmission speed	10 Mbits/s, 5 Mbits/s, 2.5 Mbits/s, 625 kbits/s, 156 kbits/s
Max. transmission distance (Note)	Ver. 1.10 CC-Link cable CC-Link high-performance cable
	CC-Link cable
	100 m 328 ft
	100 m 328 ft
	160 m 525 ft
	150 m 492 ft
	400 m 1,312 ft
	200 m 656 ft
	625 kbits/s
	900 m 2,952 ft
	600 m 1,969 ft
	156 kbits/s
	1,200 m 3,937 ft
	1,200 m 3,937 ft
Interface	RS485
Station type	Remote device station
Number of occupied stations	1 station

Note: Length of the multi-drop connected cables at both ends
The cable length has restrictions in communication speed, CC-Link version, and dedicated cables to be used.
For details concerning the CC-Link, refer to the CC-Link Partner Association.
When an FP0 thermocouple unit is used with an FP0 CC-Link slave unit, the measurement accuracy of the thermocouple unit which is installed on the left of the CC-Link slave unit is as shown in the table below.

Thermocouple		Standard specifications	When CC-Link slave unit with a thermocouple unit
K, J and T		0.8 °C 33.44 °F	2 °C 35.6 °F
R	0 to 99.9 °C 32 to 211.82 °F	3 °C 37.4 °F	6 °C 42.8 °F
	100 to 299.9 °C 212 to 571.82 °F	2.5 °C 36.5 °F	5 °C 41 °F
	300 to 1,500 °C 572 to 2,732 °F	2 °C 35.6 °F	4 °C 39.2 °F

Power supply unit specifications (FP0 Expansion units)

Item	Specifications	
Input	Rated input voltage	100 to 240 V AC
	Variable input voltage range	85 to 264 V AC
	Rated frequency	50/60 Hz
	Frequency range	47 to 63 Hz
	Number of phases	Single-phase
	Inrush current	30 A (0 to P) or less, with cold start
	Leakage current	0.75 mA or less
	Allowable momentary power off time	10 ms or more
Output	Rated voltage	24 V DC
	Voltage accuracy	±5 %
	Rated current	0.7 A ^(Note)
	Output current range	0 to 0.6 A
Protective functions	Ripple voltage	500 mV or less
	Over-current protection	0.63 A or more
	Over-voltage protection	Available

Note: Start up may not be possible if a device with a large inrush current is connected even if below the rated current. In such a case, we recommend suppressing the inrush current by inserting a 1 to 2 Ω resistor between the power supply unit and the device.

Applicable crimp terminals

Manufacturer	Part number	Applicable wiring
JST Mfg. Co., Ltd.	V1.25-M3 (round type)	0.35 to 1.65 mm ²
	V1.25-S3A (fork type)	AWG #22 to #15
	V2-M3 (round type)	1.04 to 2.00 mm ²
	V2-S3A (fork type)	AWG #17 to #14

7.2 mm **0.28 in** or less

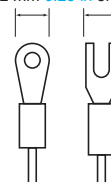

Current consumption

Type of unit	Control unit current consumption (24 V DC)	Expansion unit current consumption (24 V DC)
FP0R control units	C10	100 mA or less
	C14	120 mA or less
	C16	70 mA or less
	C32	—
	T32	90 mA or less
	F32	—
FP0R expansion units	AFP0RE8X	10 mA or less
	AFP0RE8R	10 mA or less
	AFP0RE8YR	10 mA or less
	AFP0RE8YT/P	15 mA or less
	AFP0RE16X	10 mA or less
	AFP0RE16R	20 mA or less
	AFP0RE16T/P	20 mA or less
	AFP0RE16YT/P	25 mA or less
	AFP0RE32T/P	35 mA or less
		—

Type of unit	Control unit current consumption (24 V DC)	Expansion unit current consumption (24 V DC)
FP0 intelligent units	FP0-A21	20 mA or less
	FP0-A80	20 mA or less
	FP0-A04V	20 mA or less
	FP0-A04I	20 mA or less
	FP0-TC4	25 mA or less
	FP0-TC8	—
Communication units	FP0-CCLS	40 mA or less
	FP0-IOL	30 mA or less
	FP-WE2	—
	AFP15402 (C-NET adapter)	50 mA or less
		95 mA or less (at 24 V DC) 240 mA or less (at 12 V DC)

• **Control unit current consumption**
This refers to the current consumed via the power supply connector of the control unit. If expansion units or intelligent units are added, the current is increased by the value indicated above.

• **Expansion unit current consumption**
This refers to the current consumed via the power supply connector of the expansion unit. Units with no value indication don't have a power supply connector.

PRODUCT TYPES

1 Control units

Product name	Built-in memory (Program capacity)	Specifications						Part number
		Number of I/O points		Power supply voltage	Input	Output	Connection type	
FP0R-C10 Control Unit	EEPROM (16 k steps)	10	Input: 6 Output: 4	24 V DC	24 V DC Sink/Source (±common)	Relay: 2 A	Terminal block	AFP0RC10RS
							Molex connector	AFP0RC10RM
FP0R-C10 Control Unit with RS232C port	EEPROM (16 k steps)	10	Input: 6 Output: 4	24 V DC	24 V DC Sink/Source (±common)	Relay: 2 A	Terminal block	AFP0RC10CRS
							Molex connector	AFP0RC10CRM
FP0R-C10 Control Unit with RS485 port	EEPROM (16 k steps)	10	Input: 6 Output: 4	24 V DC	24 V DC Sink/Source (±common)	Relay: 2 A	Terminal block	AFP0RC10MRS
FP0R-C14 Control Unit	EEPROM (16 k steps)	14	Input: 8 Output: 6	24 V DC	24 V DC Sink/Source (±common)	Relay: 2 A	Terminal block	AFP0RC14RS
							Molex connector	AFP0RC14RM
FP0R-C14 Control Unit with RS232C port	EEPROM (16 k steps)	14	Input: 8 Output: 6	24 V DC	24 V DC Sink/Source (±common)	Relay: 2 A	Terminal block	AFP0RC14CRS
							Molex connector	AFP0RC14CRM
FP0R-C14 Control Unit with RS485 port	EEPROM (16 k steps)	14	Input: 8 Output: 6	24 V DC	24 V DC Sink/Source (±common)	Relay: 2 A	Terminal block	AFP0RC14MRS
FP0R-C16 Control Unit	EEPROM (16 k steps)	16	Input: 8 Output: 8	24 V DC	24 V DC Sink/Source (±common)	Transistor NPN: 0.2 A	MIL connector	AFP0RC16T
						Transistor PNP: 0.2 A		AFP0RC16P
FP0R-C16 Control Unit with RS232C port	EEPROM (16 k steps)	16	Input: 8 Output: 8	24 V DC	24 V DC Sink/Source (±common)	Transistor NPN: 0.2 A	MIL connector	AFP0RC16CT
						Transistor PNP: 0.2 A		AFP0RC16CP
FP0R-C16 Control Unit with RS485 port	EEPROM (16 k steps)	16	Input: 8 Output: 8	24 V DC	24 V DC Sink/Source (±common)	Transistor NPN: 0.2 A	MIL connector	AFP0RC16MT
						Transistor PNP: 0.2 A		AFP0RC16MP
FP0R-C32 Control Unit	EEPROM (32 k steps)	32	Input: 16 Output: 16	24 V DC	24 V DC Sink/Source (±common)	Transistor NPN: 0.2 A	MIL connector	AFP0RC32T
						Transistor PNP: 0.2 A		AFP0RC32P
FP0R-C32 Control Unit with RS232C port	EEPROM (32 k steps)	32	Input: 16 Output: 16	24 V DC	24 V DC Sink/Source (±common)	Transistor NPN: 0.2 A	MIL connector	AFP0RC32CT
						Transistor PNP: 0.2 A		AFP0RC32CP
FP0R-C32 Control Unit with RS485 port	EEPROM (32 k steps)	32	Input: 16 Output: 16	24 V DC	24 V DC Sink/Source (±common)	Transistor NPN: 0.2 A	MIL connector	AFP0RC32MT
						Transistor PNP: 0.2 A		AFP0RC32MP
FP0R-T32 Control Unit with RS232C port and Real-time clock function	EEPROM (32 k steps)	32	Input: 16 Output: 16	24 V DC	24 V DC Sink/Source (±common)	Transistor NPN: 0.2 A	MIL connector	AFP0RT32CT
						Transistor PNP: 0.2 A		AFP0RT32CP
FP0R-T32 Control Unit with RS485 port and Real-time clock function	EEPROM (32 k steps)	32	Input: 16 Output: 16	24 V DC	24 V DC Sink/Source (±common)	Transistor NPN: 0.2 A	MIL connector	AFP0RT32MT
						Transistor PNP: 0.2 A		AFP0RT32MP
FP0R-F32 Control Unit with RS232C port and Battery-less automatic all data backup function	EEPROM (32 k steps)	32	Input: 16 Output: 16	24 V DC	24 V DC Sink/Source (±common)	Transistor NPN: 0.2 A	MIL connector	AFP0RF32CT
						Transistor PNP: 0.2 A		AFP0RF32CP
FP0R-F32 Control Unit with RS485 port and Battery-less automatic all data backup function	EEPROM (32 k steps)	32	Input: 16 Output: 16	24 V DC	24 V DC Sink/Source (±common)	Transistor NPN: 0.2 A	MIL connector	AFP0RF32MT
						Transistor PNP: 0.2 A		AFP0RF32MP

Notes: 1) See page 13 for the "Control unit replacement table" of the existing FP0 control units.
2) A power cable (Part number: AFPG805) is supplied with the control units.

2 Expansion units

Product name	Specifications						Part number	
	Number of I/O points		Power supply voltage	Input	Output	Connection type		
FP0R-E8 Expansion Unit	8	Input: 8	—	24 V DC Sink/Source (±common)	—	MIL connector	AFP0RE8X	
	8	Input: 4 Output: 4	24 V DC	24 V DC Sink/Source (±common)	Relay: 2 A	Terminal block	AFP0RE8RS	
						Molex connector	AFP0RE8RM	
	8	Output: 8	24 V DC	—	—	Relay: 2 A	Terminal block	AFP0RE8YRS
	8	Output: 8	—	—	—	Transistor NPN: 0.3 A	MIL connector	AFP0RE8YT
8	Output: 8	—	—	—	Transistor PNP: 0.3 A	MIL connector	AFP0RE8YP	
FP0R-E16 Expansion Unit	16	Input: 16	—	24 V DC Sink/Source (±common)	—	MIL connector	AFP0RE16X	
	16	Input: 8 Output: 8	24 V DC	24 V DC Sink/Source (±common)	Relay: 2 A	Terminal block	AFP0RE16RS	
						Molex connector	AFP0RE16RM	
	16	Input: 8 Output: 8	—	—	24 V DC Sink/Source (±common)	Transistor NPN: 0.3 A	MIL connector	AFP0RE16T
	16	Input: 8 Output: 8	—	—	24 V DC Sink/Source (±common)	Transistor PNP: 0.3 A	MIL connector	AFP0RE16P
	16	Output: 16	—	—	—	Transistor NPN: 0.3 A	MIL connector	AFP0RE16YT
16	Output: 16	—	—	—	Transistor PNP: 0.3 A	MIL connector	AFP0RE16YP	
FP0R-E32 Expansion Unit	32	Input: 16 Output: 16	—	24 V DC Sink/Source (±common)	—	MIL connector	AFP0RE32T	
	32	Input: 16 Output: 16	—	24 V DC Sink/Source (±common)	Transistor PNP: 0.3 A	MIL connector	AFP0RE32P	

Notes: 1) The relay output type expansion units come with a power cable (part number: AFP0581).
(The transistor output type expansion units need no power cable.)

2) The terminal block type relay output units have two terminal blocks (9 pins) made by Phoenix.

Use a 2.5 mm 0.10 inch wide screwdriver. Preferably use the specific terminal block screwdriver (part number: AFP0806, Phoenix type code SZSO, 4 x 2.5 mm 0.10 inch) or equivalent.

3) The connector type relay output units have two connectors made by Nihon Molex (Molex type code 51067-0900, 9 pins). Use the specific Molex connector press-fit tool (part number: AFP0805, Nihon Molex type code 57189-5000) or equivalent.

4) The transistor output units have a press-fit socket for wire-pressed terminal cable and contacts. Use the press-fit tool (part number: AXYS2000FP) for wire-pressed terminal cable.

PRODUCT TYPES

3 Intelligent units

Product name	Specifications	Product number	Part number
FP0 Analog I/O Unit	<Input specifications> Number or channels : 2 channels Input range : Voltage 0 to 5 V, -10 to +10 V (Resolution: 1/4,000) Current 0 to 20 mA (Resolution: 1/4,000)	FP0-A21	AFP0480
	<Output specifications> Number or channels : 1 channel Output range : Voltage -10 to +10 V (Resolution: 1/4,000) Current 0 to 20 mA (Resolution: 1/4,000)		
FP0 A/D Converter Unit	<Input specifications> Number or channels : 8 channels Input range : Voltage 0 to 5 V, -10 to +10 V, -100 to 100 mV (Resolution: 1/4,000) Current 0 to 20 mA (Resolution: 1/4,000)	FP0-A80	AFP0401
FP0 D/A Converter Unit	<Output specifications> Number or channels : 4 channels Output range : (Voltage output type) -10 to +10 V (Resolution: 1/4,000) (Current output type) 4 to 20 mA (Resolution: 1/4,000)	FP0-A04V	AFP04121
		FP0-A04I	AFP04123
FP0 Thermocouple Unit	K, J, T and R thermocouple, Resolution: 0.1°C	FP0-TC4	AFP0420
	K, J, T and R thermocouple, Resolution: 0.1°C	FP0-TC8	AFP0421

4 Link and communication units

Product name	Specifications	Power supply voltage	Product number	Part number
FP0 CC-Link Slave Unit	This unit is for making the FP0 function as a slave station of the CC-Link. Only one unit can be connected to the furthest right edge of the FP0 expansion bus. Note: Accuracy will change if an FP0 thermocouple unit is used at the same time. For details, please refer to the catalog or to the CC-Link Unit manual.	24 V DC	FP0-CCLS	AFP07943
FP0 I/O Link Unit	This is a link unit designed to make the FP0 function as a station to MEWNET-F (remote I/O system).	24 V DC	FP0-IOL	AFP0732
KS1 Signal Converter	RS232C/RS485 data can be easily monitored by LAN.	24 V DC	—	AKS1202
C-NET Adapter (for computer side)	This is an RS485 adapter designed to allow use of the computer link function for connecting to a network-connected PLC via C-NET from a host computer.	100 to 240 V AC	—	AFP8536
		24 V DC	—	AFP8532
FP Web-Server 2 Unit	Unit for connecting FP series or RS232C interface device and Ethernet Web-server function and E-mail sending function	24 V DC	FP-WEB2	AFP0611

5 Power supply unit and others

Product name	Specifications	Product number	Part number
FP0 Power Supply Unit	Input voltage: 100 to 240 V AC Output capacity: 24 V DC, 0.7 A	FP0-PSA4	AFP0634
FP Memory Loader	Data clear type	—	AFP8670
	Data hold type	—	AFP8671

6 Programming tools

Product name	Specifications	Part number
Windows version tool software Control FPWIN Pro Ver.6 (Conforms to IEC61131-3) (FP0R is compatible with Ver. 6.1 or later.)	Japanese version, Full type	CD-ROM for Windows AFPS50160
	English version, Full type	CD-ROM for Windows AFPS50560
Windows version tool software Control FPWIN GR (FP0R is compatible with Ver. 2.8 or later.)	Japanese tool kit with cable	CD-ROM for Windows, with cable (AFC8503) for connection of FP to DOS/V PC AFPS10122
	English version, Full type	CD-ROM for Windows AFPS10520
	English version, Small type	CD-ROM for Windows AFPS11520
	Chinese version, Full type	CD-ROM for Windows AFPS10820
	Korean	CD-ROM for Windows AFPS10920
Handheld programmer	Not available for FP0R. Also the discontinued models (AFP1113V2 and AFP1114V2) are not compatible with FP0R. (They are compatible with FP0.)	

7 Options and maintenance parts

Product name	Specifications	Part number
FP Memory Loader (Note)	Data clear type	AFP8670
	Data hold type	AFP8671
Terminal screwdriver	Relay output type Necessary when wiring terminals block (Phoenix).	AFP0806
Molex connector pressure contact tool	Necessary when wiring relay output type and Molex connectors. (MOLEX: 57189-5000)	AFP0805
Multi-wire connector pressure contact tool	Necessary when wiring transistor output type connectors.	AXY52000FP
FP0 Slim type Mounting plate	Screw-stop attachment plate for FP0 expansion unit. Slim model.	AFP0803 (set for 10)
FP0 Flat type Mounting plate	Screw-stop attachment plate for FP0 control unit. Flat model.	AFP0804 (set for 10)
Relay output Molex type I/O cable	Loose-wiring cable (9 leads) with molex socket attached at one end, AWG20, 0.5 mm ² , 1 set: 2 cables (blue & white).	Length: 1 m 3.3 ft
		Length: 3 m 9.8 ft
Transistor output type I/O Cable	Loose-wiring cable (10 leads) with connectors attached at one end, AWG22, 0.3 mm ² , 1 set: 2 cables (blue & white)	Length: 1 m 3.3 ft
		Length: 3 m 9.8 ft
Flat cable connector set	Flat cable connector set (10 leads)	AFP0808 (including 4 pieces)
Terminal socket	Attaches to relay output and terminal block type. Maintenance part	AFP0802 (2 sokets per pack)
Molex socket	Attaches to relay output and Molex connector types. Maintenance part	AFP0801 (2 sokets per pack)
Wire-press socket	Attaches to transistor output type. Maintenance part	AFP0807 (2 sokets per pack)
Power cable for control unit	Attaches to FP0R control unit. Maintenance part Length: 1 m 3.3 ft	AFPG805 (1 cable per pack)
Power cable for expansion unit	Attaches to expansion unit. Maintenance part Length: 1 m 3.3 ft	AFP0581 (1 cable per pack)

Note: FP0R is compatible with Ver. 2 or later.

DIMENSIONS (Unit: mm in)

Control units and Expansion units * For the relay output type, the terminal block type is listed as the representative type.

Control units

C10RS, C10RM, C10CRS, C10CRM, C10MRS, C14RS, C14RM, C14CRS, C14CRM and C14MRS

Expansion units

E8RS, E8RM, E8YRS, E16RS and E16RM

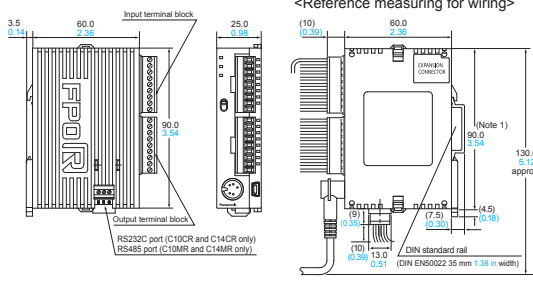

Terminal array

	C10RS/C10RM	C14RS/C14RM	E8RS/E8RM	E16RS/E16RM/E8YRS
Input	X0	X0	X0	X0
	X1	X1	X1	X1
	X2	X2	X2	X2
	X3	X3	X3	X3
	X4	X4	X4	X4
	X5	X5	X5	(NC)
Output	(NC)	(NC)	(NC)	(NC)
	(NC)	(NC)	(NC)	(NC)
	(NC)	(NC)	(NC)	(NC)
	(NC)	(NC)	(NC)	(NC)
	(NC)	(NC)	(NC)	(NC)
	(NC)	(NC)	(NC)	(NC)
	COM	COM	COM	COM

Notes: 1) DIN rail is attached on the center of the unit.
2) The AFPORE8YRS is not equipped with an input terminal block.

Control units

C16T, C16P, C16CT, C16CP, C16MT and C16MP

Expansion units

E16T, E16P, E8X, E8YT and E8YP

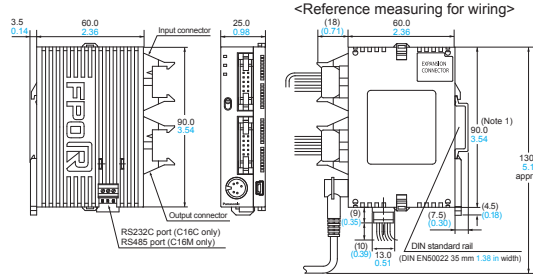

Terminal array

Input (8 points / common)

X0	X1
X2	X3
X4	X5
X6	X7
COM	COM

Output (8 points / common)

Y0	Y1
(NC)	(NC)
(NC)	(NC)
(NC)	(NC)
(NC)	(NC)
(NC)	(NC)
(NC)	(NC)
(NC)	(NC)
(+)	(-)

RS232C port Terminal array

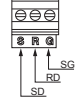

RS485 port Terminal array

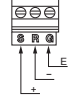

Note: Two COM terminals on the input circuit are connected inside the unit.

Notes: 1) DIN rail is attached on the center of the unit.
2) The AFPORE8X has no output connector.
3) The AFPORE8YT and AFPORE8YP has no input connector.

Control units

C32T, C32CT, C32P, C32CP, C32MT, C32MP, T32CT, T32CP, T32MT, T32MP, F32CT, F32CP, F32MT and F32MP

Expansion units

E32T, E32P, E16X, E16YT and E16YP

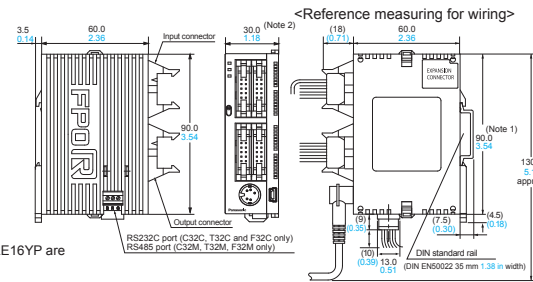

Terminal array

Input (16 points / common)

X0	X1	X8	X9
X2	X3	XA	XB
X4	X5	XC	XD
X6	X7	XE	XF
COM	COM	COM	COM

Output (16 points / common)

Y0	Y1	Y8	Y9
Y2	Y3	YA	YB
Y4	Y5	YC	YD
Y6	Y7	YE	YF
(+)	(-)	(+)	(-)

RS232C port Terminal array

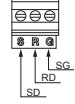

RS485 port Terminal array

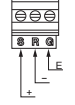

Notes: 1) Four COM terminals on the input circuit are connected inside the unit.
2) Two (+) terminals and two (-) terminals on the output circuit are connected respectively inside the unit.

Notes: 1) DIN rail is attached on the center of the unit.
2) The AFPORE32T, AFPORE32P, AFPORE16X, AFPORE16YT and AFPORE16YP are 25 mm 0.98 in each.
3) The AFPORE16X has no output connector.
4) The AFPORE16YT and AFPORE16YP has no input connector.

FP0 Analog I/O Unit and D/A Converter Unit

FP0 A/D Converter Unit and Thermocouple Unit

FP Web-Server 2 Unit

FP0 Power Supply Unit

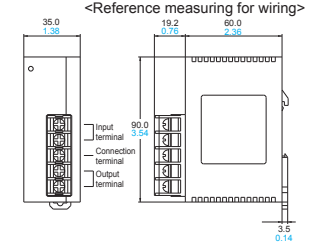
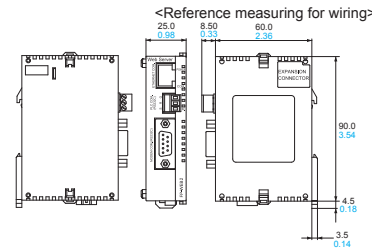
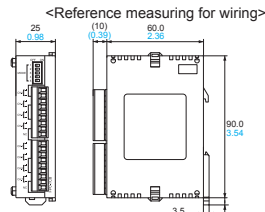
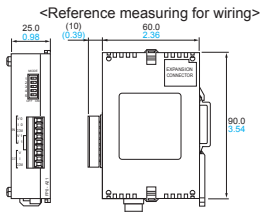

External Dimensions During Expansions

Top view (with DIN rail attached)

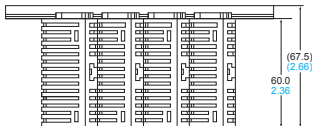

Front view

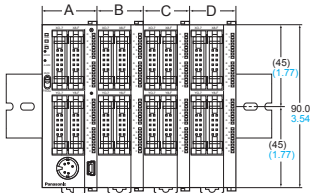

A + B + C + D dimensions (mm in)

Control unit	A + B + C + D dimensions (mm in)			
	A	A→B	A→C	A→D
Control unit only	25	50	75	100
1 expansion unit connected	0.98	1.97	2.95	3.94
2 expansion units connected				
3 expansion units connected				
C10RS C16T				
C10CRS C16CT				
C10RM C16P				
C10CRM C16CP				
C10MRS C16MT				
C14RS C16MP				
C14CRS				
C14RM				
C14CRM				
C14MRS				
C32T C32MT				
C32CT C32MP				
C32P T32MT				
C32CP T32MP				
T32CT F32MT				
T32CP F32MP				
F32CT				
F32CP				