



Where Automation Connects.



RLX2-IHx Series

802.11a, b, g, n

Industrial Hotspots

May 7, 2020

USER MANUAL

Your Feedback Please

We always want you to feel that you made the right decision to use our products. If you have suggestions, comments, compliments or complaints about our products, documentation, or support, please write or call us.

How to Contact Us

ProSoft Technology, Inc.

+1 (661) 716-5100

+1 (661) 716-5101 (Fax)

www.prosoft-technology.com

support@prosoft-technology.com

RLX2-IHx Series User Manual

May 7, 2020

ProSoft Technology®, is a registered copyright of ProSoft Technology, Inc. All other brand or product names are or may be trademarks of, and are used to identify products and services of, their respective owners.

In an effort to conserve paper, ProSoft Technology no longer includes printed manuals with our product shipments. User Manuals, Datasheets, Sample Ladder Files, and Configuration Files are provided at our website:

www.prosoft-technology.com

Content Disclaimer

This documentation is not intended as a substitute for and is not to be used for determining suitability or reliability of these products for specific user applications. It is the duty of any such user or integrator to perform the appropriate and complete risk analysis, evaluation and testing of the products with respect to the relevant specific application or use thereof. Neither ProSoft Technology nor any of its affiliates or subsidiaries shall be responsible or liable for misuse of the information contained herein. Information in this document including illustrations, specifications and dimensions may contain technical inaccuracies or typographical errors. ProSoft Technology makes no warranty or representation as to its accuracy and assumes no liability for and reserves the right to correct such inaccuracies or errors at any time without notice. If you have any suggestions for improvements or amendments or have found errors in this publication, please notify us.

No part of this document may be reproduced in any form or by any means, electronic or mechanical, including photocopying, without express written permission of ProSoft Technology. All pertinent state, regional, and local safety regulations must be observed when installing and using this product. For reasons of safety and to help ensure compliance with documented system data, only the manufacturer should perform repairs to components. When devices are used for applications with technical safety requirements, the relevant instructions must be followed. Failure to use ProSoft Technology software or approved software with our hardware products may result in injury, harm, or improper operating results. Failure to observe this information can result in injury or equipment damage.

Copyright © 2020 ProSoft Technology, Inc. All Rights Reserved.

Printed documentation is available for purchase. Contact ProSoft Technology for pricing and availability.



For professional users in the European Union

If you wish to discard electrical and electronic equipment (EEE), please contact your dealer or supplier for further information.



Warning – Cancer and Reproductive Harm – www.P65Warnings.ca.gov

Important Safety Information

The following Information and warnings pertaining to the radio module must be heeded:

WARNING – EXPLOSION HAZARD – DO NOT REPLACE ANTENNAS UNLESS POWER HAS BEEN SWITCHED OFF OR THE AREA IS KNOWN TO BE NON-HAZARDOUS.

"THIS DEVICE CONTAINS ONE OF THE FOLLOWING TRANSMITTER MODULES:

FCC ID: OQ7IHG, RYK-WMIA199NI, NKRDCMA82, SWX-XR5

PLEASE SEE FCC ID LABEL ON BACK OF DEVICE."

"THIS DEVICE USES AN INTERNAL COMPACT FLASH RADIO MODULE AS THE PRIMARY RADIO COMPONENT. THE COMPACT FLASH RADIO MODULE DOES NOT HAVE AN FCC ID LABEL. THE COMPACT FLASH RADIO MODULE HAS NO USER SERVICEABLE PARTS."

"THIS DEVICE COMPLIES WITH PART 15 OF THE FCC RULES. OPERATION IS SUBJECT TO THE FOLLOWING TWO CONDITIONS: (1) THIS DEVICE MAY NOT CAUSE HARMFUL INTERFERENCE, AND (2) THIS DEVICE MUST ACCEPT ANY INTERFERENCE RECEIVED, INCLUDING INTERFERENCE THAT MAY CAUSE UNDESIRE OPERATION."

"CHANGES OR MODIFICATIONS NOT EXPRESSLY APPROVED BY THE PARTY RESPONSIBLE FOR COMPLIANCE COULD VOID THE USER'S AUTHORITY TO OPERATE THE EQUIPMENT."

"This device is configured for operation in the USA during manufacturing. These configuration controls are not present in the software with which the unit is shipped; therefore the end user cannot change the max power settings or the country/region. The models sold & shipped within the U.S. are identified within the model number with –A as part of the identifier."

China RoHS Hazardous Material Declaration Table

部件名称 Component Name	有害物质 Hazardous Substances					
	鉛 Lead (Pb)	汞 Mercury (Hg)	鎘 Cadmium (Cd)	六价铬 Hexavalent Chromium (Cr(VI))	多溴联苯 Polybrominated Biphenyls (PBB)	多溴二苯醚 Polybrominated Diphenyl Ethers (PBDE)
印刷电路板组件 Printed Circuit Board Assemblies	X	O	O	O	O	O
金属部件 Metal Components	X	O	O	O	O	O
电池 Battery	O	O	O	O	O	O
本表格依据SJ/T 11364的规定编制。 This table is made per guidance of SJ/T 11364 O: 表示该有害物质在该部件所有均质材料中的含量均在GB/T 26572规定的限量要求以下。 O: Indicates that this hazardous substance contained in all of the homogeneous materials for the part is below the limit requirement in GB/T 26572.						
X: 表示该有害物质至少在该部件的某一均质材料中的含量超出GB/T 26572规定的限量要求。 X: Indicates that this hazardous substance contained in at least one of the homogeneous materials used for this part is above the limit requirement in GB/T 26572.						

WARNING – EXPLOSION HAZARD – SUBSTITUTION OF COMPONENTS MAY IMPAIR SUITABILITY FOR CLASS I, DIV.2

WARNING – EXPLOSION HAZARD – WHEN IN HAZARDOUS LOCATIONS, TURN OFF POWER BEFORE REPLACING OR WIRING MODULES

WARNING – EXPLOSION HAZARD – DO NOT DISCONNECT EQUIPMENT UNLESS POWER HAS BEEN SWITCHED OFF OR THE AREA IS KNOWN TO BE NON-HAZARDOUS

Industry Canada Requirements:

"THIS DEVICE HAS BEEN DESIGNED TO OPERATE WITH AN ANTENNA HAVING A MAXIMUM GAIN OF 24 dB. AN ANTENNA HAVING A HIGHER GAIN IS STRICTLY PROHIBITED PER REGULATIONS OF INDUSTRY CANADA. THE REQUIRED ANTENNA IMPEDANCE IS 50 OHMS."

"TO REDUCE POTENTIAL RADIO INTERFERENCE TO OTHER USERS, THE ANTENNA TYPE AND ITS GAIN SHOULD BE CHOSEN SUCH THAT THE EQUIVALENT ISOTROPICALLY RADIATED POWER (EIRP) IS NOT MORE THAN THAT REQUIRED FOR SUCCESSFUL COMMUNICATION."

"THE INSTALLER OF THIS RADIO EQUIPMENT MUST INSURE THAT THE ANTENNA IS LOCATED OR POINTED SUCH THAT IT DOES NOT EMIT RF FIELD IN EXCESS OF HEALTH CANADA LIMITS FOR THE GENERAL POPULATION; CONSULT SAFETY CODE 6, OBTAINABLE FROM HEALTH CANADA."

Agency Approvals & Certifications

Please visit our website: www.prosoft-technology.com

RLX2-IHNF, RLX2-IHA, RLX2-IHG, RLX2-IHW

This equipment is Suitable For Use in Class I, Division 2, Groups A, B, C, D or Non-Hazardous Location Only.

WARNING – EXPLOSION HAZARD – Substitution of Any Components May Impair Suitability for Class I, Division 2.

WARNING – EXPLOSION HAZARD – Do not disconnect equipment unless power has been removed or the area is known to be non-hazardous.

The unit is to be connected only to PoE networks without routing to the outside plant.

WARNING – EXPLOSION HAZARD – The SIM Card/Personality Module connection is for initial setup and maintenance only. Do not use, connect, or disconnect unless area is known to be non-hazardous. Connection or disconnection in an explosive atmosphere could result in explosion.

Class 2 Power

Device is an open-type and is to be installed in an enclosure suitable for the environment.

RLX2-IHNF-W

The equipment shall be properly grounded with the external ground screw provided connected to building ground as well as the antenna coaxial screen of the connector shall be grounded.

The common or earth side of the circuit is connected to the screen of the coaxial cable and to all accessible parts and circuits.

Shall be installed in Restricted Access Location Only.

SUITABLE FOR USE IN CLASS I, DIVISION 2, GROUPS A, B, C AND D HAZARDOUS LOCATIONS, OR NONHAZARDOUS LOCATIONS ONLY.

WARNING - EXPLOSION HAZARD - DO NOT DISCONNECT EQUIPMENT WHILE THE CIRCUIT IS LIVE OR UNLESS THE AREA IS KNOWN TO BE FREE OF IGNITABLE CONCENTRATIONS.

WARNING - EXPLOSION HAZARD - SUBSTITUTION OF COMPONENT MAY IMPAIR SUITABILITY FOR CLASS I, DIVISION 2.

WARNING – DO NOT CONNECT OR DISCONNECT WHEN ENERGIZED.

Antennas are to be installed in accordance with Control Drawing 06/2514

Unit does not comply to the cable assy requirements of ISA 12.12.01 but does comply with the ATEX standards IEC60079-0 & IEC60079-15. In ATEX environments, do not connect/disconnect unless area is known to be non-hazardous.

Unit must be wired with Phoenix Contact M12 Cable Assemblies, Model Series SAC-HZ-XX-XX-XX/XX-XXX/XXXXXXXX, that are suitable for use in Class 1, Division 2, Groups A, B, C, and D Hazardous Locations.

RLX2-IHNF-WC

The equipment shall be properly grounded with the external ground screw provided connected to building ground as well as the antenna coaxial screen of the connector shall be grounded.

The common or earth side of the circuit is connected to the screen of the coaxial cable and to all accessible parts and circuits.

Shall be installed in Restricted Access Location Only.

SUITABLE FOR USE IN CLASS I, DIVISION 2, GROUPS A, B, C AND D HAZARDOUS LOCATIONS, OR NONHAZARDOUS LOCATIONS ONLY.

WARNING - EXPLOSION HAZARD - DO NOT DISCONNECT EQUIPMENT WHILE THE CIRCUIT IS LIVE OR UNLESS THE AREA IS KNOWN TO BE FREE OF IGNITABLE CONCENTRATIONS.

WARNING - EXPLOSION HAZARD - SUBSTITUTION OF COMPONENT MAY IMPAIR SUITABILITY FOR CLASS I, DIVISION 2.

WARNING – DO NOT CONNECT OR DISCONNECT WHEN ENERGIZED

Antennas are to be installed in accordance with Control Drawing 06/2514

RLX2-IHNF-TW

低功率射頻警語：

DGT Warning Statement

第十二條

經型式認證合格之低功率射頻電機，非經許可，公司、商號或使用者均不得擅自變更頻率、加大功率或變更原設計之特性及功能。

Article 12

Without permission, any company, firm or user shall not alter the frequency, increase the power, or change the characteristics and functions of the original design of the certified lower power frequency electric machinery.

第十四條

低功率射頻電機之使用不得影響飛航安全及干擾合法通信；經發現有干擾現象時，應改善至無干擾時方得繼續使用。前項合法通信，指依電信法規定作業之無線電通信。低功率射頻電機須忍受合法通信或工業、科學及醫療用電波輻射性電機設備之干擾。

Article 14

The application of low power frequency electric machineries shall not affect the navigation safety nor interfere a legal communication, if an interference is found, the service will be suspended until improvement is made and the interference no longer exists.

Recommended Antennas

ProSoft offers a variety of Antennas and Cables for use with your RadioLinX device. The following is a sample of available antennas. For a complete list and description, please visit our website: www.prosoft-technology.com.

ProSoft Part Number	Max Gain and Type
A2402S-OA	2 dBi Omni RP-SMA articulating 2.4GHz
A2403NBH-OC	3 dBi Omni N-BH jack whipless 2.4GHz
A2404NBHW-OC	4 dBi Omni N BH jack low profile 2.4GHz
A2404NJ-OC-B	4 dBi Omni N jack collinear with mounting hardware 2.4GHz
A2405S-OA	5 dBi Omni RP-SMA articulating 2.4GHz
A2406NJ-OC-B	6 dBi Omni N jack collinear with mounting hardware 2.4GHz
A2406NJ-OCD	6dBi Omni N jack heavy duty collinear with mounting hardware 2.4GHz
A2406S3-DP	6dBi Panel RP-SMA MIMO antenna with 3 foot pigtail 2.4GHz
A2408NJ-DP	8 dBi Directional patch panel N jack with mounting hardware 2.4GHz
A2408NJ-OC-B	8 dBi Omni N jack collinear with mounting hardware 2.4GHz
A2409NJ-OCD	9 dBi Omni N jack heavy duty collinear with mounting hardware 2.4GHz
A2409NJ-OH	9 dBi Omni, horizontal polarized, N jack 2.4GHz
A2410NJ-DY	10 dBi Directional N jack Yagi with mounting hardware 2.4GHz
A2412NJ3-DP	12dBi Panel N-Jack MIMO antenna 2.4GHz
A2413NJ-DP	13 dBi Directional patch panel N jack with mounting hardware 2.4GHz
A2415NJ-DY	15 dBi Directional N jack Yagi with mounting hardware 2.4GHz
A2415NJ-OC	15dBi Omni N jack collinear antenna with mounting hardware 2.4GHz
A2416NJ-DS-A	16 dBi Directional 120 degree sector N jack
A2419NJ-DB	19 dBi Directional N jack parabolic with mounting hardware 2.4GHz
A2419NJ-DP	19 dBi patch panel N jack with mounting hardware 2.4GHz
A2424NJ-DB-A	24 dBi Directional N jack parabolic with mounting hardware 2.4GHz
A2500NBH-OC	Unity Omni N BH low profile collinear antenna 2.4/5GHz
A2502NP-OA	2/3 dBi Omni N Plug articulating 2.4 / 5 GHz Antenna
A2502S-OA	2dBi omni RP-SMA articulating 2.4/5GHz
A2503NBH-OC	2.4 / 5 GHz 3 dBi Omnidirectional Bulkhead Mount Antenna
A2503S3-O	3/4dBi Omni RP-SMA MIMO antenna with 3 foot pigtail 2.4/5GHz
A2504NBHW-OC	4 dBi Omni N BH low profile collinear antenna 2.4/5GHz
A2504NP3-O-6	4 dBi Omni MIMO antenna with N connector and 6 foot pigtail 2.4/5 GHz
A2504S-OA	4dBi omni RP-SMA articulating 2.4/5GHz
A2504S-OBH	4dBi Omni RP-SMA whip< BH mount 2.4/5GHz
A2504S3-O	4 dBi Omni RP-SMA MIMO antenna with 15 foot pigtail 2.4/5GHz
A2504S3-O-1	4 dBi Omni RP-SMA MIMO antenna with 1 foot pigtail 2.4/5GHz
A2504S3-O-6	4 dBi Omni RP-SMA MIMO antenna with 6 foot pigtail 2.4/5GHz
A2504S3-O-8	4 dBi Omni RP-SMA MIMO antenna with 8 foot pigtail 2.4/5 GHz
A2505NJ-OC	5/7 dBi Omni N jack 2.4-2.5 GHz & 4.94-5.925 GHz Antenna

ProSoft Part Number	Max Gain and Type
A2506NJ-OC	6/8dBi omni N jack collinear with mounting hardware 2.4/5GHz
A2506NJ3-O	6dBi Omni N-Jack Single MIMO antenna with 3 foot pigtail 2.4/5GHz
A2506S3-DP	6dBi Panel RP-SMA MIMO Antenna with 3 foot pigtail 2.4/5GHz
A2507NP-DP	7 dBi directional N Plug panel with mounting hardware 2.4/5GHz Antenna
A2512NJ3-DP	12 dBi Panel MIMO antenna 2.4/5 GHz Antenna
A5002S-O-5	2.5 dBi Omni RP-SMA Dome antenna with 5 foot pigtail 5GHz
A5003S-OBH	3dBi Omni RP-SMA bulkhead mount with 5' LMR195 pigtail 5GHz
A5006NJ-OC	6dBi omni N jack collinear with mounting hardware 5GHz
A5007NBH-DH	5GHz 7dBi Bulkhead Antenna
A5007S3-DH	7dBi Hybrid Directional RP-SMA MIMO antenna with 3 foot pigtail 5GHz
A5007S3-DP	7dBi Panel RP-SMA MIMO antenna with 3 foot pigtail 5GHz
A5009NJ-OC	9dBi omni N jack collinear with mounting hardware 5GHz
A5016NJ-DS	16 dBi Directional 90 degree sector N jack with mounting hardware 5GHz
A5016NJ2-DS	16 dBi 120 degree Sector N-Jack 2X MIMO antenna 5GHz
A5017NJ2-DS	17dBi Sector N-Jack 2X MIMO antenna 5GHz
A5017NJ3-DP	17dBi Panel N-Jack MIMO antenna 5GHz
A5019NJ-DP	20 dBi directional N jack panel with mounting hardware 5GHz
A5019NJ2-DP	19dBi Panel N-Jack 2X MIMO antenna 5GHz
A5019NJ2-DS	19dBi Sector, 120degree N-Jack 2X MIMO antenna 5GHz
A5020NJ2-DS	20dBi Sector N-Jack 2X MIMO antenna 5GHz
A5023NJ-DP	19/23 dBi directional N jack panel with mounting hardware 5GHz
A5024NJ-DP	24dBi directional N jack panel with mounting hardware 5GHz
A5812NJ-OC	12dBi omni N jack collinear with mounting hardware 5.8GHz
A5829NJ-DB	29dBi directional N jack parabolic with mounting hardware 5.8GHz

Note: An adapter may be needed for some of the listed antennas to operate with certain radios.

Antenna Spacing Requirements for User Safety

It is important to keep the radio's antenna a safe distance from the user. To meet the requirements of FCC part 2.1091 for radio frequency radiation exposure, this radio must be used in such a way as to guarantee at least 20 cm between the antenna and users. Greater distances are required for high-gain antennas. The FCC requires a minimum distance of $1 \text{ mW} \cdot \text{cm}^2$ power density from the user (or 20 cm, whichever is greater).

Note: If a specific application requires proximity of less than 20 cm, the application must be approved through the FCC for compliance to part 2.1093.

Contents

Your Feedback Please.....	2
How to Contact Us	2
Content Disclaimer.....	2
Important Safety Information.....	3
Industry Canada Requirements:	4
Agency Approvals & Certifications.....	4
Please visit our website: www.prosoft-technology.com	4
RLX2-IHNF, RLX2-IHA, RLX2-IHG, RLX2-IHW	4
RLX2-IHNF-W	5
RLX2-IHNF-WC	5
RLX2-IHNF-TW.....	6
Recommended Antennas	7
Antenna Spacing Requirements for User Safety	8
1 Start Here	14
1.1 Before You Begin	14
1.2 About This Manual	14
1.3 About RLX2-IHx Series Industrial Hotspot Products.....	14
1.3.1 Product Overview	14
1.3.2 General Features	16
1.3.3 Antenna Port Connections	17
1.4 Package Contents	19
1.4.1 RLX2-IHA, -IHG, -IHNF, -IHW.....	19
1.4.2 RLX2-IHNF-W	19
1.4.2.1 RLX2-IHNF-W Cables (sold separately)	20
1.4.3 RLX2-IHNF-WC.....	20
1.4.4 Industrial Hotspot Bench Test Kit (RLX-IHBTK)	21
1.5 Installing the RadioLinx Industrial Hotspot Browser.....	21
1.5.1 IH Browser System Requirements	21
1.5.2 Installing IH Browser Software	22
1.5.3 Starting the IH Browser	22
2 Network Planning	23
2.1 Installing the ProSoft Wireless Designer.....	24
2.2 Installation Questions	24
2.3 Planning the Physical Installation.....	25
2.4 ProSoft Wireless Designer	25
2.4.1 Designer Functional Specifications	27
2.5 Testing the Network Installation	27
2.5.1 Improving Signal Quality	28
2.6 Detecting 802.11 Access Points	29
3 RLX2-IHx Series Quick Setup	30
3.1 Preparing the Configuration Environment.....	30
3.2 Making Power and Data Connections.....	31
3.2.1 RLX2-IHW, IHNF, IHG, IHA Radio Connections.....	31
3.2.2 RLX2-IHNF-W Radio Connections.....	31

- 3.2.3 RLX2-IHNF-WC Radio Connections..... 34
- 3.3 Radio Power-Up..... 37
- 3.4 Using the IH Browser to Configure Radios 37
 - 3.4.1 Viewing the Radios in the IH Browser 37
 - 3.4.2 Refreshing the Display in the IH Browser 38
 - 3.4.3 Setting the Radio IP Address in the IH Browser 38
 - 3.4.4 Assigning a Temporary IP Address 39
- 3.5 Configuring a Radio - Getting Started 40
 - 3.5.1 Connecting to the Radio Configuration Interface..... 40
 - 3.5.2 Configuring a Master Radio 43
 - 3.5.3 Configuring a Repeater Radio 45
 - 3.5.4 Configuring a Bridging Client Radio..... 47
 - 3.5.5 Configuring a Client Radio..... 50
- 3.6 Viewing a Radio's Configuration 52
- 3.7 Replacing an Existing Radio..... 53

4 Configuring a Radio - Detailed Configuration 54

- 4.1 Connecting to the Radio Configuration Interface..... 54
 - 4.1.1 Read-Only Fields 55
 - 4.1.2 Configuration Help 56
 - 4.1.3 Apply Changes..... 58
 - 4.1.4 Cancelling Changes..... 58
 - 4.1.5 Factory Defaults..... 58
- 4.2 Viewing Radio Status..... 59
 - 4.2.1 Viewing Available Parents for a Radio 61
 - 4.2.2 Viewing the Radio Address Table 63
 - 4.2.3 Viewing the Radio Port Status 64
- 4.3 Configuring Basic Settings..... 66
 - 4.3.1 Basic Wireless Settings 67
 - 4.3.2 Wireless Security Settings 70
 - 4.3.3 Access Settings 78
- 4.4 Configuring Advanced Settings 79
 - 4.4.1 Advanced Wireless Settings 80
 - 4.4.2 Roam Control Settings..... 85
 - 4.4.3 Location Services Settings 88
 - 4.4.4 Personality Module Settings 89
 - 4.4.5 Changing Password Settings..... 91
- 4.5 Configuring Parent Link Settings 92
 - 4.5.1 Parent Selection Method Settings 93
 - 4.5.2 Repeater Parameters Settings 94
- 4.6 Configuring Advanced Network Settings 97
 - 4.6.1 IGMP Settings..... 98
 - 4.6.2 Other Network Protocols..... 99
 - 4.6.3 STP Settings 101
 - 4.6.4 SNMP Agent 105
 - 4.6.5 Cable Break Detection 106
- 4.7 Configuring Serial Settings 107
 - 4.7.1 Serial Encapsulation Mode Setting..... 108
 - 4.7.2 Remote IP Settings 109
 - 4.7.3 Packet Delineation Settings..... 110
 - 4.7.4 Port Settings 112
- 4.8 Configuring Quality of Service (QoS) Settings 113
- 4.9 Configuring VLAN Settings 115

4.10	Configuring NAT Settings.....	117
4.11	About This Unit.....	120
5	Using the IH Browser to Manage your Radios	121
5.1	Viewing the Radios in the IH Browser	121
5.1.1	Refreshing the Display in the IH Browser	122
5.1.2	Defining the Scan Parameters in the IH Browser	122
5.1.3	Freezing the Display in the IH Browser.....	123
5.1.4	Changing IH Browser Columns in List View.....	123
5.1.5	Switching between List and Topology Views	123
5.1.6	Printing the View in the IH Browser.....	128
5.1.7	Importing and Exporting IH Browser Data.....	128
5.1.8	Hiding the Toolbar and Status Bar in the IH Browser	129
5.2	Viewing the Radio Properties	129
5.3	Setting the Radio IP Address in the IH Browser	131
5.4	Assigning a Temporary IP Address.....	132
5.5	Viewing Additional Data in the IH Browser.....	133
5.6	Connecting to the Radio Configuration Interface	133
5.7	Updating the Radio Firmware	135
5.8	Pinging Devices on the Network	136
5.8.1	Setting the Ping Parameters	137
5.9	Viewing Network Data in the IH Browser	138
5.9.1	Viewing Wireless Clients in the IH Browser	138
5.9.2	Viewing Ethernet Nodes in the IH Browser	139
5.9.3	Viewing the Scan List in the IH Browser	140
5.9.4	Viewing the Port Table in the IH Browser	142
5.9.5	Viewing the Radio Event Log in the IH Browser	143
5.9.6	Viewing Parent Radios in the IH Browser	145
5.10	Extracting Serial Logs from RLX2-IHx Radios	146
5.10.1	Serial Logging Dialog	146
5.10.2	Starting the Logging Session	151
5.11	Settings Viewer	153
5.11.1	Select SSID	154
5.11.2	Display View	154
5.11.3	Save Settings Button.....	163
5.11.4	Generate Report Button	164
5.12	Foreign AP Detection	166
5.12.1	Adding APs to the Whitelist.....	170
5.12.2	Removing APs from the Whitelist.....	172
5.12.3	Forcing a Scan	172
5.12.4	Foreign AP Detection Settings	173
5.12.5	Session Log.....	175
5.12.6	Hiding the Foreign AP Detection window.....	176
6	Diagnostics and Troubleshooting	177
6.1	Checking the Ethernet Cable	177
6.2	LED Display.....	178
6.3	Resetting a RLX2-IHx series Radio	180
6.3.1	Resetting the RLX2-IHNF-W and RLX2-IHNF-WC to Defaults.....	180
6.3.2	Resetting All Other Radios.....	181
6.4	Unable to scan for AP's error message.....	181
6.5	Finding Missing Radios	182

7	Appendix A - Adding a Radio to RSLogix 5000	183
7.1	Adding the Radio to RSLogix 5000	183
7.2	Importing the Add-On Instruction	187
7.3	RLX2 Controller Tags	191
7.3.1	RLX2.CONTROL	191
7.3.2	RLX2.STATUS	192
8	Appendix B - Radio Hardware	194
8.1	Radio Power Requirements (RLX2-IHNF-W)	194
8.2	Radio Power Requirements (All other radios)	196
8.3	Ethernet Cable Specifications	198
8.4	Ethernet Cable Configuration	199
8.4.1	Ethernet Cable Configuration (RLX2-IHNF-W)	199
8.4.2	Ethernet Cable Configuration (all other radios)	200
9	Appendix C - RLX2-IHx 5 GHz Radio DFS Support	201
9.1	DFS Radio Operations	201
9.1.1	Selecting a DFS 5 GHz Channel	202
10	Appendix D - RLX2-IHx series Virtual LAN (VLAN) Functionality	205
10.1	Transparent Support of VLAN Tags (802.1Q)	205
10.2	Port/Radio-based VLAN Tagging with Managed Switches	206
10.3	Port/Radio-based VLAN Tagging without Managed Switches	207
11	Appendix E - EtherNet/IP and Modbus TCP/IP Support	208
11.1	Modbus TCP/IP Server Support	208
11.1.1	Modbus Memory Map Diagnostic Information	208
11.2	EtherNet/IP™ Server Support	210
12	Appendix F - Master Channel-Frequency Table	213
13	Appendix G - Antenna Configuration	215
13.1	Antennas	215
13.1.1	Control Drawing	216
13.1.2	Antenna Pattern	218
13.1.3	Antenna Gain	218
13.1.4	Antenna Polarity	219
13.2	Antenna Types	219
13.2.1	Whip Antennas	219
13.2.2	Collinear Array Antennas	220
13.2.3	Yagi Array Antenna	221
13.2.4	Parabolic Reflector Antennas	222
13.3	RLX2-IHx Approved Antennas	222
13.3.1	Approved Antenna Table	223
13.3.2	Approved Antennas in Europe/CE	223
13.3.3	Approved Antennas in Mexico	224

13.3.4	Approved Antennas with Power Amp.....	224
13.4	Antenna Location, Spacing, and Mounting	225
14	Appendix H - FCC Emission Regulations	226
14.1	2.4 GHz Band, Point-To-Multipoint	226
14.2	2.4 GHz Band, Point-To-Point.....	226
14.3	5 GHz Bands, Point-To-Multipoint.....	227
14.4	5 GHz Bands, Point-To-Point.....	227
15	Appendix I - Compatibility with ProSoft RLXIB Series Radios	228
16	Appendix J - Detailed Radio Specifications	230
16.1	RLX2-IHA Detailed Specifications.....	230
16.2	RLX2-IHG Detailed Specifications	231
16.3	RLX2-IHNF, -W, -WC Detailed Specifications	232
16.4	RLX2-IHW Detailed Specifications.....	234
17	Appendix K - Application Examples	235
18	Support, Service & Warranty	237
18.1	Contacting Technical Support	237
18.2	Warranty Information.....	237
19	Glossary of Terms	238
Index		248

1 Start Here

1.1 Before You Begin

For most applications, the installation and configuration steps described in the following topics work without additional programming. ProSoft Technology strongly recommends that you complete the steps in this chapter before developing a custom application.

1.2 About This Manual

This manual covers the entire RadioLinx® RLX2-IHx series Industrial Hotspot™ series of radio products. There are six models available in this product line:

Model	Standards	Maximum Output Power
RLX2-IHA	IEEE 802.11a	24 dBm (250 mW)
RLX2-IHG	IEEE 802.11b/g	24 dBm (250 mW)
RLX2-IHNF	IEEE 802.11a/b/g/n	17 dBm (50 mW) per antenna
RLX2-IHNF-W	IEEE 802.11a/b/g/n	17 dBm (50 mW) per antenna
RLX2-IHNF-WC	IEEE 802.11a/b/g/n	17 dBm (50mW) per antenna
RLX2-IHW	IEEE 802.11a/b/g	20 dBm (100 mW)

Although they have different operating frequencies and output power levels, these radios all operate in a similar fashion. Different models operating on common frequencies can communicate with each other. Furthermore, RLX2-IHx series radios can communicate with ProSoft Technology's legacy RLXIB series of radios (except the RLXIB-IHN). See *Appendix I - Compatibility with ProSoft RLXIB Series Radios* (page 227) for details on the specific differences between the RLX2-IHx series and RLXIB series products.

1.3 About RLX2-IHx Series Industrial Hotspot Products

1.3.1 Product Overview

The RLX2-IHx series radio is an industrial high-speed Ethernet radio. Use it in place of Ethernet cables to save money, extend range, and make connections that may not otherwise be feasible. The radio operates as a wireless Ethernet switch. Any data that can be sent over a wired network can also be sent over the radio.

The RLX2-IHx series radio series is certified for unlicensed operation in the United States, Canada, Europe and other approved countries at 2.4 and 5 GHz. Contact ProSoft Technology for a list of currently approved antennas. With approved high-gain antennas, the radios can achieve distances over 5 miles with line-of-site between them. Multiple repeaters can be used to extend this range to far greater distances.

A highly reliable wireless network can be developed by creating redundant wireless paths. Multiple master radios can be installed without any special programming or control. Repeater radios can connect to any master at any time; if one master goes down, the repeater connects to another. Likewise, if a repeater goes down, any repeater that was connected to it can reconnect to a different repeater, keeping the network intact. Creating large, self-healing tree-like networks can be done in this fashion. Fully redundant paths are possible because the Spanning Tree protocol in the radios disables and enables paths as necessary to avoid Ethernet loops, which would otherwise halt communications. In addition to acting as a switch, every master or repeater radio in an RLX2-IHx series wireless network can simultaneously act as an 802.11 access point. This allows 802.11 Wi-Fi clients to connect and roam between radios for monitoring of the wireless network or general network access. (An example of an 802.11 client is a laptop with Wi-Fi™). The RLX2-IHx series has a special client mode that allows connection of any Ethernet device to any existing 802.11 access point, regardless of the brand.

Note: Wi-Fi is a trademark of the Wi-Fi Alliance, used to describe the underlying technology of wireless local area networks (WLAN) based on the IEEE 802.11 specifications.

A high level of security is inherent with AES (Advanced Encryption Standard) encryption. TKIP (Temporal Key Integrity Protocol) is also available. If necessary, adding WEP128 or WEP64 (Wired Equivalent Protocol) encryption in addition to AES or TKIP for clients that do not support AES can be done. If desired, a simple Media Access Control (MAC) filter table also restricts the radios or clients that can link to a selected radio according to the MAC IDs entered in the table.

The radio is designed for industrial applications with a metal enclosure, DIN-rail mounting, and shock and vibration tested to IEC 60068.

The RLX2-IHx series radio series is easy to use. Access the built-in webpages with any web browser to configure the radio. Also, an SNMP manager can be used for configuration. The radio comes with a Windows-based utility called *IH Browser*. It finds all the radios on the network and lists information about them. A topology view in the IH Browser shows how the wireless network is linked together at any point in time. Firmware updates can be done at anytime from anywhere on the network. This includes over the wireless link or over the Internet.

ProSoft Technology radios can easily be installed into new or existing systems.

You can download sample programs, utilities, firmware images, and documentation for your radio from the ProSoft Technology website (www.prosoft-technology.com). If your computer does not have access to the Internet, you must download the software from the ProSoft Technology website to removable media, and then copy it to your computer.

1.3.2 General Features

The RadioLinx 802.11 Industrial Hotspots are high-speed wireless Ethernet radios with Power over Ethernet (PoE) and Serial Encapsulation. All radios operate at speeds up to 54 Mbps, and the RLX2-IHNF operates at speeds up to 300 Mbps. Designed for industrial installations, the RLX2-IHx series offers many features including hazardous location certifications, Bridging, IGMP Snooping, OFDM for noise immunity, repeater mode to extend range, QoS, VLANs, RADIUS Server support, automatic parent selection for self-healing, OPC server diagnostics, extended temperature, high vibration/shock and DIN-rail mounting. For individual radio product specifications and agency approvals, see *Appendix J - Detailed Radio Specifications* (page 230). For descriptions of the LEDs, see *LED Display* (page 178).



1.3.3 Antenna Port Connections

This section only addresses physical antenna connections. Actual antenna selection and configuration is discussed in other chapters in this manual. You must install antennas in accordance with Control Drawing 06/2514. See *Appendix G - Antenna Configuration* (page 215) for further details.

Each radio must have an antenna connected to the Main antenna port on the RLX2-IHA/G/W radio models. The RLX2-IHNF radio supports up to three antennas, configurable on the *Advanced Settings* page. Match the #antennas control (Port A, Port A – Port C, or Port A – Port B – Port C) to the number of antennas that are in use. Antennas must be connected to the radio when in use on the network.

Mount all antennas that are directly connected to the radio so that polarization is the same. You can mount antennas with an N-jack connector directly to the radio using an N-plug to SMA-RP-plug adapter. Screw the antenna onto the antenna port connector until snug.

For remote placement of antennas, you may use an extension cable with N-plugs. Because the antenna cable attenuates the RF signal, use an antenna cable length that is only as long as necessary to ensure optimum performance.

Important: If the radio is to be used in a hazardous location, you must mount the radio in an enclosure approved for hazardous locations.

Each RLX2-IHx series radio has active antenna connectors on the top as shown below:

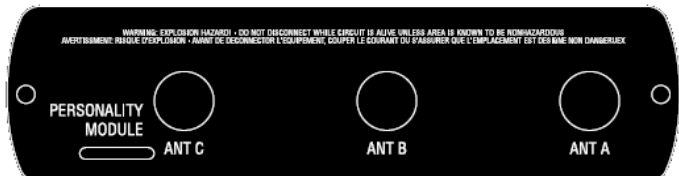
<p>RLX2-IHA RLX2-IHG</p> <ul style="list-style-type: none"> Single Antenna Port 	
<p>RLX2-IHNF</p> <ul style="list-style-type: none"> 3 Active Antenna Ports Allows MIMO operation 	

RLX2-IHNF-W

- 3 Active Antenna Ports
- Allows MIMO operation
- Weatherproof
- Hazardous Location
- Class I, DIV2 compliant



RLX2-IHNF-WC

- 3 active antenna ports
- MIMO operation
- Hazardous location
- Conduit version
- Class I, DIV 2 compliant



RLX2-IHW

- Right antenna port for transmit and receive
- Left antenna port for receive diversity to improve performance in some applications



1.4 Package Contents

1.4.1 RLX2-IHA, -IHG, -IHNF, -IHW

The following components are included with standard RLX2-IHx series radio products:

Qty.	Part Name	Part Number	Part Description
1	RLX2-IHx series Radio	<i>Varies</i>	Radiolinx® RLX2-IHx series 802.11 Industrial Hotspot
1	Personality Module	SDI-1G	Industrial Grade microSD card (blank)
1	Power Connector	002-0116	Mating power connector for the RLX2-IHx series radios, for attachment to customer's power supply.
1	Power Connector Wiring Tool	357-0061	Tool to assist wiring the power connector.
1	Antenna	A2502S-OA	2 dBi Omni RP-SMA articulating, 2.4/5GHz. This antenna is suitable for all RLX2-IHx series radio products.

You can download sample programs, utilities, firmware images, and documentation for your radio from the ProSoft Technology website (www.prosoft-technology.com). If your computer does not have access to the Internet, you must download the software from the ProSoft Technology website to removable media, and then copy it to your computer.

1.4.2 RLX2-IHNF-W

The following components are included with Weatherproof RLX2-IHx series radio products:

Qty.	Part Name	Part Number	Part Description
1	RLX2-IHx series Radio	RLX2-IHNF-W	Radiolinx® RLX2-IHx series 802.11 Industrial Hotspot Weatherproof
2	U-mounting brackets		Pole mounting brackets
1	IP67 M12 Cap		Water tight cap

You can download sample programs, utilities, firmware images, and documentation for your radio from the ProSoft Technology website (www.prosoft-technology.com). If your computer does not have access to the Internet, you must download the software from the ProSoft Technology website to removable media, and then copy it to your computer.

1.4.2.1 RLX2-IHNF-W Cables (sold separately)

The following cables are for outdoor locations:

Part Name	Part Number	Part Description
Locking Clip	CUL-M12-LOCKCLIP	
7 foot (2m), M12 to RJ45, Network Cable/ PoE or 33 foot (10m), M12 to RJ45, Network Cable/PoE	CULRJ45-M12-007 CULRJ45-M12-033	7 foot Network PoE cable 33 foot Network PoE cable
33 foot (10m), M12 to unterminated leads, Power Cable or 10 foot (3m), M12 to unterminated leads, Power Cable	CULPWR-M12-033 CULPWR-M12-010	33 foot Power Cable 10 foot Power Cable

1.4.3 RLX2-IHNF-WC

The following components are included with Weatherproof Hazardous Location RLX2-IHx series radio products:

Qty.	Part Name	Part Number	Part Description
1	RLX2-IHx series Radio	RLX2-IHNF-WC	Radiolinx® RLX2-IHx series 802.11 Industrial Hotspot
1	5 foot CAT 6 Ethernet PoE cable		Preinstalled 6 foot CAT 6 Ethernet PoE cable
1	5 foot flying leads power cable		Preinstalled 6 foot flying leads power cable
2	U bolts for mounting		Pole mounting brackets

You can download sample programs, utilities, firmware images, and documentation for your radio from the ProSoft Technology website (www.prosoft-technology.com). If your computer does not have access to the Internet, you must download the software from the ProSoft Technology website to removable media, and then copy it to your computer.

1.4.4 Industrial Hotspot Bench Test Kit (RLX-IHBTK)

The standard radio products are intended for use with production systems and do not include accessory power supplies or cables. For bench testing of radios, an optional bench test kit provides these accessories:

Qty.	Part Name	Part Number	Part Description
1	Power Supply	RL-PS007-2	AC Power Adapter, 12V1.6A w/2 pin & 4 plug Set
1	Cable	RL-CBL025	5 foot Ethernet Straight-Thru Cable
1	Cable	085-1007	6 foot RS232 serial cable
1	Adapter	HRDNULL-DB9	RS232 null modem serial adapter

1.5 Installing the RadioLinx Industrial Hotspot Browser

Use the *RadioLinx Industrial Hotspot Browser Configuration Tool* (hereafter called the *IH Browser*) to set up and configure the RLX2-IHx series radios. It is designed for personal computers running the Microsoft Windows operating systems.

1.5.1 IH Browser System Requirements

The IH browser is designed to run on Microsoft Windows, and is supported on the following versions:

- Microsoft Windows 7 Professional 32- or 64-bit, with Service Pack 1
- Microsoft Windows 10

Other Microsoft Windows operating system versions may work but have not been tested by ProSoft Technology and are not officially supported.

In addition, these items may be needed:

- An RS-232 port on the PC or a USB-to-serial convertor cable, to use serial encapsulation features or to access system debugging information.
- An internet connection to download updated product information from the ProSoft Technology website at www.prosoft-technology.com.

1.5.2 Installing IH Browser Software

You must install the *RadioLinx Industrial Hotspot Browser* (IH Browser) software to configure the radio as the RLX2 is not shipped with a default static IP Address.

To install IH Browser from the ProSoft Technology website

- 1 Open your web browser and navigate to www.prosoft-technology.com.
- 2 Use the search box on the ProSoft Technology page to search for *IH Browser* and then click the link for the *RadioLinx IH Browser*.
- 3 Click the *Download* tab and then click *RadioLinx IH Browser* to download the latest version of the IH Browser.
- 4 Choose **SAVE** or **SAVE FILE** when prompted.
- 5 Save the file to your *Windows Desktop*, so that you can find it easily when you have finished downloading.
- 6 When the download is complete, locate and double-click the zip file. This extracts the installation file (RadioLinx IH Browser 3.130.msi or a newer version).
- 7 Double-click the **.msi** file to install the IH Browser.

If your computer does not have access to the Internet, you must download the software from the ProSoft Technology website to removable media, and then copy it to your computer.

1.5.3 Starting the IH Browser

To start the *RadioLinx Industrial Hotspot Browser* (IH Browser), click **START > ALL PROGRAMS > PROSOFT > IH BROWSER**. If the software is not installed, see *Installing IH Browser Software* (page 22). For more information on the IH Browser and its functions, see *Using the IH Browser to Manage your Radios* (page 121).

2 Network Planning

It may be helpful to create a network plan before configuring and installing your RLX2-IHx series radio wireless network. This topic assumes a bridge network of Master and Repeater radios. Client radios can also be configured to work with devices on existing wireless LANs. For more information, see *Configuring a Client Radio* (page 50).

The simplest way to design the physical network of radios, antennas, connectors, cables, amplifiers and other accessories is to use the *ProSoft Wireless Designer*. This is a free software application that determines the hardware needs based on your answers to a few questions.

The *ProSoft Wireless Designer* generates a *Bill of Materials* specifying all the components you need for the installation. *ProSoft Wireless Designer* is included on the ProSoft Technology media supplied with the RLX2-IHx series radio, and is also available by downloading it from the ProSoft Technology website. See *Installing the ProSoft Wireless Designer* (page 24).

- 1 To begin, identify the potential radio locations. For example, the you may install the Master radio near a PC in a central plant location. You can then use this PC to locate and configure the radios through the IH Browser. If the plant is an oil refinery, for example, you may need to install radios installed near the oil tanks.
- 2 The next important issue is how to link the radios. Unless the radios are very close together, make sure that each pair of radio antennas in the network has a clear line of sight between them. In other words, you must be able to see from one antenna to another, either with your eyes or with binoculars.
- 3 If there is no line of sight between antennas, you must locate an additional site for a Repeater radio. The Repeater radio creates a bridge between the radio antennas.
- 4 Choose the appropriate antennas for the network. You may need a power amplifier (available from ProSoft Technology) if an antenna is connected to the radio by a long cable. Signal loss at the radio is proportional to the distance between an antenna and its radio (longer cable, more signal loss). *ProSoft Wireless Designer* can suggest suitable antennas for the application based on frequency band, data rate, distance, power output level, etc.
- 5 Consider drawing the network plan on paper. Assign a logical name to each radio in your plan. You can then assign these names to the Radios during configuration.
- 6 A site survey may be helpful. You can hire ProSoft Technology or a surveyor to perform a survey, or you can conduct the survey on your own.
- 7 Plan to protect radios from direct exposure to weather, and provide an adequate, stable power supply. Make sure the plan complies with the radio's power requirements and cable specifications.

Important: Radios and antennas must be located at least 8 inches (20 cm) away from personnel.

2.1 Installing the ProSoft Wireless Designer

You can install the *ProSoft Wireless Designer* software to help you design your RLX2-IHx series radio network. You can always get the newest version of ProSoft Wireless Designer from the ProSoft Technology website (www.prosoft-technology.com).

To install ProSoft Wireless Designer from the ProSoft Technology website

- 1 Open your web browser and navigate to www.prosoft-technology.com.
- 2 Use the search box on the ProSoft Technology page to search for *ProSoft Wireless Designer* and then click the link for the *ProSoft Wireless Designer*.
- 3 Click the *Downloads* tab and then click *ProSoft Wireless Designer* to download the latest version of the software.
- 4 Choose **SAVE** or **SAVE FILE** when prompted.
- 5 Save the file to your *Windows Desktop*, so that you can find it easily when you have finished downloading.
- 6 When the download is complete, locate and double-click the zip file. This extracts the installation file (Installer.msi).
- 7 Double-click the **.msi** file to install the software.

You can download sample programs, utilities, firmware images, and documentation for your radio from the ProSoft Technology website (www.prosoft-technology.com). If your computer does not have access to the Internet, you must download the software from the ProSoft Technology website to removable media, and then copy it to your computer.

2.2 Installation Questions

The following questions will help in getting familiar with the system.

How many radios are in the network?	
Master ID:	
Repeater ID:	
Client ID:	
Locations:	
Is there a clear line of sight between them?	
What type of antennas will be used in the network?	
Will you use the Personality Module configuration restoration feature (MicroSD card)?	

2.3 Planning the Physical Installation

A network's performance is affected by attributes specific to the installation site. Consider the following cautions:

- Add Repeater radios to extend the distance to the next radio or where line of sight to the next radio is limited.
- Radios or antennas CANNOT be placed within 8 inches (20 cm) of personnel.

Though radio frequency communication is reliable, sometimes the performance can be affected by other factors. A good network installation plan includes both the time and the resources for testing the performance and modifying the installation.

Test the installation plan before the network installation is complete. See *Testing the Network Installation* (page 27).

2.4 ProSoft Wireless Designer

ProSoft Wireless Designer is a free software tool from ProSoft Technology that simplifies the task of creating a ProSoft wireless installation. The following image shows an example of a wireless radio network an estimate of signal quality between two radios.

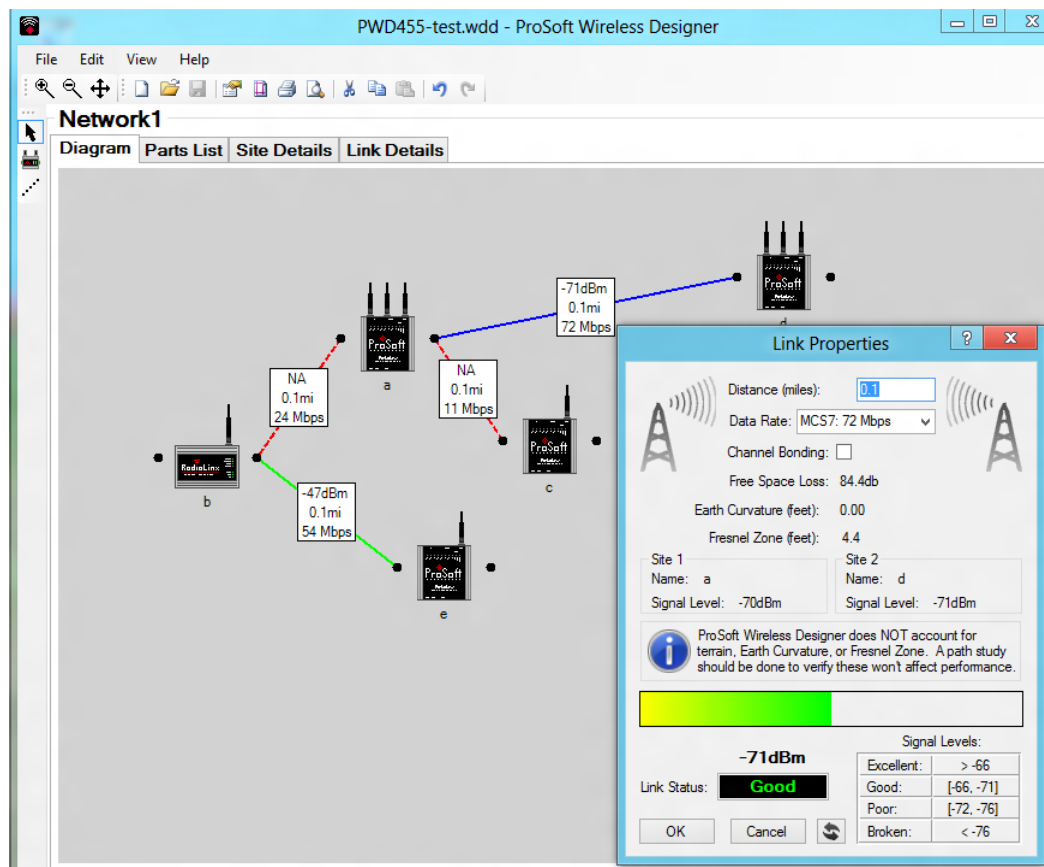

ProSoft Wireless Designer can also compute a Bill Of Materials (BOM) for a complete radio installation, including antennas, cables, connectors and other required materials.

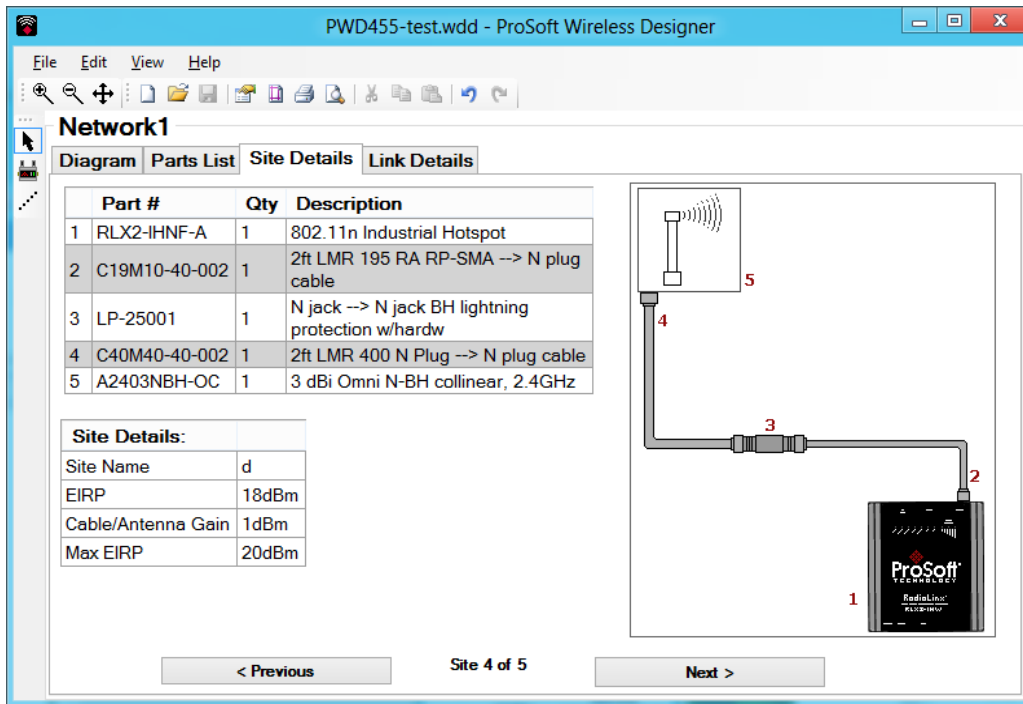

You can download the *ProSoft Wireless Designer* from the ProSoft Technology website. It provides a variety of views of your networks, along with an accurate description of each site in a wireless network. These include:

- Visual diagram of site layout
- Location (latitude/longitude, based on GPS coordinates)
- Radio type, frequency range, and country-specific channel and power requirements
- Length, type and estimated signal loss for cables
- Required accessories, including lightning protection, cable adaptors and antennas
- Complete parts list

ProSoft Technology technical personnel use *ProSoft Wireless Designer* if you request a site audit for customers, and then give you a complete list of components and a detailed description for each site and link. You can use this information to understand and visualize your wireless network, and have the necessary information for technical support and maintenance.

2.4.1 Designer Functional Specifications

ProSoft Wireless Designer includes the following features:

- It contains a database of all currently available RadioLinx radios, antennas, cables, connectors and accessories.
- It exports parts lists, site and link details, and setup Wizard settings into a variety of common file formats for import into applications such as spreadsheets, databases, and word processors.
- It checks wireless link feasibility based on path length and recommended accessories.
- It predicts signal strength based on distance, local regulations, and hardware choices.
- It fully documents the ProSoft Technology wireless network plan.

2.5 Testing the Network Installation

Use the following steps to test your wireless network before you permanently install the radios and antennas.

Note: If you are using the Personality Module feature (MicroSD card), remove the MicroSD card from its packaging and insert it into the Personality Module slot in each radio before you configure the radio. After you save the RLX2 configuration from the radio's web interface (or write it to the card by clicking **WRITE SD CARD** on the **ADVANCED SETTINGS** tab), you can leave the MicroSD card in the radio, or store it in some other location. It is important that you keep the MicroSD card in a secure location in case it is needed when you replace a radio.

- 1 Configure all the radios in the network. See *Using the IH Browser to Configure Radios* (page 37). If possible, configure all the radios side by side in an office setting and make sure they link before installing them in the field. If feasible, test with the radios and end-device equipment together before they are installed in the field.

Tip: To make it easier to physically identify the radios, apply a label to each radio indicating the radio name and IP address.

- 2 Install the Master radio in its proposed permanent location.
- 3 Connect the PC with the IH Browser software to the Master radio. See *Making Power and Data Connections* (page 31).
- 4 Install the other radios (Repeater, Client, and Bridging Client) in their proposed locations.
- 5 Temporarily place each radio's antenna near its proposed mounting location. The antenna can be held in place by hand. However, one person must hold the antenna while the other person monitors the Remote radio's signal strength in the IH Browser on the PC.

- To see how a radio is linked in the network, make sure that the Master radio is connected to the PC. Then, in the IH Browser, from the **VIEW** menu click **TOPOLOGY VIEW**.

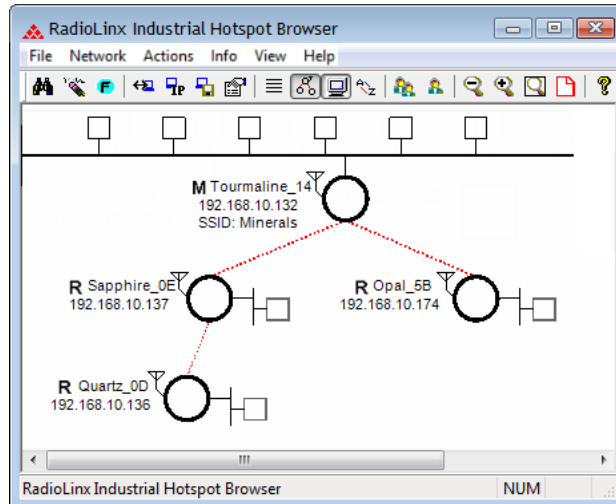

- The Topology view shows a diagram of the network's wireless connections. Use this view to see whether all the radios are linked, and verify that the radios are linked correctly.
 - A radio that is not linked to a parent appears as a circle outlined by a flashing dashed red line. It may be near the bottom of the window. Scroll down to view all available radios.
 - See *Improving Signal Quality* (page 28) for more information on overcoming poor signal strength between radios.

2.5.1 Improving Signal Quality

To improve the signal quality of each Remote radio, try the following.

- Increase the height of the antenna's placement
- Use higher-gain antennas
- Decrease any TX attenuation that has been configured in the radios
- Select a new location for the Remote radio and/or its antenna
- Decrease the length of antenna cable
- Determine and resolve sources of electrical noise which may be interfering with the radio transmission
- Add a Repeater radio between the radios that are not communicating, or reconfigure an existing radio as a Repeater if line of sight is available

2.6 Detecting 802.11 Access Points

You can use your RLX2-IHx series radio as an installation tool to analyze the 802.11 environment and provide information on choosing antenna location and channel selection.

- 1 Install the radio with its correct antenna.
- 2 Configure the radio as a Repeater radio with a Test SSID so it continuously scans.
- 3 Start the IH Browser. See *Starting the IH Browser* (page 22).
- 4 In the IH Browser, select the radio, and then from the **INFO** menu choose **SCAN LIST**. See *Using the IH Browser to Manage your Radios* (page 121).

The *Scan List* dialog box displays information all active 802.11 radios in the area, including:

- Each 802.11 Access Point detected, including the AP's SSID
- The actual RSSI (signal strength) from each AP in dBm
- The channel of each radio detected

Use this information to help choose a channel that has the lowest utilization, or to select appropriate antenna types and alignments to minimize interference.

3 RLX2-IHx Series Quick Setup

This chapter describes how to set up RLX2-IHx series radios in a minimal configuration before deploying them in the permanent installation. The procedures in this section help familiarize you with basic configuration procedures, and show you how to verify that the radios are operational.

Note: If you have not designed your wireless network, see *Network Planning* (page 23) for the steps to design your network using the *ProSoft Wireless Designer*. In addition to helping you design your network, *Prosoft Wireless Designer* also creates a Bill of Materials listing all the components for the network.

The procedures described in this section assume the radios are in their default configurations as shipped by ProSoft. If that is not the case, you can reset the radios to factory defaults before attempting these procedures. See *Resetting a RLX2-IHx Series Radio* (page 180).

Note that in any given network, there must be at least one RLX2-IHx series radio acting as a *Master*. Other radios that you configure as *Repeaters* or *Clients* will connect wirelessly to the Master to form a network bridge between their Ethernet interfaces.

If you are replacing an existing radio with a new radio of the same type, you can easily transfer the radio configuration from the old radio to the replacement radio. See *Replacing an Existing Radio* (page 53).

Important: If you do not have a ProSoft Technology Power adapter RL-PS007-2 (supplied with the RLX-IHBTK Bench Test Kit), see *Making Power and Data Connections* (page 31) for instructions on wiring the power connector.

3.1 Preparing the Configuration Environment

If you have all the RLX2-IHx series radios on your workbench, you may not need antennas for this procedure. Radios without antennas may have sufficient signal strength to link over short distances, without radiating or receiving unnecessary surrounding RF energy. However, we recommend that you connect an antenna to the Master radio. See *Antenna Port Connections* (page 17).

Important: If the radios are close enough to each other that their received signal strength is greater than -40 dBm, performance may be degraded. Disconnect antennas from radios during bench testing, or move the radios further apart from each other.

Tip: To make it easier to physically identify the radios, apply a label to each radio indicating the radio name and IP address.

3.2 Making Power and Data Connections

3.2.1 RLX2-IHW, IHNF, IHG, IHA Radio Connections

The power, Ethernet, and serial (RS-232) connections for these radios are located on the bottom of the case.



- 1 Attach an Ethernet cable to the radio you want to be the Master RLX2-IHx series radio. If you are connecting to a network, make sure this network connection is on the same subnet as the PC running the IH Browser configuration software.
- 2 Connect a power cable (power connection included with the radio) to the 10-24 VDC port.
 - The Ethernet DATA LED illuminates when data is sent to or received from the radio.
 - The Ethernet SPEED LED indicates the speed of the Ethernet connection:

Ethernet Connection speed	SPEED LED
10 Base T	○ LED is off
100 Base T	● LED is on
1000 Base T	▮ LED blinks about once every two seconds

3.2.2 RLX2-IHNF-W Radio Connections

All power and Ethernet connections for these radios are located on the bottom of the case.



- 1 Attach an Ethernet cable with an M12 connector to the radio you want to be the Master radio. If you are connecting to a network, make sure this network connection is on the same subnet as the PC running the IH Browser configuration software.

Note: The RLX2-IHNF-W Weatherproof radio uses M12 connectors for both Ethernet and power. You can order these cables directly from ProSoft Technology.

- 2 Connect the power cable with an M12 connector to the specified port shown.

Note: The RLX2-IHNF-W radio can be powered over Ethernet (POE) with an approved injector available from ProSoft. In this case, the Power connector would not be used.

- 3 If PoE is used, cap the Power Connector with the M12 Waterproof Cap.
- 4 Connect the Ethernet cable through the PoE injector (if using PoE) and into the network switch.

Note: Most off-the-shelf PoE Injectors work with this unit except the 802.3at/ PoE+ Injectors.

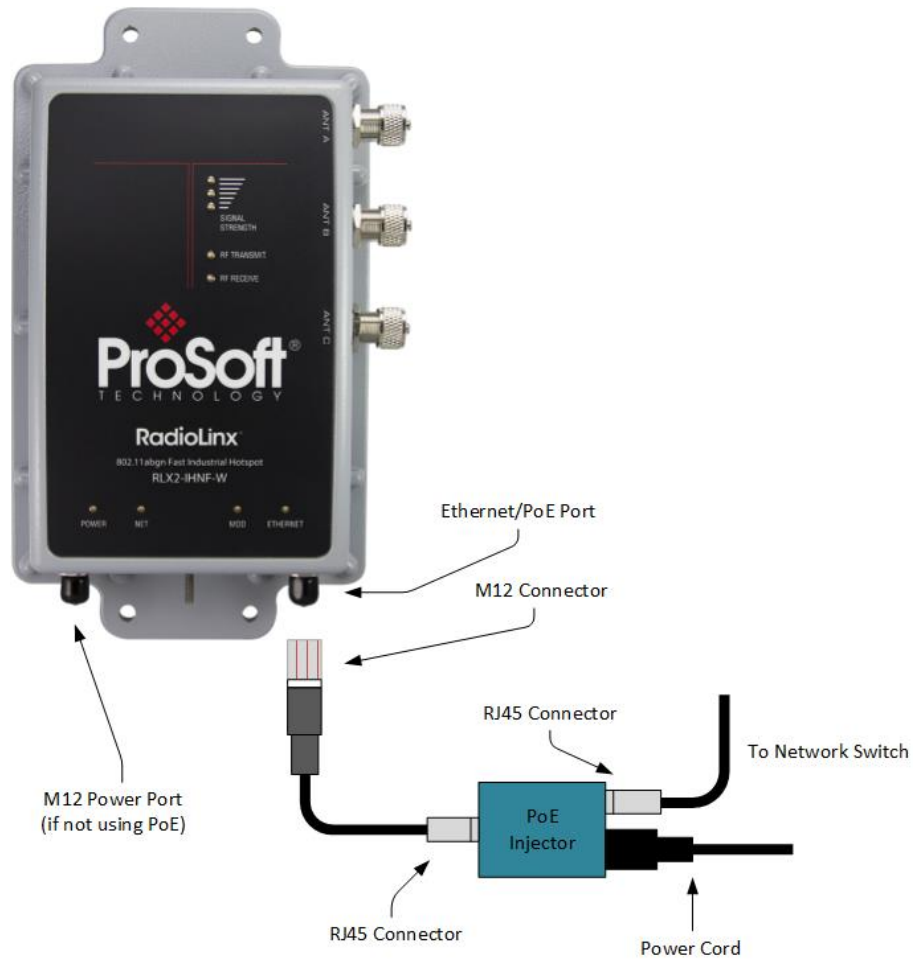

Note: The M12 PoE cable is not included with the radio but can be ordered through ProSoft.

Warning: Do not connect or disconnect the M12 Power Port or PoE connection when energized, that is, the cable is live.

3.2.3 RLX2-IHNF-WC Radio Connections

This radio is suitable for Class I, DIV2 hazardous locations. The power and Ethernet connections for these radios are a set of wires that protrude through a single conduit hub located on the bottom of the case.

- One wire is terminated with an RJ45 connector for Ethernet connections. This wire can also supply power when attached to a PoE Injector.
- The second wire supplies power to the radio if not attached to a PoE Injector. If you are using PoE, make sure you insulate this wire from the other wires to prevent shorting.

To install this radio

- 1 Place a seal cap over the top of the conduit as shown below.
- 2 Run both wires down through the conduit.
- 3 Push the conduit up into the permanently installed connector on the bottom of the radio. Push it up as far as it will go.



Warning: The recommend conduit is Thomas & Betts® PMA Series, Cat. No. CYLT-23B.

- 4 Place the oval clip into the opening in the connector until it snaps into place. This secures the conduit to the connector.

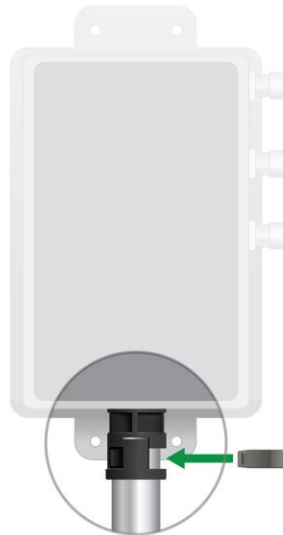

Note: In the event that you have to remove the conduit, simply remove the oval clip by using a screwdriver to pry it out. You can then remove the conduit from the connector.



The wire with the RJ45 connector is your Ethernet connection and supports Power over Ethernet (PoE).

Warning: Do not connect or disconnect the PoE connection when energized.

5 If you are not using PoE, use the other wire set to power the radio.

Note: If you are using PoE to provide power to the radio, insulate the additional power cable from other wires inside the junction box during installation to prevent the wire assembly from shorting out.

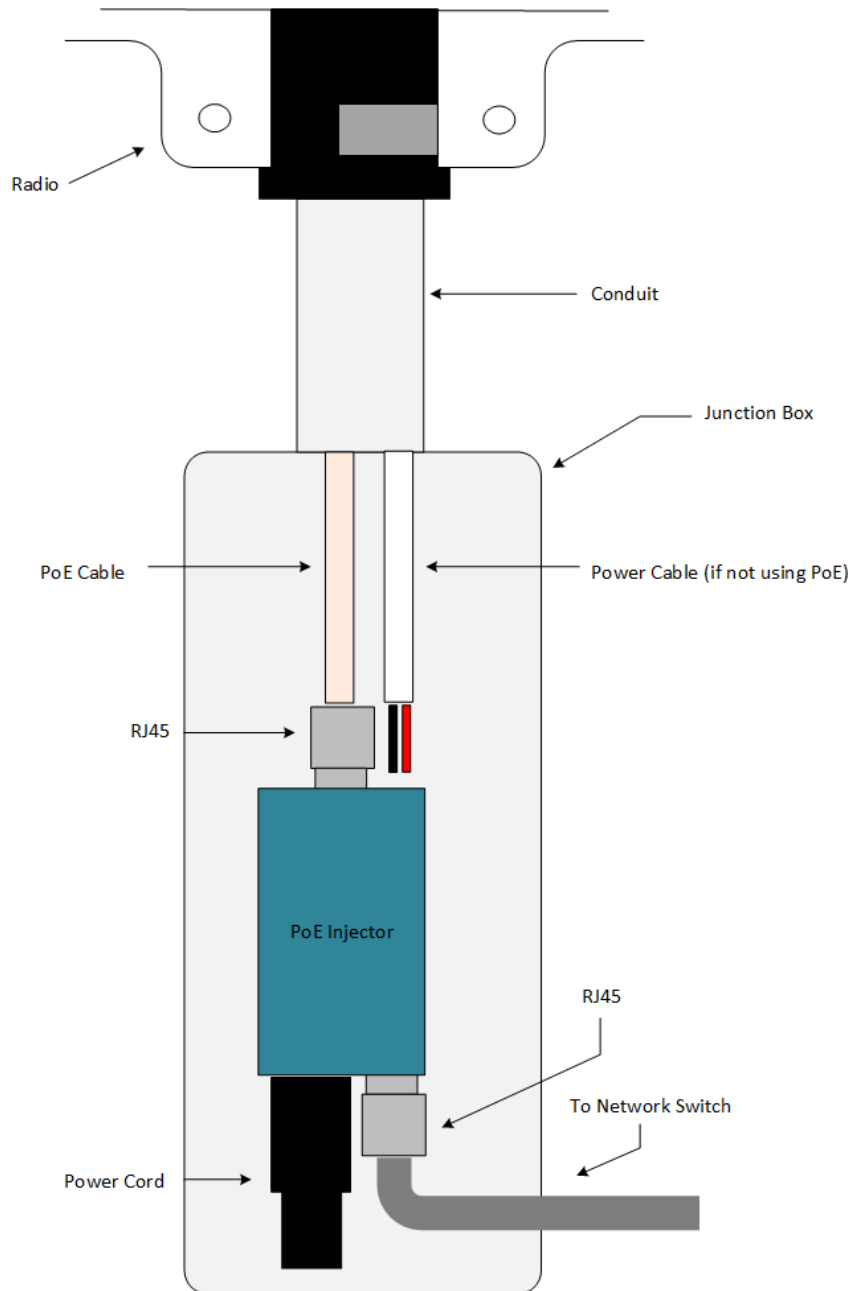

3.3 Radio Power-Up

RLX2-IHx series radios power-up when power is supplied to the radio—there is no On/Off switch. The Power LED cycles when power is applied. First the Power LED lights AMBER when power is applied, then the LED goes out for a few seconds during initialization, and then lights GREEN. This process takes 10 to 15 seconds. Once the Power LED is green, the radio is booted and operational. Other LEDs on the radio may become active as well.

Please note the MAC address of the RLX2-IHx series radio, printed on a label attached to the front of the radio. The MAC address has the form 00-0D-8D-XX-YY-ZZ. For example, 00-0D-8D-F0-5C-8E. This number uniquely identifies the radio on the network. You use this number to identify the radio on the network when using the IH Browser.

3.4 Using the IH Browser to Configure Radios

This section describes how to use the *RadioLinx Industrial Hotspot Browser* (IH Browser) to set up RLX2-IHx series radios in a minimal configuration before deploying them in the permanent installation. See *Using the IH Browser to Manage your Radios* (page 121) for detailed descriptions of all the features available in the IH Browser.

3.4.1 Viewing the Radios in the IH Browser

Start the IH Browser: see *Starting the IH Browser* (page 22). If the radio is powered up and connected, it appears in the IH Browser. Note that the *MAC* address is the same address as that of the label on the radio. The *List* view (shown in the image below) displays the RLX2-IHx series radios (or previous generation RLXIB radios, except the RLXIB-IHN) on the same network as the computer running the IH Browser.

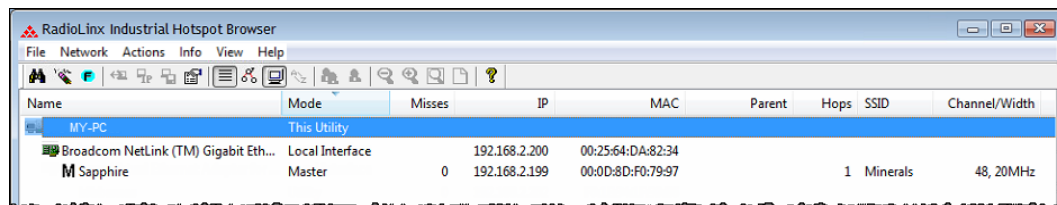



Note: You can perform many common tasks by right-clicking on the radio and choosing a command.

3.4.2 Refreshing the Display in the IH Browser

To refresh the display

If you have made changes to a radio's configuration, refresh the IH Browser by clearing and scanning the display using the buttons on the toolbar.

-  The *Erase* button clears the radios from display (or from the **FILE** menu choose **CLEAR**).
-  The *Scan* button rescans the network for RLX2-IHx series radios (or from the **FILE** menu choose **SCAN**).

3.4.3 Setting the Radio IP Address in the IH Browser

To set the radio IP address

- If the radio is on a network with a DHCP server, it gets an IP address through DHCP.
- If the radio is not on a network with a DHCP server, the radio appears with an IP address of 0.0.0.0. You can assign a temporary IP address to assist with configuring the radio. See *Assigning a Temporary IP Address* (page 39).

3.4.4 Assigning a Temporary IP Address

A temporary IP address allows you to access and configure a radio when the radio either does not have an IP Address or it has an IP Address that is on a network subnet different than the PC running the IH Browser.

- 1 In the IH Browser, right-click the radio and then click **ASSIGN IP**.

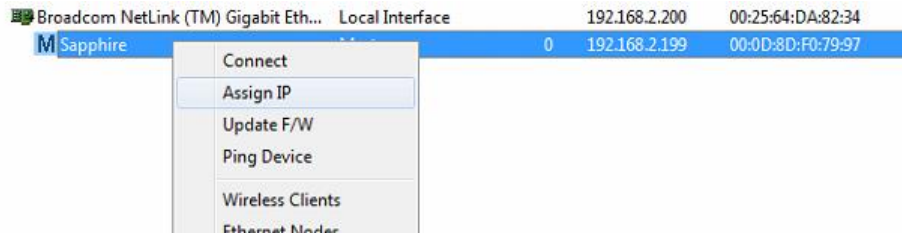

This opens the *Assign Temporary IP Address* dialog box.

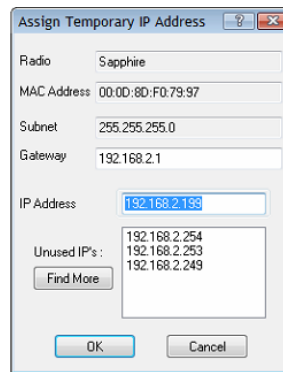

The **UNUSED IP'S** list are the IP addresses that are currently available on the network.

- 2 The IH Browser suggests the network parameters for the temporary IP address. It queries the IP addresses and displays them if it does not receive a response. Click one of the unused IP's, or enter an unused IP address, and then click **OK**. The IH Browser warns that the IP address is temporary.

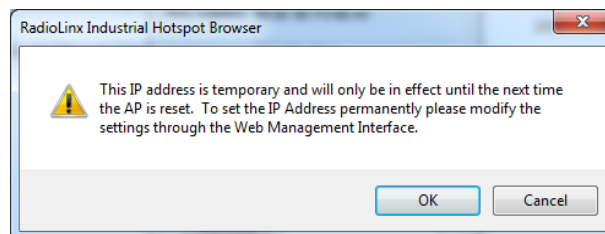

- 3 Click **OK** and then refresh the display in the IH Browser. Your radio should now appear in the IH Browser window with the temporary IP address.
- 4 To set a permanent IP address for the radio, see *Configuring a Radio - Getting Started* (page 40).

3.5 Configuring a Radio - Getting Started

This section describes how to set up RLX2-IHx series radios in a minimal configuration before deploying them in the permanent installation. See *Configuring a Radio - Detailed Configuration* (page 54) for a detailed description of all the configuration parameters available for your radio.

3.5.1 Connecting to the Radio Configuration Interface

This section describes how to connect to the RLX2 *Radio Configuration / Diagnostic* web interface using a web browser such as Internet Explorer or Firefox on your PC or other network-enabled device.

To connect to the Radio Configuration / Diagnostic web interface

Important: Your computer or other device must be connected to the same network as the RLX2-IHx series radio.

- 1 Log into the web interface of the radio. You can do this in any of three ways:
 - In the IH Browser List view or Topography view, right-click the radio and then click **CONNECT**.
 - In the IH Browser List view or Topography view, double-click the radio.
 - Open a web browser on your PC, and then in the address bar, type `http://`, followed by the IP address for the radio, and then press **ENTER**. For example, `http://192.168.6.10`.

The login screen appears in the web browser.

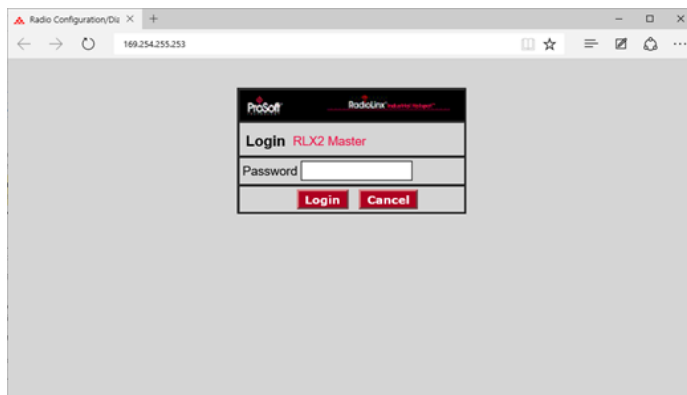

- 2 Enter the password and then click **LOGIN**. The default password is *password*. If you have lost the password for the radio, you can reset the radio to its default settings. See *Resetting a RLX2-IHx series Radio* (page 180).

If the radio is set to its factory settings or has been reset to defaults, then the first page that opens requires a new password be set before the configuration tabs are enabled. This is to ensure that the radio isn't unintentionally put into operation using the factory default password.

Type the default password into the **OLD PASSWORD** edit box, then a password with sufficient security strength into the **NEW PASSWORD** edit box.

As you type in the **NEW PASSWORD** the security strength is indicated to the right of the edit box and in its background color.

The password entered is measured against 4 categories. Each of the categories must be satisfied in order to achieve a “strong” password strength.

- Must contain both lower and upper case letters
- Must contain one or more numbers
- Must contain at least one non-alphanumeric character (e.g. !@#%).
- Must be at least 8 characters in length.

In addition if the default password is embedded in the New Password then those characters are ignored when testing for each of the above criteria.

After entering the New Password the password is entered once again in the **REPEAT PASSWORD** edit box to mitigate any typing errors.

Clicking the **DONE** button opens the main configuration webpage of the radio.

Note: Some parameters may be different from the image depending on your specific radio model.

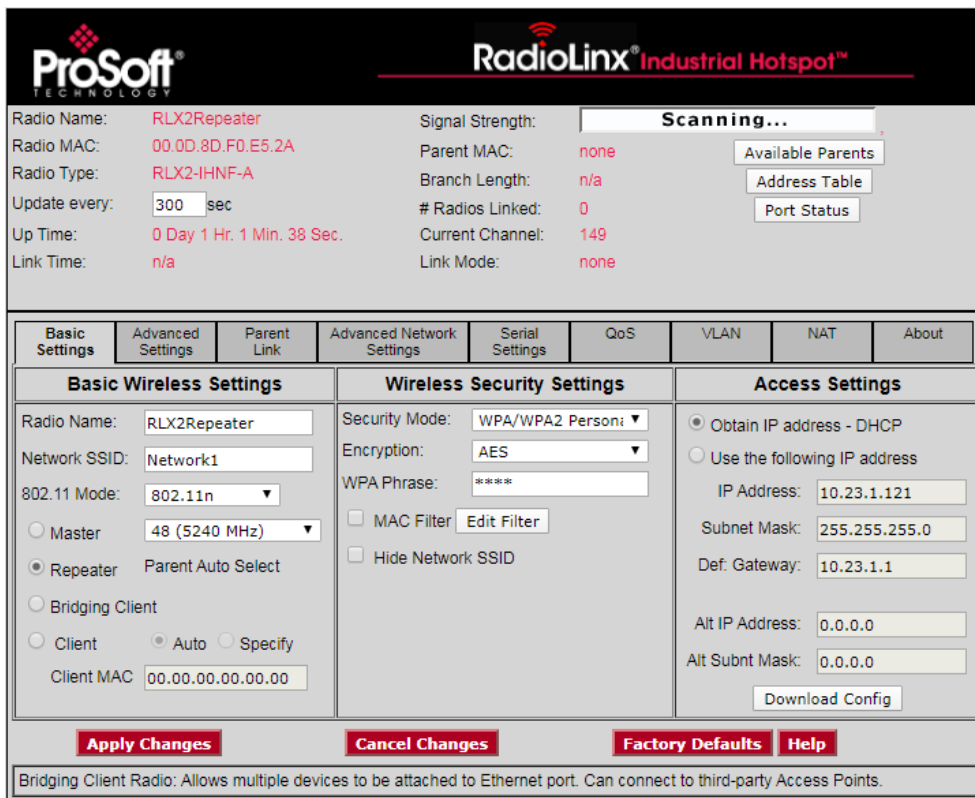

Tip: You can display the help topic for any parameter in the RLX2 webpage by clicking the parameter name. The parameter name turns blue when you move the cursor over a parameter with a help topic. There is also a short description at the bottom of the window.

3.5.2 Configuring a Master Radio

Most wireless networks consist of one *Master radio* and multiple *Repeater radios*. All RLX2-IHx series radios are shipped pre-configured as Repeaters by default. Your first task in setting up a new network is to configure one radio as the network Master. This section describes how to configure basic settings for a Master radio.

To configure a Master radio

- 1 Start the IH Browser.
- 2 Launch a Web Browser to the radio's web interface and Log In. See *Connecting to the Radio Configuration Web Interface* (page 40).
- 3 On the **BASIC SETTINGS** tab, in the **BASIC WIRELESS SETTINGS** group, click the **MASTER** radio button and then select a channel (Example: **Channel 48**).

The screenshot shows the RadioLinX Industrial Hotspot web interface. At the top, it displays the ProSoft Technology logo and the RadioLinX Industrial Hotspot title. Below this, there are several status fields: Radio Name (RLX2 Master 1), Radio MAC (00.0D.8D.F0.E5.2A), Radio Type (RLX2-IHNF-A), Update every (15 sec), Up Time (0 Day 0 Hr. 21 Min. 28 Sec.), Link Time (n/a), Signal Strength (Master), Parent MAC (none), Branch Length (1), # Radios Linked (1), Current Channel (48), and Link Mode (802.11n 20MHz channel). There are buttons for 'Available Parents', 'Address Table', and 'Port Status'.

The main configuration area is divided into three tabs: Basic Settings, Advanced Settings, and Parent Link. The Basic Settings tab is active and contains three sub-sections: Basic Wireless Settings, Wireless Security Settings, and Access Settings.

- Basic Wireless Settings:** Radio Name (RLX2 Master 1), Network SSID (Network11), 802.11 Mode (802.11n), and a dropdown menu for the radio mode. The 'Master 48 (5240 MHz)' option is selected and highlighted with a red box. Other options include Repeater, Bridging Client, and Client (Auto/Specify). Client MAC is 00.00.00.00.00.00.
- Wireless Security Settings:** Security Mode (WPA/WPA2 Personal), Encryption (AES), WPA Phrase (****), and checkboxes for MAC Filter, Hide Network SSID, and Edit Filter.
- Access Settings:** Radio buttons for 'Obtain IP address - DHCP' and 'Use the following IP address'. Fields for IP Address (10.23.1.114), Subnet Mask (255.255.255.0), Def. Gateway (10.23.1.1), Alt IP Address (0.0.0.0), and Alt Subnet Mask (0.0.0.0). A 'Download Config' button is at the bottom.

At the bottom of the configuration area, there are buttons for 'Apply Changes', 'Cancel Changes', 'Factory Defaults', and 'Help'. A footer note states: 'Radio Name: 1 to 31 characters. For user's identification of radio only.'

Note: To communicate with each other, all RLX2-IHx series radios must communicate over the same frequency in either the 2.4 GHz or the 5 GHz frequency band. The available frequency bands depend on the type of radio.
The RLX2-IHA uses 5 GHz frequency band only.
The RLX2-IHG uses 2.4 GHz frequency band only.
The rest of the RLX2-IHx series radios can use both 2.4 and 5 GHz.

- 4 Edit the **RADIO NAME** if desired.

- If you set a temporary IP address in the radio (see *Assigning a Temporary IP Address* (page 39)), set the permanent IP address. On the **BASIC SETTINGS** tab, in the **ACCESS SETTINGS** group, click **OBTAIN IP ADDRESS - DHCP** or **USE THE FOLLOWING IP ADDRESS**.

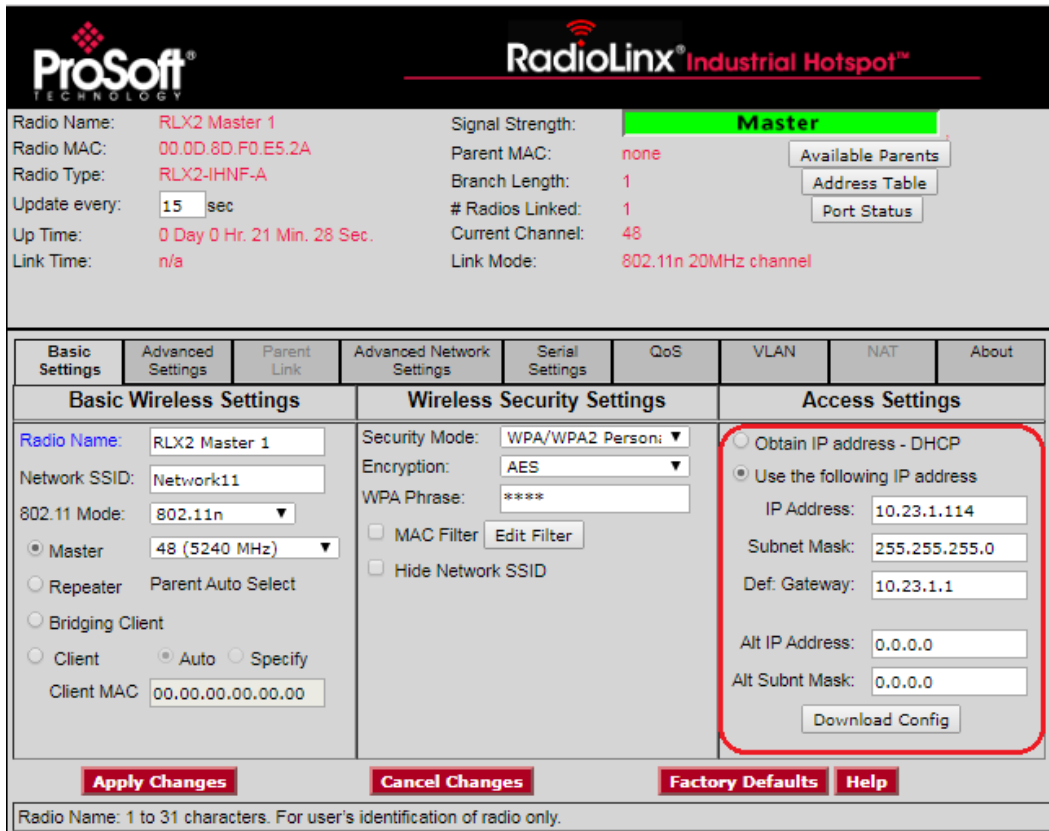

- Click **APPLY CHANGES** to reboot the Radio. The IH Browser displays a progress bar while the radio is rebooting.

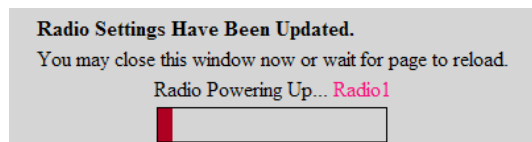

- After the radio reboots successfully, refresh the display in the IH Browser. See *Refreshing the Display in the IH Browser* (page 38). The radio appears as a Master in the IH Browser window:

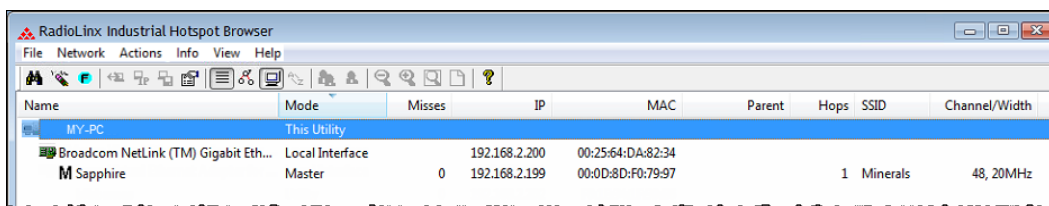

3.5.3 Configuring a Repeater Radio

After you configure one radio as the Master radio, any powered RLX2-IHx series radios in their default shipping configuration should automatically link to the Master radio. You do not need to attach an Ethernet cable to the additional radios.

To configure a Repeater radio

- 1 Start the IH Browser. After the radio starts, it should appear in the IH Browser.

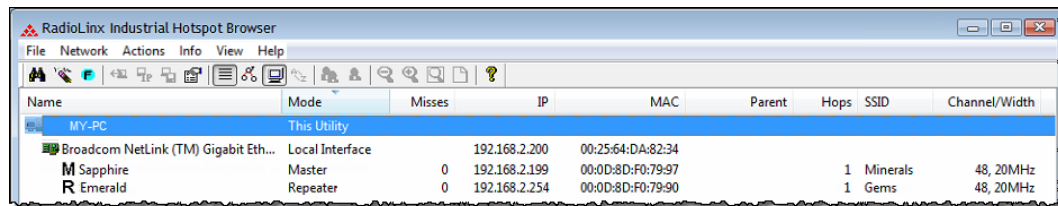

Note that the Repeater radio above (whose MAC address ends in 54 in the above example) has linked to the Master radio (whose MAC address ends in 97).

- 2 Log into the radio's web interface. See *Connecting to the Radio Configuration Interface* (page 40).
- 3 If the radio IP address is 0.0.0.0, assign a temporary IP address to the Repeater radio. See *Assigning a Temporary IP Address* (page 39). In this example, the Repeater has an IP address of 192.168.2.254.
- 4 On your PC, open a command prompt window and use the Ping command to ping the Repeater radio's IP address. The Master radio should ping the Repeater radio so that you see the following.

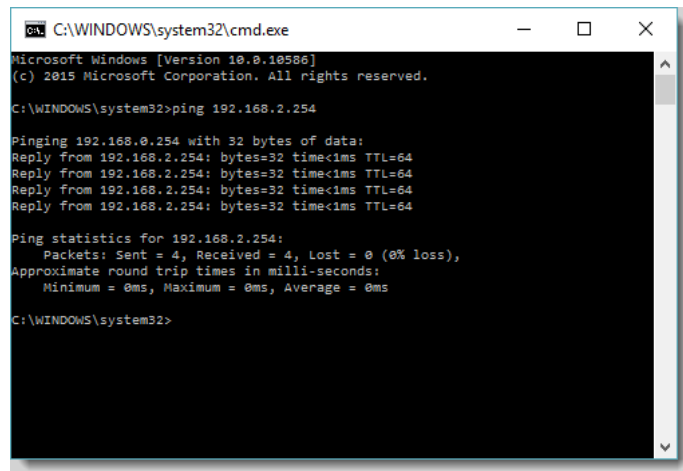

- 5 If this is successful, then you have successfully configured the RLX2-IHx series wireless network.

You can add additional Repeater radios by repeating these steps. If you want to make more changes to the radio's configuration, you can use the following steps.

- 1 Log into the radio.
- 2 Edit the **RADIO NAME** if desired.

Note: To communicate with each other, all RLX2-IHx series radios must communicate over the same frequency as the Master radio.

- 3 If you set a temporary IP address in the radio (see *Assigning a Temporary IP Address* (page 39)), set the permanent IP address. On the **BASIC SETTINGS** tab, in the **ACCESS SETTINGS** group, click **OBTAIN IP ADDRESS - DHCP** or **USE THE FOLLOWING IP ADDRESS**.
- 4 Click **APPLY CHANGES** to reboot the Radio.

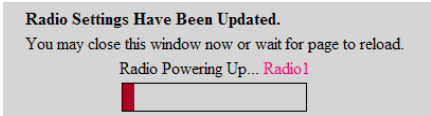

After rebooting successfully, the radio appears as a Repeater radio in the IH Browser window:

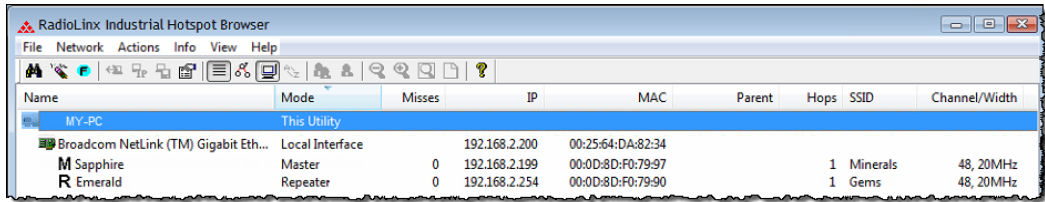

3.5.4 Configuring a Bridging Client Radio

You can configure RLX2-IHx series radios in *Client* or *Bridging Client* modes in the event that you want to connect to third-party 802.11 Access Points. See *Configuring a Client Radio* (page 50) for the differences in the modes. The most straightforward way to test a Client or Bridging Client mode radio configuration is to use a second PC connected as the downstream network device from a Client radio. The following example assumes that there is a second PC, and shows how to connect to the Master radio.

To configure a Bridging Client radio

- 1 Power up a new radio in the default configuration so that it connects to the Master radio.
- 2 Start the IH Browser. After the radio starts, it should appear in the IH Browser.
- 3 In the IH Browser, assign a temporary IP address to the Repeater radio. See *Assigning a Temporary IP Address* (page 39).
- 4 Log into the radio. See *Connecting to the Radio Configuration Interface* (page 40).
- 5 On the **BASIC SETTINGS** tab, in the **BASIC WIRELESS SETTINGS** group, change the radio to **BRIDGING CLIENT** and set the **RADIO NAME** and **SSID** accordingly.

The screenshot displays the configuration interface for a RadioLinx Industrial Hotspot. At the top, the ProSoft Technology logo and RadioLinx Industrial Hotspot™ branding are visible. Below the header, a status bar shows: Radio Name: Emerald, Radio MAC: 00.0D.8D.F0.E5.2A, Radio Type: RLX2-IHNF-A, Update every: 15 sec updating..., Up Time: 0 Day 0 Hr. 6 Min. 14 Sec., Link Time: n/a, Signal Strength: Scanning..., Parent MAC: none, Branch Length: n/a, # Radios Linked: 0, Current Channel: 56, and Link Mode: none. Buttons for Available Parents, Address Table, and Port Status are present.

The main configuration area is divided into tabs: Basic Settings (selected), Advanced Settings, Parent Link, Advanced Network Settings, Serial Settings, QoS, VLAN, NAT, and About. Under the Basic Settings tab, there are three sections: Basic Wireless Settings, Wireless Security Settings, and Access Settings.

Basic Wireless Settings: Radio Name: Emerald, Network SSID: Gems, 802.11 Mode: 802.11n. Radio Mode options: Master (48 (5240 MHz)), Repeater (Parent Auto Select), and **Bridging Client** (selected and highlighted with a red box). Other options include Client (Auto/Specify) and Client MAC (00.00.00.00.00.00).

Wireless Security Settings: Security Mode: WPA/WPA2 Personal, Encryption: AES, WPA Phrase: *****, MAC Filter (Edit Filter), and Hide Network SSID (checkbox).

Access Settings: Obtain IP address - DHCP (selected), Use the following IP address (radio button). IP Address: 192.168.0.254, Subnet Mask: 255.255.255.0, Def. Gateway: 192.168.0.1, Alt IP Address: 0.0.0.0, Alt Subnet Mask: 0.0.0.0. A Download Config button is at the bottom.

At the bottom of the configuration area are buttons for Apply Changes, Cancel Changes, Factory Defaults, and Help. A footer note states: Radio Name: 1 to 31 characters. For user's identification of radio only.

- 6 Click **APPLY CHANGES** to save the configuration.

- 7 Refresh the display in the IH Browser. The radio appears in the IH Browser as a Bridging Client radio:

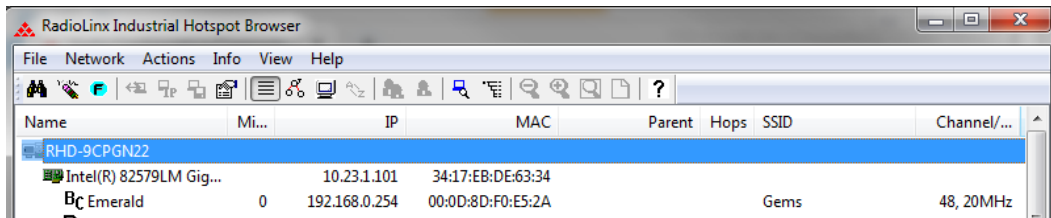

- 8 Configure another Master radio or access point with the correct SSID and Security Settings. This allows the Bridging Client to wirelessly connect.

In this mode, multiple Ethernet devices can connect with any 3rd-party access points (802.11 a/b/g/n).

The following example shows the settings for the Bridging Client radio and the results of the Ping command for the Ethernet device attached to its Ethernet port. The MAC address of the device is displayed by clicking **ADDRESS TABLE** and by selecting **DEVICES OUT OF THE ETHERNET PORT**.

3.5.5 Configuring a Client Radio

You can also configure RLX2-IHx series radios in *Client* mode in the event that you want to connect to third-party 802.11 Access Points. The following table highlights the most significant differences between Repeater, Client, and Bridging Client modes on RLX2-IHx series radios.

	Repeater	Client	Bridging Client
Number of attached Ethernet devices supported	Multiple (up to the limits of network)	One	Multiple (up to 16)
Can other wireless devices connect to the radio?	Yes	No	No
Can the radio connect to non-ProSoft Technology Access Points (Masters)?	No	Yes	Yes
Can I see the radio MAC address on the network?	Repeater radio's MAC address	MAC address of connected device or user-specified MAC address.	Bridging Client radio's MAC address

Client mode is a special mode in the radio that allows a user to connect an Ethernet device to a wireless network through any 802.11a, b, g, or n access point. Any Ethernet device that has an RJ45 Ethernet port can, in effect, become an 802.11a, b, g, or n wireless client by attaching the radio. Only a single device can be connected to the radio in Client mode. Do not connect to more than one Ethernet device (using a switch or hub).

Note: You only use client mode if you need to connect to another brand 802.11a, b, g, or n access point. If you are using RLX2-IHx series radios, you should always use them as repeaters (and masters). Client mode radios are not necessary in Industrial network applications where an RLX2-IHx series Master radio acts as the Access Point. If you don't need a Client RLX2-IHx series radio in the system, you can skip this example configuration.

The most straightforward way to test a Client or Bridging Client mode radio configuration is to use a second PC connected as the downstream network device from a Client radio. The following example assumes that there is a second PC, and shows how to connect to the Master radio.

To configure a Client radio

- 1 Power up a new radio in the default configuration so that it connects to the Master radio.
- 2 Start the IH Browser. After the radio starts, it should appear in the IH Browser.
- 3 In the IH Browser, assign a temporary IP address to the Repeater radio. See *Assigning a Temporary IP Address* (page 39).
- 4 Log into the radio. See *Connecting to the Radio Configuration Interface* (page 40).
- 5 In the **BASIC WIRELESS SETTINGS** group, change the radio to **CLIENT**.

The screenshot displays the configuration interface for a RadioLinx Industrial Hotspot. At the top, the ProSoft Technology logo and RadioLinx Industrial Hotspot™ branding are visible. The main area shows radio status and configuration details:

- Radio Name:** Emerald
- Radio MAC:** 00.0D.8D.F0.E5.2A
- Radio Type:** RLX2-IHNF-A
- Update every:** 15 sec
- Up Time:** 0 Day 0 Hr. 18 Min. 42 Sec.
- Link Time:** n/a
- Signal Strength:** Scanning...
- Parent MAC:** none
- Branch Length:** n/a
- # Radios Linked:** 0
- Current Channel:** 1
- Link Mode:** none

Below the status section is a navigation menu with tabs: Basic Settings, Advanced Settings, Parent Link, Advanced Network Settings, Serial Settings, QoS, VLAN, NAT, and About. The **Basic Settings** tab is selected, showing three sub-sections:

- Basic Wireless Settings:** Radio Name (Emerald), Network SSID (Gems), 802.11 Mode (802.11n), Master (48 (5240 MHz)), Repeater (Parent Auto Select), Bridging Client, **Client** (selected), Client MAC (00.00.00.00.00.00).
- Wireless Security Settings:** Security Mode (WPA/WPA2 Personal), Encryption (AES), WPA Phrase (****), MAC Filter (Edit Filter), Hide Network SSID.
- Access Settings:** Obtain IP address - DHCP (selected), Use the following IP address (IP Address: 192.168.0.254, Subnet Mask: 255.255.255.0, Def. Gateway: 192.168.0.1, Alt IP Address: 0.0.0.0, Alt Subnet Mask: 0.0.0.0), Download Config.

At the bottom, there are buttons for **Apply Changes**, **Cancel Changes**, **Factory Defaults**, and **Help**. A note at the very bottom states: "Client Radio: Allows only 1 device to be attached to Ethernet port. Can be used to connect to third-party Access Points."

- 6 Edit the **RADIO NAME** if desired.
- 7 If you set a temporary IP address in the radio (see *Assigning a Temporary IP Address* (page 39)), set the permanent IP address. On the **BASIC SETTINGS** tab, in the **ACCESS SETTINGS** group, click **OBTAIN IP ADDRESS - DHCP** or **USE THE FOLLOWING IP ADDRESS**.
- 8 Click **APPLY CHANGES** to reboot the Radio. A progress bar is displayed during reboot.

- 9 Refresh the display in the IH Browser. The radio appears in the IH Browser as a Client radio.

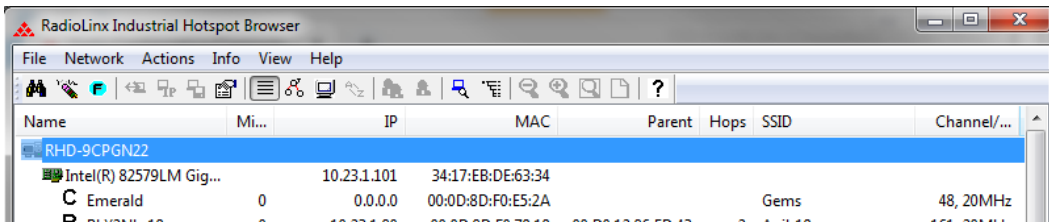

- 10 When the Client radio reboots, connect an Ethernet cable from the radio to the second PC. Wait until the radio registers the MAC address of the PC's network interface (Client mode only).
- 11 Ensure that the IP address of the Ethernet interface on the second PC is on the same subnet as the network for the Client radio. For this example, set the IP address of the PC interface to 192.168.2.248.
- 12 Open a command prompt on the second PC, and verify that you can use the Ping command to ping the IP address of the Master radio.

3.6 Viewing a Radio's Configuration

You can quickly view a radio's configuration.

- 1 Start the IH Browser.
- 2 Right-click the radio and then click **PROPERTIES**.
- 3 If you want to view all the available properties, in the *Detailed Information for Radio* dialog box, click **MORE**.

Note that you cannot change the radio's configuration in this dialog box. If you want to change the configuration, or view more details, see *Configuring a Radio - Getting Started* (page 40) or *Configuring a Radio - Detailed Configuration* (page 54).

3.7 Replacing an Existing Radio

The RLX2-IHx series of industrial hotspots include a microSD card slot for quickly moving the configuration from an installed radio to a replacement using a microSD card. This feature reduces the time to replace a damaged radio.

If you are replacing an existing radio that had a Personality Module (microSD card) installed, then you do not need to manually configure the new radio. Remove the microSD card from the existing radio with the stored configuration and install it in the new radio. When you power up the new RLX2-IHx series radio, the new radio uses all the configuration settings from the microSD card. This feature eliminates the need to manually configure the replacement radio.

By default, the RLX2-IHx series radios writes configuration changes to a microSD card (Personality Module) whenever you make configuration changes if a microSD card is present in the radio. The RLX2-IHx series (by default) also reads the microSD card's configuration when it powers on and uses the stored configuration from the microSD card if the configuration is different than the configuration in the radio's memory.

Important: While this feature can save you time when replacing a radio in the field, it is also a potential security risk. The configuration stored on the microSD could be inserted into another radio, and the radio could then access the network.

The file itself on the microSD card is encrypted so the configuration information (principally the configuration password and encryption key) cannot be extracted. We highly recommend that you physically secure the radio and the microSD card.

If you are not using the Personality Module feature, we recommend that you turn **SD AUTO-CLONE ENABLE** and **SD AUTO-WRITE ENABLE** off. See Personality Module Settings (page 89).

Note: The RLX2-IHNF-W or WC radios do not have a microSD card slot (no Personality Module). For these models, you must manually configure the replacement radio. See *Configuring a Radio - Getting Started* (page 40).

Important: Before installing a new radio, please verify that all listed product items are present. See *Package Contents* (page 19). If any of these components are missing, please contact ProSoft Technology Support for replacements.

4 Configuring a Radio - Detailed Configuration

The RLX2-IHx series radios include a built-in *Web Server* that allows you to both monitor and to configure your radio. The webpages can be displayed from any computer that can connect to the radio through a wired Ethernet connection or a wireless connection.

You can monitor and change the settings for your radio using any type of computer that has a web browser such as Microsoft Internet Explorer, Firefox, or Chrome. These include desktop PCs, laptops, tablets, or smart phones.

4.1 Connecting to the Radio Configuration Interface

This section describes how to connect to the radio using a web browser such as Internet Explorer or Firefox on your PC or other network-enabled device.

To connect to the radio

Important: Your computer or other device must be connected to the same network as the RLX2-IHx series radio.

- 1 Log into the radio. You can do this in any of three ways:
 - In the IH Browser List view or Topography view, right-click the radio and then click **CONNECT**.
 - In the IH Browser List view or Topography view, double-click the radio.
 - Open a web browser on your PC, and then in the address bar, type `http://`, followed by the IP address for the radio, and then press **ENTER**. For example, `http://192.168.6.10`.

The login screen appears in the web browser.

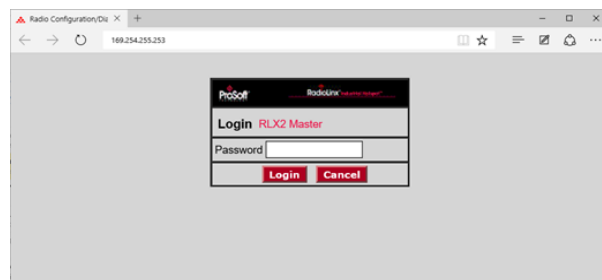

- 2 Enter the password and then click **LOGIN**. The default password is *password*.

If the radio is set to factory defaults, see *Connecting to the Radio Web Configuration Interface* (page 40) for entering an initial password to enable the configuration tabs. If you have lost the password for the radio, you can reset the radio to its default settings. See *Resetting a RLX2-IHx series Radio* (page 180).

This opens the main configuration webpage for the radio. Note that some parameters may be different from the image depending on your specific radio model.

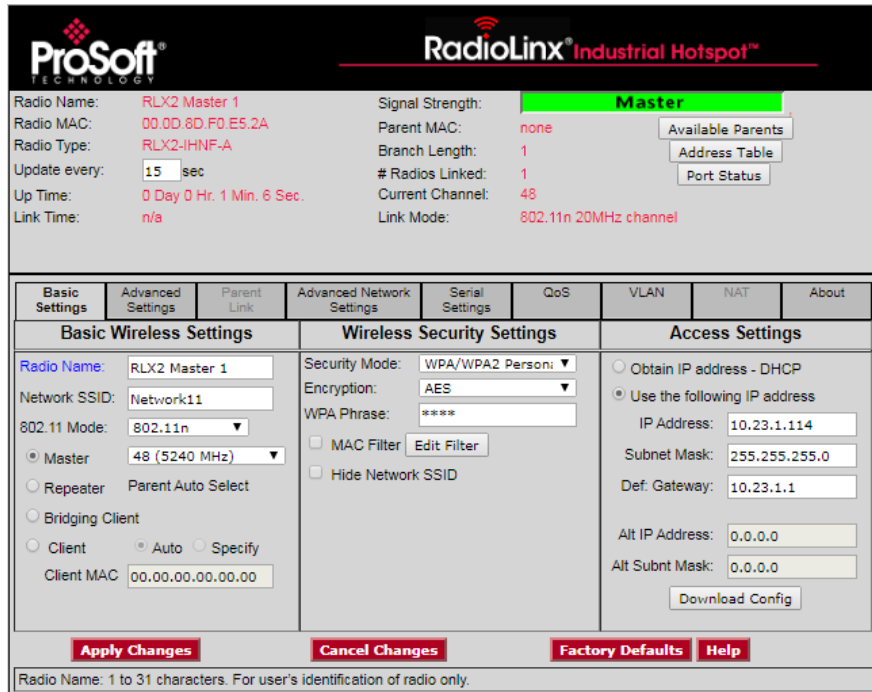

Tip: You can display the help topic for any parameter on the webpage by clicking the parameter name. The parameter name turns blue when you move the cursor over a parameter with a help topic. There is also a short description at the bottom of the window.

4.1.1 Read-Only Fields

Some of the parameters are for display, and only provide information about the state of the radio.

Note that depending on the model of the radio, and the radio configuration, some parameters and buttons may not be available or appear on the page.

4.1.2 Configuration Help

Help is available for each item on the page.

To view a brief help message about any parameter on the screen, move the cursor over the parameter until the parameter name turns blue, or press the **TAB** key to select the parameter. Refer to the text that appears at the bottom of the screen.

The screenshot displays the configuration interface for a RadioLinx Industrial Hotspot. At the top, the ProSoft Technology logo and the product name 'RadioLinx Industrial Hotspot' are visible. Below this, a summary section shows key parameters: Radio Name (RLX2 Master 1), Radio MAC (00.0D.8D.F0.E5.2A), Radio Type (RLX2-IHNF-A), Update every (15 sec), Up Time (0 Day 0 Hr. 1 Min. 6 Sec.), Link Time (n/a), Signal Strength (Master), Parent MAC (none), Branch Length (1), # Radios Linked (1), Current Channel (48), and Link Mode (802.11n 20MHz channel). Buttons for 'Available Parents', 'Address Table', and 'Port Status' are present.

The main configuration area is divided into several tabs: Basic Settings, Advanced Settings, Parent Link, Advanced Network Settings, Serial Settings, QoS, VLAN, NAT, and About. The 'Basic Settings' tab is active, showing three sub-sections: Basic Wireless Settings, Wireless Security Settings, and Access Settings.

- Basic Wireless Settings:** Radio Name (RLX2 Master 1), Network SSID (Network11), 802.11 Mode (802.11n), Master (48 (5240 MHz)), Repeater (Parent Auto Select), Bridging Client, Client (Auto), Client MAC (00.00.00.00.00.00).
- Wireless Security Settings:** Security Mode (WPA/WPA2 Personal), Encryption (AES), WPA Phrase (****), MAC Filter (unchecked), Hide Network SSID (unchecked).
- Access Settings:** Obtain IP address - DHCP (unchecked), Use the following IP address (checked), IP Address (10.23.1.114), Subnet Mask (255.255.255.0), Def. Gateway (10.23.1.1), Alt IP Address (0.0.0.0), Alt Subnet Mask (0.0.0.0).

At the bottom of the configuration area, there are buttons for 'Apply Changes', 'Cancel Changes', 'Factory Defaults', and 'Help'. A help message is displayed at the very bottom: 'Radio Name: 1 to 31 characters. For user's identification of radio only.'

To view more help about the selected parameter, click the parameter name. This action opens a help page in a new browser window.

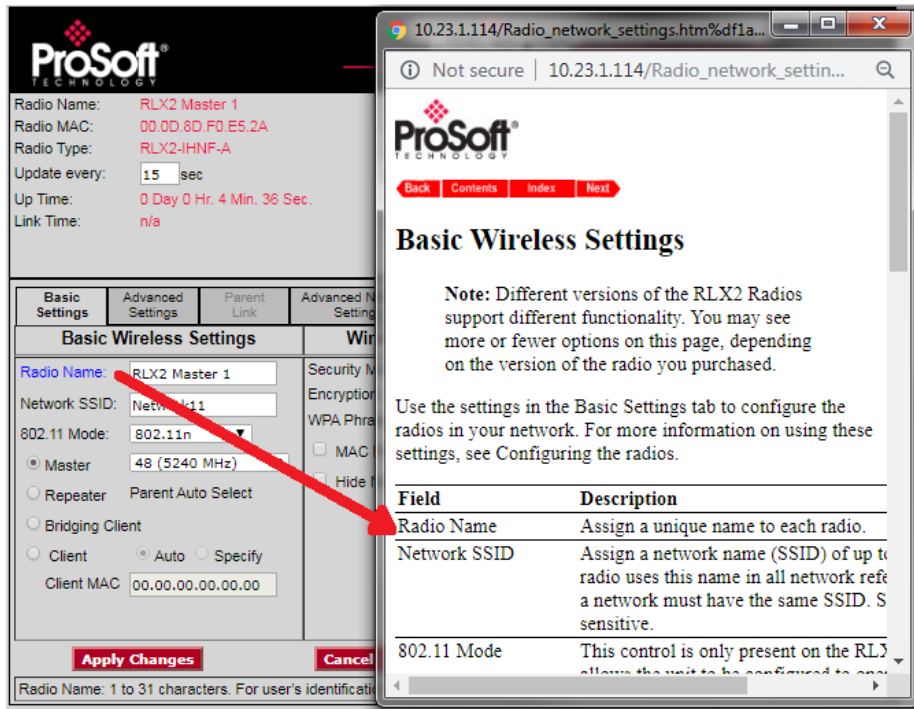

To view the complete online documentation for the RLX2-IHx series radio, click the **Help** button. This action opens the online documentation in a new browser window. Use the **Contents**, **Index** and **Search** tabs in the left frame to navigate the help system.

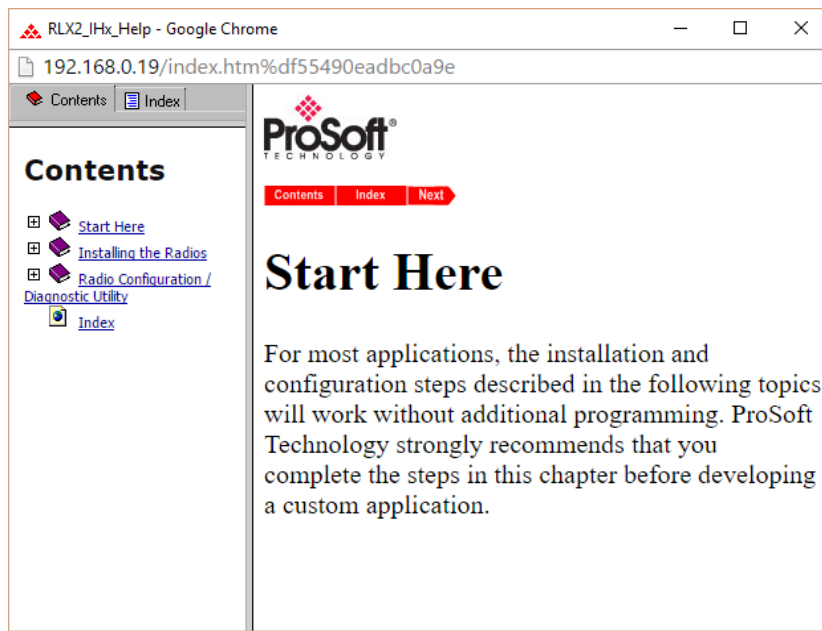

4.1.3 Apply Changes

Click **APPLY CHANGES** to save changes to the radio configuration and restart the radio with the new configuration. A progress bar appears after you click **APPLY CHANGES**.

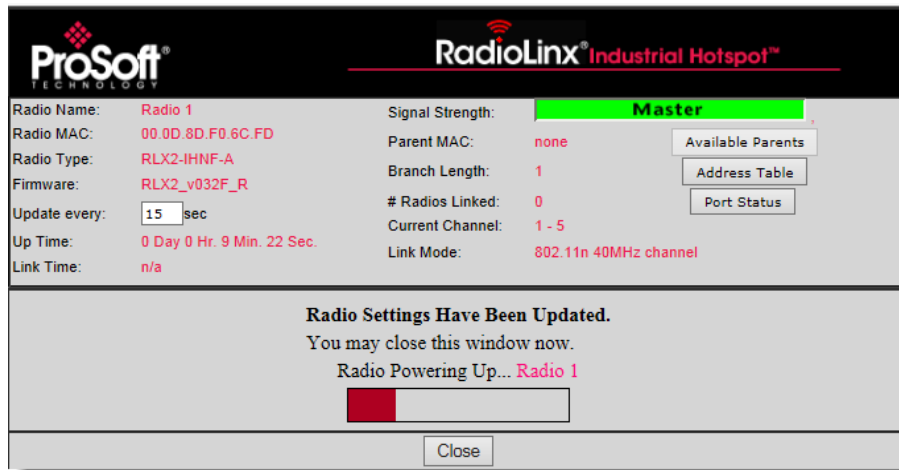

4.1.4 Cancelling Changes

Click **CANCEL CHANGES** to discard any changes to the radio configuration you made during this session.

Note: This button only applies to changes made since you last clicked **APPLY CHANGES** on the RLX2.

4.1.5 Factory Defaults

Click **FACTORY DEFAULTS** to reset the radio to the original default settings.

Important: This action discards all changes you have made to the radio configuration settings.

Two things to note if there is a microSD card in the radio's Personality Module slot.

- Clicking **FACTORY DEFAULTS** does not reset the configurations stored on the microSD Card in the radio's Personality Module slot.
- If you select **SD AUTOWRITE ENABLE** on the **ADVANCED SETTINGS** tab, the radio overwrites the configuration on the microSD card with the factory default settings if you click **APPLY CHANGES**. See *Personality Module Settings* (page 89).

4.2 Viewing Radio Status

The RLX2-IHx series radio status parameters appear at the top of the RLX2-IHx webpage.

The screenshot displays the configuration interface for a RadioLinX Industrial Hotspot. At the top, the ProSoft Technology logo and the product name 'RadioLinX Industrial Hotspot' are visible. Below this, a status summary section is highlighted with a red box, containing the following information:

- Radio Name: RLX2 Master 1
- Radio MAC: 00.0D.8D.F0.E5.2A
- Radio Type: RLX2-IHNF-A
- Update every: 15 sec
- Up Time: 0 Day 0 Hr. 1 Min. 6 Sec.
- Link Time: n/a
- Signal Strength: Master (indicated by a green bar)
- Parent MAC: none
- Branch Length: 1
- # Radios Linked: 1
- Current Channel: 48
- Link Mode: 802.11n 20MHz channel

Below the status summary is a navigation menu with tabs for Basic Settings, Advanced Settings, Parent Link, Advanced Network Settings, Serial Settings, QoS, VLAN, NAT, and About. The 'Basic Settings' tab is selected, showing three main sections:

- Basic Wireless Settings:** Radio Name (RLX2 Master 1), Network SSID (Network11), 802.11 Mode (802.11n), Channel (48 (5240 MHz)), and radio mode options (Master, Repeater, Bridging Client, Client).
- Wireless Security Settings:** Security Mode (WPA/WPA2 Personal), Encryption (AES), WPA Phrase (*****), and checkboxes for MAC Filter and Hide Network SSID.
- Access Settings:** IP address configuration options (Obtain IP address - DHCP or Use the following IP address) with fields for IP Address (10.23.1.114), Subnet Mask (255.255.255.0), Def. Gateway (10.23.1.1), Alt IP Address (0.0.0.0), and Alt Subnet Mask (0.0.0.0).

At the bottom of the configuration page are buttons for 'Apply Changes', 'Cancel Changes', 'Factory Defaults', and 'Help'. A footer note states: 'Radio Name: 1 to 31 characters. For user's identification of radio only.'

Note: Different versions of the RLX2-IHx series radios and firmware support different functions. There may be fewer or more parameters on this page, depending on the version of the radio and firmware.

Most of the parameters in the radio status area are read-only, and display the current settings and status for this radio.

Parameter	Description
Radio Name	The user-assigned name for the radio.
Radio MAC	MAC address of the selected radio. The MAC ID is also printed on the side of the radio.
Radio Type	The Model Number of this radio; for example: <i>RLX2-IHA</i> , <i>RLX2-IHG</i> , <i>RLX2-IHNF</i> , or <i>RLX2-IHW</i> .
Firmware	The version of firmware currently installed in the radio. All radios on the network must have the same firmware versions to guarantee proper operations. For more information on firmware versions, see <i>Updating the Radio Firmware</i> (page 135).
Update every	The number of seconds the webpage waits between refreshing the data. To change the value temporarily, enter the new value and press the TAB key.
Up Time	The length of time the radio has operated since the last system power-up or reset.
Link Time	The length of time that the radio has been continuously connected to the parent.
Signal Strength	The strength of the signal from the parent.
Parent MAC	The MAC address of the parent to which the radio is linked.
Branch Length	The number of RF links from the radio to the Master radio.
# Radios Linked	The number of other radios that are linked to this radio.
Current Channel	The current operating channel for the radio. For a Master radio, this is the channel set in the <i>Basic Wireless Settings</i> . For a Repeater radio, this is the same channel as the linked parent. When the LINK MODE parameter shows that the unit is in 40 MHz mode, this parameter shows the main channel number, followed by the extension channel's number.
Link Mode	The 802.11 Mode in which the radio is operating (a/b/g/n). For a Master radio, this is the highest mode supported. For a Repeater radio, this is the highest common mode supported by both: <ul style="list-style-type: none"> ▪ The settings of the Repeater radio and its parent ▪ The capability of the radio channel.
Available Parents	Click this button to view the list of Access Points and Bridges (Parents) from which this radio can detect beacons. This button is only available when the radio is in Repeater mode (set in the <i>Basic Wireless Settings</i>). See <i>Viewing Available Parents for a Radio</i> (page 61).
Address Table	Click this button to view a list of MAC addresses for devices in the radio's address table. See <i>Viewing the Radio Address Table</i> (page 63).
Port Status	Click this button to view the active ports on this radio. See <i>Viewing the Radio Port Status</i> (page 64).

4.2.1 Viewing Available Parents for a Radio

To view the *Available Access Points* table, click **AVAILABLE PARENTS**. This table is only available when the radio is in Repeater or a Client mode.

MAC ID	SSID	Channel	RSSI	Security	Encrypt	Speed	Cost	Age (s)	Hops
00:24:01:e9:a2:8e	ENGINEERING WIRELESS	10	-74	WPA-PSK	TKIP	g	273	0	na
02:2b:cb:8e:e8:2b	HP787DF0	10	-70	none	none	b	225	0	na
20:9f:db:b1:b5:1b	PSFT-Primary	1	-73	WPA&2 Ent	AES	n	260	2	na
26:9f:db:b1:b5:1b	PSFT-Guest	1	-74	WPA&2 PSK	AES	n	273	2	na
2a:9f:db:b1:b5:1b	PSFT-Backup	1	-75	WPA&2 PSK	AES	n	286	2	na
2e:9f:db:b1:b5:1b	BGW	1	-73	WPA&2 Ent	AES	n	260	2	na
c2:9f:db:b1:6e:9c	BGW	36	-77	WPA&2 Ent	AES	n	314	0	na
c6:9f:db:b1:6e:9c	BGW-Guest	36	-77	WPA&2 PSK	AES	n	314	0	na
ca:9f:db:b1:6e:9c	BGW-Mobile	36	-77	WPA&2 PSK	AES	n	314	0	na

This page is helpful for viewing:

- The possible parents for a repeater. The current parent should normally be the radio with the lowest cost and a matching SSID.
- Other 802.11 networks in the area.

Note: You can click on a column header to sort the table by the values in that column

Parameter	Description
Only Show Same SSID	Select this check box to restrict the list of available parents to those with the same SSID as the radio you are configuring.
Refresh	Click this button to re-scan the network and update the devices in the list.
Mac ID	Displays the unique hexadecimal number that identifies an available Ethernet devices.
SSID	Displays the network name (Service Set Identifier) that identifies an available Ethernet device.
Channel	The radio channel on which the device is transmitting. The channel list indicates the channel number as well as the frequency (2.4 GHz or 5 GHz bands). Important: The RLX2-IHx series radio is supplied with a dual-band antenna that supports both frequency ranges. If you use a different antenna with the RLX2-IHx series radio, you must choose a channel and frequency range supported by the antenna. See <i>Appendix G - Antenna Configuration</i> (page 215).
RSSI	Displays the Received Signal Strength Indication.
Security	Displays the security mode enabled for the device.
Encrypt	Displays the encryption type enabled for the device
Speed	Displays the IEEE 802.11 connection speed (a, b, g or n). The RLX2-IHx series radio supports all of these 802.11 connection speeds.

Parameter	Description
Cost	Displays the calculated parent selection cost. The radio evaluates the link it has to its parent once per second to determine if this link is the best parent to use. The radio calculates the cost for each entry. The cost calculation is based not only on the strongest signal, but on several other factors to provide optimum network communication.
Age(s)	Displays the length of time (in seconds) since the radio last saw a packet from this MAC address (device).
Hops	Displays the number of hops to the Master device. A value of 0 (zero) appears for non-ProSoft Technology devices.

- This list contains both 802.11 devices that are part of the same SSID as the RLX2-IHx series itself (for example, *Minerals*) as well as devices that belong to different SSIDs (for example, *Network1* and *ProSoftInternal*). This list is updated continuously.
- The radio updates this list with each 802.11 packet that is received, whether from a radio of the same network or one that belongs to another SSID. It can also see radios from other vendors.

4.2.2 Viewing the Radio Address Table

To view the RLX2 Address Table, click **ADDRESS TABLE**.

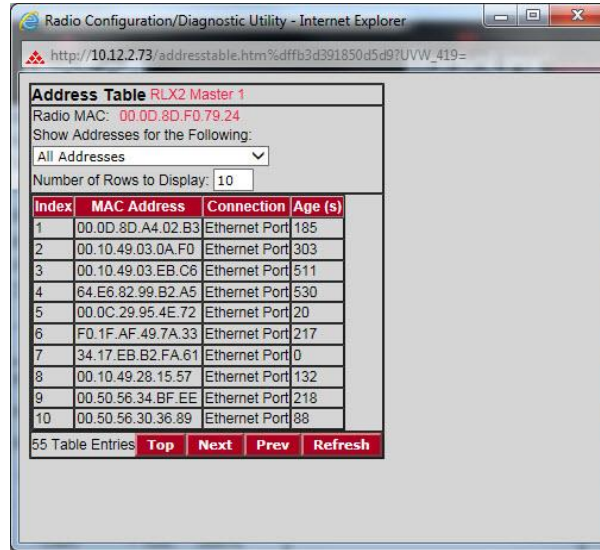

The Address Table shows the port through which each device (MAC address) is connected, along with the age in seconds since the radio last saw a packet from this MAC address.

Parameter	Description
Radio MAC	Displays the MAC address of the radio you are configuring. The MAC ID is also printed on the side of the radio.
Show Addresses for the Following	<p>Allows you to filter the address list. Options are:</p> <ul style="list-style-type: none"> ▪ ALL ADDRESSES ▪ DEVICES OUT ETHERNET PORT ▪ DIRECTLY LINKED RADIOS/CLIENTS ▪ DEVICES BEYOND DIRECT RF LINKS <p>When you select DIRECTLY LINKED RADIOS/CLIENTS, the table displays an additional RSSI column, showing the Received Signal Strength (RSS) from each radio or client linked to the radio.</p> <p>When you select ALL ADDRESSES, the RLX2-IHx series radio operates as an AeroScout sensor. Each Wi-Fi device detected and reported to the AeroScout engine appears as <i>Detected Wi-Fi device</i>.</p>
Number of Rows to Display	Defines how many MAC addresses to display at one time. Click NEXT and PREV to scroll through the available MAC addresses.
Index	Displays the device position in the list.
MAC Address	Displays the MAC address for each device.
Connection	Displays the connection type for each device.
Age (s)	Displays the length of time (in seconds) since the radio last saw a packet from this MAC address
Top	Click this button to display the top of the table. The table displays updated data.
Next / Prev	Click these buttons to move up and down through the table.
Refresh	Click this button to update the data in the table.

4.2.3 Viewing the Radio Port Status

To view the *Port Status* Table, click **PORT STATUS**.

This table shows all of the active ports on the radio. This window displays information about the current **SPANNING TREE** including the MAC address of the **SPANNING TREE ROOT** device, and the timing parameters for the current Spanning Tree. Each RLX2-IHx series radio can have up to 34 active ports – one Ethernet cable, one parent RF link, and up to 32 child RF links.

The primary reason for creating a Spanning Tree is that it allows you to create fully redundant paths. If any single radio in a redundant path loses its connection, and if another path still exists, the radio updates the connection to communication restored.



Parameter	Description
Spanning Tree Protocol: Wireless Ports	The Spanning Tree Protocol level for the wireless port (Rapid STP or STP).
Ethernet Port	The Spanning Tree Protocol level for the Ethernet port (Rapid STP or STP).
Edge Port	Displays <i>Active</i> or <i>Inactive</i> based on the setting of <i>Ethernet Edge Port</i> in the <i>Spanning Tree</i> configuration dialog.
Spanning Tree Root: MAC	The MAC ID of the root device in the spanning tree.
Priority	Spanning Tree device with the lowest-priority value is elected the root of the tree
Max Age	The length of time a port can stay enabled without any new spanning updates.
Hello Time	The length of time between the transmission of spanning update packets.
Forward Delay	The length of time a port must listen for spanning information before being activated.
#	Position in the list. Each page shows up to 10 ports. Use the Next and Previous buttons to move up and down through the table.
Connection	This parameter indicates what the port represents: Ethernet, a Parent radio, or a Child radio.
State	The current Spanning Tree state of the port. Possible states are Blocking, Learning, Listening, and Forwarding. Forwarding packets can be transferred.
Designation	The Spanning Tree designation for the branch off the port. Possible designations are Root (ports going to the root), Designated (ports going to a branch), or Normal.

Parameter	Description
Path Cost	The cumulative cost of all wired and wireless links from the port to the Spanning Tree root.
Designated Bridge	The Next bridge toward the Spanning Tree root for this port.
Top	Click the TOP button to see the top of the table.
Next / Prev	If the table has more ports than it can display in the window, use the NEXT and PREV buttons to move up and down through the table.
Refresh	Click REFRESH to update the table.

The following illustration shows the IH Browser application provided with the radios. Notice it shows the radio named *Hematite_4F*, linked to *Amethyst_BD*. This link is shown with a red dotted line. Also visible is the level of redundancy in their network. Each of the blue lines represents an alternate parent. From this view, it is easily shown how much redundancy exists in their network.

To display the redundant paths, select the toolbar button denoting two "parents." To view the redundancy on a per-radio basis, select the single **Parent** button, and then click on the radio to view its available redundancies.

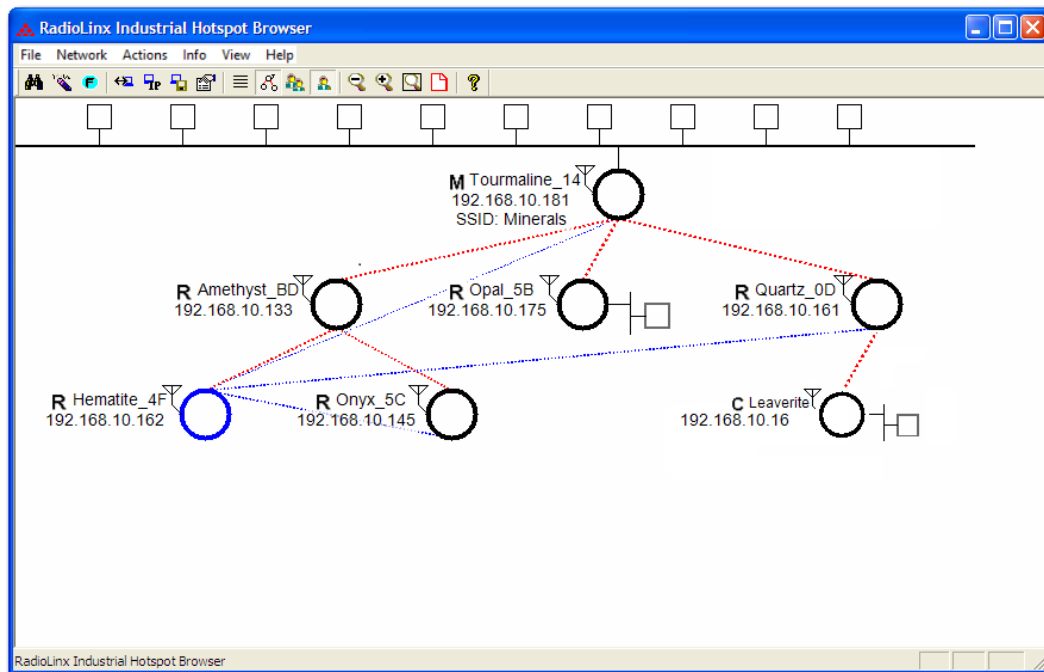

4.3 Configuring Basic Settings

The **BASIC SETTINGS** tab includes three groups:

- **BASIC WIRELESS SETTINGS**
- **WIRELESS SECURITY SETTINGS**
- **ACCESS SETTINGS**

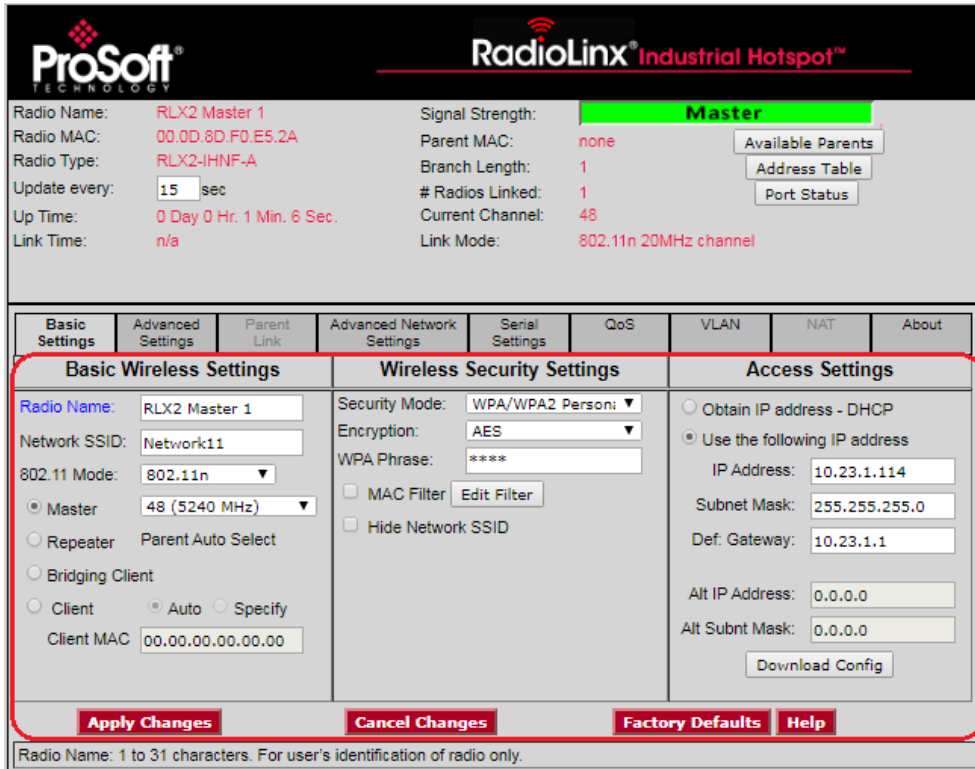

ProSoft TECHNOLOGY **RadioLinX** Industrial Hotspot™

Radio Name: **RLX2 Master 1** Signal Strength: **Master**
Radio MAC: **00.0D.8D.F0.E5.2A** Parent MAC: **none** Available Parents
Radio Type: **RLX2-IHNF-A** Branch Length: **1** Address Table
Update every: **15** sec # Radios Linked: **1** Port Status
Up Time: **0 Day 0 Hr. 1 Min. 6 Sec.** Current Channel: **48**
Link Time: **n/a** Link Mode: **802.11n 20MHz channel**

Basic Settings	Advanced Settings	Parent Link	Advanced Network Settings	Serial Settings	QoS	VLAN	NAT	About
Basic Wireless Settings	Wireless Security Settings	Access Settings						

Basic Wireless Settings
Radio Name:
Network SSID:
802.11 Mode:
 Master
 Repeater Parent Auto Select
 Bridging Client
 Client Auto Specify
Client MAC:

Wireless Security Settings
Security Mode:
Encryption:
WPA Phrase:
 MAC Filter
 Hide Network SSID

Access Settings
 Obtain IP address - DHCP
 Use the following IP address
IP Address:
Subnet Mask:
Def. Gateway:
Alt IP Address:
Alt Subnet Mask:

Radio Name: 1 to 31 characters. For user's identification of radio only.

4.3.1 Basic Wireless Settings

You use the parameters in the **BASIC WIRELESS SETTINGS** group to define the identity of your RLX2-IHx series radio.

The screenshot displays the configuration page for a ProSoft Radiolinx Industrial Hotspot. The 'Basic Wireless Settings' section is highlighted with a red border. It includes the following fields and options:

- Radio Name:** RLX2 Master 1
- Network SSID:** Network11
- 802.11 Mode:** 802.11n
- Radio Mode:** Master (selected), 48 (5240 MHz)
- Repeater:** Parent Auto Select
- Bridging Client:** (unselected)
- Client:** Auto (selected), Specify
- Client MAC:** 00.00.00.00.00.00

Other visible settings include Security Mode (WPA/WPA2 Personal), Encryption (AES), WPA Phrase (****), and IP address settings (10.23.1.114). Buttons for 'Apply Changes', 'Cancel Changes', 'Factory Defaults', and 'Help' are at the bottom.

Note: Different versions of the RLX2-IHx series radios and firmware support different functions. There may be fewer or more parameters on this page, depending on the version of the radio and firmware.

Parameter	Description
Radio Name	Specifies a unique name for the radio you are configuring.
Network SSID	Specifies a network name (SSID) of up to 32 characters. The radio uses this name in all network references. All radios in a network must have the same SSID. Note: SSID names are case-sensitive.

Parameter	Description
802.11 Mode (RLX2-IHNF only)	<p>This control only appears when configuring a model RLX2-IHNF radio. Specifies whether the radio operates in 802.11 a/g mode or in 802.11n mode (default). In addition, it specifies whether the radio allows use of 40 MHz wide channels for Child clients.</p> <p>Note: A Repeater radio automatically uses a mode that is compatible with the Parent radio settings. For example, an RLX2-IHNF radio may connect to an RLX2-IHW Master radio which only operates in 802.11a/g mode, and still use 802.11n mode for any Child Repeater radios.</p> <p>802.11A/G - The radio acts as an 802.11a radio on the 5 GHz band, and an 802.11g radio on the 2.4 GHz band. Data rates are limited to the 802.11 a/g rates (54 mbps maximum, and. 802.11n operational features are disabled. It is not necessary to select this mode for RLX2-IHNF radios to link to other RLX2-IHx series or RLXIB series radios. These radios link at their best possible speeds regardless of mode. This mode is not commonly used. It is mainly used to allow 802.11 a/b/g client devices that cannot link to 802.11n devices to work. One example of such a device is the ProSoft 1734-AENTR wireless I/O client.</p> <p>802.11N - The default operational mode of the RLX2-IHNF radio. All 802.11n features are operational, and the radio uses 20 MHz wide channels.</p> <p>802.11.N WIDE - Utilizes adjacent pairs of 20 MHz-wide channels as a single 40 MHz-wide channel. This allows the fastest data throughput to other 802.11n devices. Only 802.11n devices can utilize this mode, but all RLX2-IHx series radios link at their best speed regardless of mode. Channels in the 5 GHz band are 20 MHz apart, so the 802.11n wide mode occupies only two channels in that band. However, channels in the 2.4 GHz band are spaced only five MHz apart, so 802.11n wide mode in the 2.4 GHz band occupies <i>eight adjacent channels!</i> Since there are at most 13 channels in the 2.4 GHz band, and only three channels do not overlap others, we do not recommend enabling wide mode on 2.4 GHz band channels.</p>
Master	<p>Specifies that this radio is a Master radio. The Master radio is the root device in a network. You must have at least one Master radio in your network. For redundancy, you can assign more than one Master to a network. See <i>Setting Up a Master Radio</i> (page 43).</p>
Available Channel List (Master radio only)	<p>Specifies the channel number, the frequency band (2.4 GHz, 5 GHz DFS, or 5 GHz), and the channel frequency in MHz.</p> <p>For RLX2-IHNF radios:</p> <p>When you set 802.11 MODE to 802.11N WIDE, each entry shows the main channel number, followed by the extension channel number if the particular channel supports 40 MHz.</p> <p>The 20 MHz channels are used whenever sending frames at an 802.11 a/g data rate (for example, Beacons at 6 Mbits). The main and extension channels are used together for 802.11n data rate transmissions. Note that the frequency indicated when in 802.11n wide mode is the center of the 40 MHz channel pair.</p> <p>Important: The RLX2-IHx series radio is not supplied with an antenna. When choosing an antenna for use with your RLX2-IHx series radio, you must choose one that supports the frequency range set in the configuration for the radio. See <i>Appendix G - Antenna Configuration</i> (page 215).</p>

Parameter	Description
Repeater	Specifies that this radio is a Repeater radio. Repeater mode is the normal mode for the radios in the network that are not the Master radio. The Master radio specifies the network channel and is the root of the radio network tree. Repeater radios extend the range of a network and create the signal bridges that allow networked radios to communicate over a greater distance. All RLX2-IHx series radios are capable of being Repeaters. See <i>Configuring a Repeater Radio</i> (page 45).
Bridging Client	Specifies a special mode for use where there are multiple Ethernet devices that need to connect to any 3 rd -party 802.11 a, b, g, or n Access Points (AP). This mode uses a Layer 2 Network Address Translation mechanism, and can only work for IP-based protocols. If using non-IP-based protocols, then specify Client mode for this radio. See <i>Configuring a Bridging Client Radio</i> (page 47).
Client	This is a special mode that allows you to transparently connect a single Ethernet device to any non-ProSoft 802.11 a, b, g, or n Access Point (AP). To the AP, the MAC address of the Ethernet device would appear to be an 802.11 wireless client. Client mode supports all network protocols. See <i>Configuring a Client Radio</i> (page 50).
Auto / Specify (Client mode only)	Choose SPECIFY only if the device does not send out any unsolicited Ethernet packets. Try AUTO first.
Client MAC	Specify the MAC ID of the device connected to this radio, only if the device does not advertise its MAC address.

4.3.2 Wireless Security Settings

You use the parameters in the **WIRELESS SECURITY SETTINGS** group to define the wireless security parameters for your RLX2-IHx series radio.

The screenshot shows the configuration interface for a RadioLinX Industrial Hotspot. The top section displays radio information: Radio Name (RLX2 Master 1), Radio MAC (00.0D.8D.F0.E5.2A), Radio Type (RLX2-IHNF-A), Update every (15 sec), Up Time (0 Day 0 Hr. 1 Min. 6 Sec.), Link Time (n/a), Signal Strength (Master), Parent MAC (none), Branch Length (1), # Radios Linked (1), Current Channel (48), and Link Mode (802.11n 20MHz channel). Below this is a tabbed interface with tabs for Basic Settings, Advanced Settings, Parent Link, Advanced Network Settings, Serial Settings, QoS, VLAN, NAT, and About. The 'Wireless Security Settings' tab is active and highlighted with a red box. It contains the following fields: Security Mode (WPA/WPA2 Personal), Encryption (AES), WPA Phrase (****), MAC Filter (checkbox), and Hide Network SSID (checkbox). To the right of the security settings is the 'Access Settings' group, which includes options for obtaining an IP address (DHCP or static) and fields for IP Address, Subnet Mask, Def. Gateway, Alt IP Address, and Alt Subnet Mask. At the bottom of the interface are buttons for 'Apply Changes', 'Cancel Changes', 'Factory Defaults', and 'Help'. A footer note states: 'Radio Name: 1 to 31 characters. For user's identification of radio only.'

The parameters that appear in the Wireless Security Settings group depending on your selections these in other parameters:

- **SECURITY MODE**
- **802.11 MODE** (model RLX2-IHNF radio only)
- **MASTER, REPEATER, BRIDGING CLIENT, or CLIENT** radio modes

The parameters in the Wireless Security Settings group automatically change if necessary when you make a change in any of these parameters. You do not have to click **APPLY CHANGES** to see the changes in the Wireless Security Settings.

Note: Different versions of the RLX2-IHx series radios and firmware support different functions. There may be fewer or more parameters on this page, depending on the version of the radio and firmware.

Parameter	Description
Security Mode	<p>Specifies the security mode for the radio, as well as Legacy WEP encryption modes for interoperability with Legacy devices.</p> <p>NONE - (not recommended)</p> <p>PERSONAL - Security mode using a pre-shared key for networks that don't require an authentication server.</p> <p>ENTERPRISE - Security mode requiring the use of an external RADIUS authentication server. For more information see Enterprise Mode Settings (page 75).</p> <p>WEP - Legacy security setting using either a 64 or 128-bit key and WEP encryption.</p> <p>The following protocols are available with both Personal and Enterprise security modes:</p> <ul style="list-style-type: none"> ▪ WPA - Original protocol introduced to replace WEP. ▪ WPA2 - Latest 802.11 security protocol conforming to the 802.11i standard. ▪ WPA/WPA2 - Allows client devices to connect using WPA if they do not support WPA2.
Encryption	<p>Specifies the encryption method for the radio. AES is the preferred encryption mechanism as it is the most secure protocol supported by the 802.11 standard. If using legacy devices that do not support AES, you can choose combinations of legacy methods depending on the 802.11 mode setting.</p> <p>NONE - (Not recommended)</p> <p>AES – (Recommended) This can be used with all Personal and Enterprise modes.</p> <p>TKIP - Only TKIP encryption. This setting is only available when in 802.11a/g mode. The 802.11n standard does not allow TKIP as the only encryption mechanism.</p> <p>AES AND TKIP - Allows client devices that don't support AES to connect to the radio. This setting is available in all 802.11 modes.</p> <p>TKIP AND WEP128 - Allows client devices that don't support TKIP to connect to the radio. This setting is only available in 802.11a/g mode. Note that combinations including WEP and AES are not allowed.</p> <p>WEP128 - Legacy security setting using a 128-bit key and WEP encryption. This setting is only available when you select the WEP Security Mode.</p> <p>WEP64 - Legacy security setting using a 64-bit key and WEP encryption. This setting is only available when you select the WEP Security Mode.</p> <p>For more information, see Encryption Type (page 73).</p>
WPA phrase	<p>Specifies the WPA pass phrase of between eight and 63 normal keyboard characters. This control is present when you select any of the PERSONAL Security Modes. If a WPA or WPA2 Personal Security Mode is selected, enter a WPA phrase of between eight and 63 normal keyboard characters.</p> <p>This phrase automatically generates an encryption key of 128 hexadecimal characters. The default WPA Phrase is: passphrase</p>
WEP Key	<p>Specifies the WEP key.</p> <ul style="list-style-type: none"> ▪ For WEP64, enter either 5 normal text characters or 10 hexadecimal characters in the this parameter. ▪ For WEP128, enter either 13 normal text characters or 26 hexadecimal characters in the this parameter. <p>For more information, see <i>WEP Key</i> (page 74).</p>
MAC Filter	<p>Select this check box to restrict connections by MAC address, then define the acceptable MAC addresses by clicking EDIT FILTER. See MAC Filter (page 72).</p>
Edit Filter	<p>Specifies the acceptable MAC addresses.</p>
Hide Network SSID	<p>Select this check box to hide the NETWORK SSID (defined in the BASIC WIRELESS SETTINGS group) from other 802.11 users. Clients can still connect to the radio network by manually entering the Network SSID.</p>

MAC Filter

To view the *MAC Filter* table click the **BASIC SETTINGS** tab, then in the **WIRELESS SECURITY SETTINGS** group, select the **MAC FILTER** checkbox, and finally click **EDIT FILTER**. The MAC Filter table defines the acceptable MAC addresses when you configure the radio to use MAC filtering. See *Wireless Security Settings* (page 70).

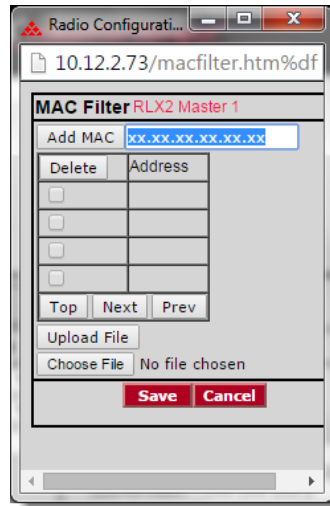

Parameter	Description
Add MAC	Enter the MAC address to add to the table. This address appears in the list after you click ADD MAC .
Delete	Deletes the selected MAC address from the list. You first select the addresses to delete by selecting the checkbox next to the address.
Address	Displays the acceptable MAC addresses that can connect to the radio.
Top	Jumps to the top of the list.
Next / Prev	Navigates up and down through the address list.
Upload File	Imports a pre-defined list of MAC addresses. This allows you to use the same list of MAC addresses in several radios <ol style="list-style-type: none"> 1 Open a text editor such as Notepad.exe. 2 Enter the MAC addresses in hexadecimal format, one MAC address per line, including the periods (for example, 00.0C.8D.F0.76.95). 3 When finished, save the text file. 4 In the MAC Filter window, click CHOOSE FILE to select the text file. 5 Click UPLOAD FILE to upload the selected list of MAC addresses.
Choose File	Selects a file of MAC addresses to upload.

Encryption Type

We recommend that you use WPA or WPA2 (Wi-Fi Protected Access) using AES for the **SECURITY MODE** and **ENCRYPTION**.

- Use TKIP with an older client radio that does not support AES.
- Use WEP (Wired Equivalency Protocol) with an older client radio that does not support AES or TKIP.
- For compatibility with clients that do not support WPA, you can select TKIP+WEP128 for the **ENCRYPTION**.
- Older clients can connect to the RLX2-IHx series radio using the WEP setting, but all other links use the more secure WPA encryption.

Important: If the 802.11n data rates are supported and enabled in the RLX2-IHx series radio, then all TKIP and TKIP/WEP options are disabled. If a client radio only supports TKIP, then use the **AES AND TKIP** option. If the client radio only supports WEP, then in the **802.11 MODE** parameter, select **802.11 A/G** and then select the appropriate WEP setting.

Important: If you select **TKIP+WEP128**, some clients using WPA might not be able to connect unless you use a WEP key other than number 1, due to limitations in these clients. In such cases, you should set **WEP KEY** number to a value other than 1 and set this same key for all clients that are using WEP. See *WEP Key* (page 74).

When you select **WEP** for the **SECURITY MODE**, the WEP128 or WEP64 encryption types are available but neither are recommended.

WEP is the original security protocol used by 802.11 networks but should only be used if interoperability with a legacy device is essential. Tools are available that allow an attacker to break the WEP keys simply by sniffing an active WEP network for a few minutes. WPA offers vastly better protection against attacks. WPA distances the encryption key from the actual data by performing several algorithms to create a *Session key* before encrypting any data, and it performs dynamic key management by changing keys frequently.

Note: If an RLX2-IHx series radio is set to use TKIP+WEP128, it can connect to other radios set to WPA only or WPA+WEP, but it will not communicate with radios using only WEP. Likewise, an RLX2-IHx series radio in Client mode with TKIP+WEP128 selected will not connect to an access point using only WEP.

WEP Key

A WEP key is a set of hexadecimal (hex) or ASCII characters used to encrypt data. This parameter is only available when using WEP **SECURITY MODE** and **ENCRYPTION**. Be sure to record the WEP encryption key so you can retrieve it if necessary.

To create a 64-bit WEP key, enter five normal text characters in the WEP key parameter, which converts the characters automatically to 10 hex digits. Alternatively, enter 10 hex digits (0 to 9, a to f, A to F) directly in the **WEP KEY** parameter.

To create a 128-bit key, enter 13 normal text characters, which convert to 26 hex digits, or enter 26 hex digits (0 to 9, a to f, A to F) directly in the **WEP KEY** parameter.

Note: Clients often support more than one WEP key. Packets received can be decrypted using any one of the keys if programmed, but packets are always transmitted with the default WEP key number. If a transmit key number is set on the RLX2-IHx series radio, make sure all other radios and clients use the same key. To set keys other than key 1 on some clients using Windows, Advanced settings may be used.

Use these steps to program more than one key on the RLX2-IHx series radio.

- 1 Selecting the key number for the **WEP KEY**.
- 2 Enter the actual WEP key
- 3 Save the changes to the radio by clicking **APPLY CHANGES**.
- 4 After the radio restarts, repeat these steps for each WEP key, clicking **APPLY CHANGES** after each one.
- 5 Select the desired transmit key number if necessary and save again (If **** appears in the WEP Key parameter, the previously programmed key will not be changed when changes are applied).

Enterprise Mode Settings

When you select one of the **ENTERPRISE** modes in the **SECURITY MODE** control in the **WIRELESS SECURITY SETTINGS** group, the webpage automatically displays a set of controls for Enterprise mode parameters. There are two sets of controls:

- The first set is for the RLX2-IHx series radio in Master mode
- The second set is for the RLX2-IHx series radio Repeater or Client mode.

Enterprise mode parameters

In Enterprise mode, the radio authenticator communicates directly with the RADIUS Server while it is relaying 802.1x frames received from an associating note's Supplicant. You must configure the following parameters in the **WIRELESS SECURITY SETTINGS** group on the Master radio in this **SECURITY MODE**:

Parameter	Description
IP Address	Specifies the IP address of the RADIUS server with which the Network Administrator has registered this radio.
UDP Port	Specifies the UDP port number the RADIUS server is using to listen to Radius frames from this radio. The default port number used for the Radius protocol is 1812.
Secret	Specifies the pass phrase that was used when this radio was registered to the RADIUS server. This validates that the Radius frames received on either end are legitimate.

Repeater or Client mode parameters

When in Repeater or Client mode, the RLX2-IHx series radio Supplicant communicates via its Parent radio's authenticator with a RADIUS server. Several different authentication protocols are available and can be set using the following parameters.

Parameter	Description
EAP Method	Specifies the EAP Method, sometimes referred to as the 'outer protocol' defines the mechanism used to create a secure tunnel between the Supplicant and RADIUS server during the first phase of the Authentication sequence. The following EAP methods are supported: EAP-PEAP - EAP method using the Protected Extensible Authentication Protocol EAP-TLS - EAP method based on X.509 certificates that provides for mutual authentication. This is the most secure authentication mechanism available for 802.11. Certificates are required both on the radio and the RADIUS server. The only authentication option available for EAP-TLS is to use TLS for the inner protocol. EAP-TTLS - EAP Tunneled TLS. Similar to EAP-PEAP.

Parameter	Description
Anonymous ID	<p>Specifies the identity request in the first phase of the exchange that is sent in the clear. The identity sent in this first phase can be set to an anonymous identity (for example <i>anon_user</i>) or an anonymous identity at a domain (for example <i>anon@xyz.com</i>). The real identity (<i>username</i>) is sent encrypted after the EAP tunnel is established in the second phase of the radius exchange.</p> <p>Use this parameter if you are concerned about the username being sent in the clear. Your IT department should specify the text for this parameter based on their RADIUS server(s) configuration.</p>
Authentication Method	<p>Specifies the authentication method, sometimes referred to as the inner protocol. This defines the mechanism used to authenticate the Supplicant of the radio with the RADIUS server. The following authentication methods are supported:</p> <p>MS-CHAPv2 - Microsoft's version of the Challenge Handshake Authentication Protocol. This method provides mutual authentication between the Supplicant and the RADIUS server, using a user name and password and challenge text responses.</p> <p>MD5 - Message Digest cryptographic hashing algorithm based on a user name and password.</p> <p>TLS - Certificate-based inner authentication protocol.</p>
User Name	<p>Specifies the user name of the account that is to be authenticated. When using EAP-TLS, this represents the identity of the entity assigned to the device certificate being used.</p>
Password	<p>Specifies the required password when using EAP-PEAP or EAP-TTLS with MS-CHAPv2 or MD5. This is the password of the account corresponding to the USER NAME.</p>
Certificates	<p>Displays the current certificates installed in the radio, and provides controls to upload new certificates into the unit. For more information, see <i>Certificate Management</i> (page 76).</p> <p>Note: The RLX2-IHx series radio does not ship with any certificates installed.</p>

Certificate Management

When using Enterprise-level security, some EAP methods require the use of X.509 certificates that you must upload to the RLX2-IHx series radio. There are two certificate types; a certificate from a 'Certification Authority' used to authenticate the RADIUS server to the radio supplicant, and device or client certificate created by the RADIUS server for the radio. The RLX2-IHx series radio is able to hold one of each certificate type.

- If using EAP-PEAP authentication, you need a CA Certificate (to authenticate the RADIUS server) and a username and password.
- If using EAP-TLS, you need a CA Certificate, a Client Certificate, and Private Key (contained in a single p12 file) to authenticate the client. The p12 file is encrypted and requires a password.
- Your IT person will provide you with the appropriate files that you'll need to load to the RLX2-IHx series Repeater radio.

To configure the RLX2-IHx series Repeater radios with certificates

- 1 Obtain the required certificate files from your IT department.
- 2 Log into your radio. See *Connecting to the Radio Configuration Web Interface* (page 40).
- 3 Click the **BASIC SETTINGS** tab, then in the **WIRELESS SECURITY SETTINGS** group, select the **EAP METHOD**.
- 4 Enter the **USERNAME**.
- 5 Click **CERTIFICATES**. This displays the *Certificate Management* dialog box where you enter the certificate files.

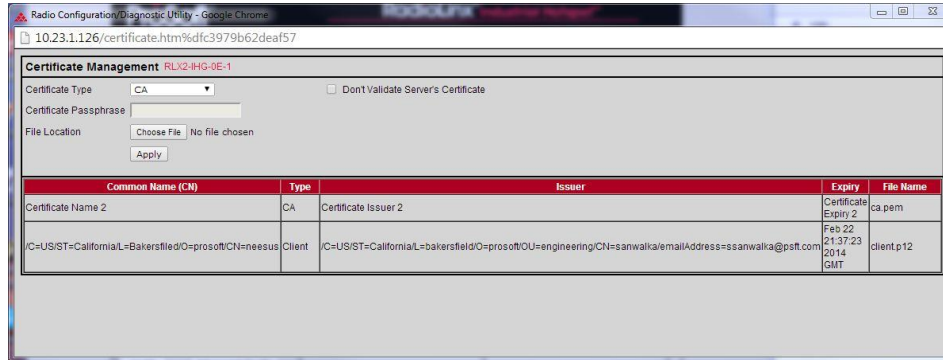

Parameter	Description
Certificate Type	Specifies the type of certificate that you are uploading. It is important that this is set correctly as the RLX2-IHx series radio does not distinguish between certificate types in any other way. A CA Certificate is required for both PEAP and EAP-TLS . This is used to authenticate the server's certificate. Additionally, for EAP-TLS, a client certificate and private key are required.
Certificate Passphrase	If the certificate is encrypted, enter the passphrase that was used to create it on the RADIUS server.
File Location	Selects the certificate file on your local PC that to be uploaded.
Don't Validate Server's Certificate	The radio does not validate the server's certificate.

- 6 Select the **CERTIFICATE TYPE**.
- 7 Click **CHOOSE FILE** to select CA Certificate file created previously (CAcert.pem) and click **APPLY**.
- 8 Click **CHOOSE FILE** to select the Client Certificate combined file (clientcert.p12) and the password associated with the file, and then click **APPLY**.
- 9 Close the *Certificate Management* dialog box.
- 10 In the main window, click **APPLY CHANGES** and attempt to connect to the Master radio.

4.3.3 Access Settings

You use the parameters in the **ACCESS SETTINGS** group to define how your RLX2-IHx series radio gets an IP address.

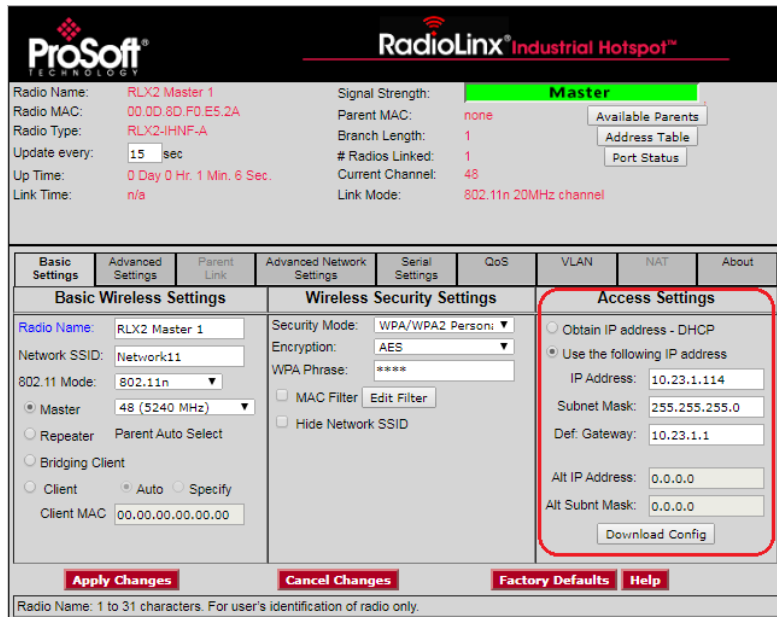

Note: Different versions of the RLX2-IHx series radios and firmware support different functions. There may be fewer or more parameters on this page, depending on the version of the radio and firmware.

Parameter	Description
Obtain IP Address -DHCP	Select this if the radio is to automatically get an IP address through DHCP
Use the following IP address	Select this to manually define IP address for the radio. You must also enter the IP address information in the remaining parameters.
IP Address	Specifies the unique IP address assigned to the module
Netmask	Specifies the subnet mask of module
Def. Gateway	Specifies the network gateway (if used)
Alt IP Address	Specifies a 2 nd IP Address for the module to be used with VLANs
Alt Subnet Mask	Specifies the subnet mask for the 2 nd IP Address

To assign the IP address for your radio

- 1 On the **BASIC SETTINGS** tab, in the **ACCESS SETTINGS** group, click **OBTAIN IP ADDRESS - DHCP** or **USE THE FOLLOWING IP ADDRESS**.
- 2 If you selected **USE THE FOLLOWING IP ADDRESS**, enter the information for the IP address.
- 3 Click **APPLY CHANGES** to reboot the Radio.

4.4 Configuring Advanced Settings

It is important to allow many industrial protocols to communicate properly over the RLX2-IHx series radios. The standard 802.11 AP operation for transmitting broadcast messages is to accumulate them and transmit them on specific time intervals. This allows clients that are in power-save mode to wake up at the synchronized time interval and receive the broadcast packets. However, the power-save mode is rarely used in industrial networks.

Additionally, many industrial protocols utilize multicast traffic, which is sent as broadcast messages over the wireless network. By enabling immediate broadcasting, these multicast messages are not delayed by waiting for the next time interval to occur. This results in improved network performance.

The settings allow you to configure the transmission rate and broadcast mode to optimize this radio's use on an industrial network.

Advanced settings include:

- **ADVANCED WIRELESS SETTINGS**
- **ROAM CONTROL**
- **LOCATION SERVICES**
- **PERSONALITY MODULE**
- **CHANGE PASSWORD**

The screenshot displays the configuration interface for a ProSoft RadioLinx Industrial Hotspot. The interface is divided into several sections:

- Radio Information:** Radio Name: RLX2Repeater, Radio MAC: 00.0D.8D.F0.E5.2A, Radio Type: RLX2-IHNF-A, Update every: 300 sec, Up Time: 0 Day 1 Hr. 14 Min. 11 Sec., Link Time: n/a.
- Signal and Network Info:** Signal Strength: Scanning..., Parent MAC: none, Branch Length: n/a, # Radios Linked: 0, Current Channel: 112, Link Mode: none.
- Navigation Tabs:** Basic Settings, **Advanced Settings**, Parent Link, Advanced Network Settings, Serial Settings, QoS, VLAN, NAT, About.
- Advanced Wireless Settings:** Supported RF Rates (Mbit/s), Max-Min Data Rate (MCS15 - MCS0), Max Basic Rate (24(default)), Optimize For (RLX2 Bridging), Immediate Bcasts (No/Yes), Ignore Probes (No/Yes), Prosoft-only Clients (Off/On), Range (km) (Short/Long 25), uAPSD Support (Off/On), TX Attenuation (0 dBm), Active Antennas (A, B, C), TX Stale Time (60000 msec).
- Roam Control:** Disable FT, Disable Blackout, Parameters Advertised To Children (None), Next Parent (None), Roam Threshold (-40 dBm), Parent Margin (8 dB).
- Location Services:** AeroScout (Disabled).
- Personality Module:** SD Auto Write Enable (checked), SD Auto Clone Enable (checked), Write SD Card button.
- Change Password:** Old, New, Repeat, Timeout (300 sec).
- Buttons:** Apply Changes, Cancel Changes, Factory Defaults, Help.
- Footer:** Factory Defaults: Reset ALL radio parameters to defaults (not just ones on this page).

4.4.1 Advanced Wireless Settings

You use the parameters in the **ADVANCED WIRELESS SETTINGS** group to specify the wireless communication parameters of your RLX2-IHx series radio.

The screenshot displays the configuration interface for a ProSoft RadioLinx Industrial Hotspot. The top section shows the radio's status, including its name (RLX2Repeater), MAC address (00.0D.8D.F0.E5.2A), and signal strength (Scanning...). Below this is a navigation bar with tabs for Basic Settings, **Advanced Settings**, Parent Link, Advanced Network Settings, Serial Settings, QoS, VLAN, NAT, and About. The main configuration area is divided into three sections: **Advanced Wireless Settings** (highlighted with a red box), **Roam Control**, and **Personality Module**. The **Advanced Wireless Settings** section includes options for supported RF rates (MCS15 to MCS0), max basic rate (24), optimization for RLX2 Bridging, immediate broadcasts (No/Yes), ignore probes (No/Yes), prosoft-only clients (Off/On), range (Short/Long), uAPSD support (Off/On), TX attenuation (0 dBm), active antennas (A, B, C), and TX stale time (60000 msec). The **Roam Control** section includes options to disable FT and blackout, parameters advertised to children (None, Next Parent, Roam Threshold, Parent Margin), and location services (AeroScout Disabled). The **Personality Module** section includes options for SD Auto Write Enable and SD Auto Clone Enable, a **Write SD Card** button, and a **Change Password** section with fields for Old, New, Repeat, and Timeout (300 sec). At the bottom, there are buttons for **Apply Changes**, **Cancel Changes**, **Factory Defaults**, and **Help**. A note at the bottom states: "Factory Defaults: Reset ALL radio parameters to defaults (not just ones on this page)."

Note: Different versions of the RLX2-IHx series radios and firmware support different functions. There may be fewer or more parameters on this page, depending on the version of the radio and firmware.

It's important to allow many industrial protocols to communicate properly over the RLX2-IHx radios.

The standard 802.11 AP operation for transmitting broadcast messages is to accumulate them and then transmit them only on specific time intervals. This allows clients in power-save mode to wake up at the specified time interval and receive the broadcast packets.

However, power-save mode is rarely used in industrial networks. Additionally, many industrial protocols use multicast traffic which is sent as broadcast messages over the wireless network.

By enabling immediate broadcasting, these multicast messages are not delayed by the wait for the next time interval to occur before they are transmitted. This results in improved network performance.

The settings on this form also allow you to configure the transmission rate and broadcast mode to optimize the radio's use of an industrial network.

Parameter	Description
Min-Max Data Rate	<p>The maximum and minimum data transmission rates, advertised by this radio in its Beacon. All wireless devices connected to this unit will limit their Tx Rate to values in this range. Available settings range from 1 to 54 when in 802.11ag mode, MCS0 to MCS7 when in 802.11n mode with only 1 antenna (1 stream rates) and MCS0 to MCS15 when in 802.11n mode with 2 or 3 antennas (2 stream rates).</p> <p>Note that only the 2 stream rates that are part of the radios 'rate set' will be included. The radio gives preference to a 1 stream rate over a 2 stream rate when the bit rates are similar.</p>
Max Basic Rate	<p>The maximum Basic transmission rate, advertised by this radio in its Beacon. Basic Rates are used for packets such as Broadcasts that need to go to the whole network and for Management frames. The Max Basic Rate setting of the Master is advertised to each of the radios in the network through Beacons. Each radio, other than the Master, then inherits the Max Basic Rate setting of the Master. Therefore the setting only needs to be made in the Master radio. The setting in each of the other radios is disregarded. Available settings range from 1 to 54 Mb/s.</p>
Optimize For	<p>This control allows ease of configuration for the following controls, for three specific interoperability scenarios.</p> <ul style="list-style-type: none"> ▪ 3RD PARTY CLIENTS - optimizes these controls for providing an infrastructure for peer devices such as laptops, tablets, phones or any other wifi devices that perform regular power saving. If this setting is not used, then these client devices may have difficulty in finding the network's SSID, and their communication may be erratic due to broadcasts not being transmitted when expected. RLX2-IHx bridging will still function, although the RLX2s will be responding to all scanning client devices which may introduce some jitter to data being transferred. ▪ RLX2 BRIDGING - optimizes Immediate Broadcasts, Ignore Probes and Range for operation when peer devices are primarily other RLX2s. ▪ SECURE BRIDGING - is similar to RLX2-IHx Bridging but in addition enables the ProSoft-only Clients control which rejects any connections from 3rd-party client devices.
Immediate Bcasts	<p>Specifies that the radio forwards multicast traffic immediately, rather than waiting for specific time intervals.</p>
Ignore Probes	<p>If set to No will respond to all Probe Requests that are received. If set to Yes will only respond to probe requests that are specific to the radio's SSID and will ignore all general probes.</p>
ProSoft-only Clients	<p>If set to Off will allow all 802.11 devices that have the correct security keys to connect to this Bridge. If set to On, will reject all connections from 3rd-party non-ProSoft wireless devices.</p>
Range (km)	<p>The Range setting allows the radios to account for round trip delays. The Range settings should be the same in all radios in the network and should be at least large enough to account for the length of any links. However, increasing the Range beyond what is necessary can cause a slight decrease in throughput.</p>

Parameter	Description
uAPSD Support	This determines whether uAPSD support (Unscheduled Automatic Power Save Delivery) is advertised in this unit's Beacons. When set to Off, client devices connecting to this unit will not attempt to use uAPSD. When set to On, client devices will use uAPSD if they support it, otherwise they will use normal 802.11 power saving. uAPSD support is On by default. Typically this would only be set to Off if the client device's implementation of uAPSD is not optimal and performance suffers when it attempts to use it. In these cases response of the client device is often better when normal power saving is used.
TX Attenuation	This determines the amount of attenuation that will be applied to the output power of the radio. Mainly used when high gain antennas are used that would exceed the max Tx power allowed by the local regulatory body for the region the RLX2 will be installed
Active Antennas	This determines which of the RLX2's antenna ports are active. This control must be set to match the number of antennas that are actually installed. Note that 2 or more antennas are needed in order to achieve 2 stream (MCS8-15) data rates. When only 2 antennas are installed they should use antenna Ports A and C.
Tx Stale Time	<p>Packets queued for transmission will be discarded if they have not been transmitted in the time set by this control. The main purpose of this control is to limit the duration of any congestion peaks that may occur on a channel that has high utilization. In industrial networks most data packets are time sensitive and if they do not arrive by a certain time are treated as if they were lost. Transmitting these packets after such a timeout would serve no purpose and simply adds load to the radio channel.</p> <p>On a busy channel any burst of interference or sudden unwanted load, such as a burst of broadcast traffic, may lead to large Tx latency times if the channel becomes saturated. Continuing to transmit stale data packets prolongs this condition even though the packets have already been treated as if lost by their destination. The default of this control is also the max value of 60,000 msec. The minimum allowed is 10 msec. This control should only be modified from its default if the packet load in aggregate on a channel is close to saturating the channel, and set to a value that is greater than the max timeout value for any application connection.</p>

802.11n Data Rates

MCS Index	Active Antennas	802.11n mode, Mbit/s		802.11n wide mode, Mbit/s	
		800 ns GI	400 ns GI	800 ns GI	400 ns GI
0	1, 2 or 3	6.50	7.20	13.50	15.00
1	1, 2 or 3	13.00	14.40	27.00	30.00
2	1, 2 or 3	19.50	21.70	40.50	45.00
3	1, 2 or 3	26.00	28.90	54.00	60.00
4	1, 2 or 3	39.00	43.30	81.00	90.00
5	1, 2 or 3	52.00	57.80	108.00	120.00
6	1, 2 or 3	58.50	65.00	121.50	135.00
7	1, 2 or 3	65.00	72.20	135.00	150.00
8	2 or 3	13.00	14.40	27.00	30.00
9	2 or 3	26.00	28.90	54.00	60.00
10	2 or 3	39.00	43.30	81.00	90.00
11	2 or 3	52.00	57.80	108.00	120.00
12	2 or 3	78.00	86.70	162.00	180.00
13	2 or 3	104.00	115.60	216.00	240.00
14	2 or 3	117.00	130.00	243.00	270.00
15	2 or 3	130.00	144.40	270.00	300.00

The radio automatically selects the Guard Interval (GI) based on current operating conditions. The system attempts to use a 400 microsecond GI, but will fall back to an 800 microsecond GI if excessive data corruption is detected. The radio will periodically attempt to resume using a 400 microsecond GI as conditions improve. A 400 microsecond GI results in about 11% more throughput than using an 800 microsecond GI. The user has no control of the GI.

For **RLX2-IHW/A/G** and when the **RLX2-IHNF** is in 802.11a/g mode: **ADVANCED WIRELESS SETTINGS** includes these **DATA RATES** (see following image).

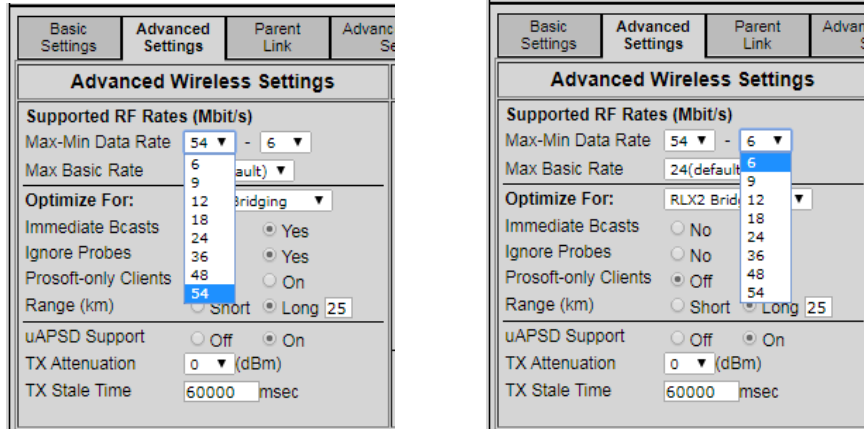

Active Antennas: RLX-IHNF

There are three options for the **ACTIVE ANTENNAS** parameter.

- **A, B, C** (the default setting; use for a three connector MIMO antenna).
- **A ONLY** for one antenna
- **A, C** for two antennas. Note that if two antennas are used, they must be attached to the ANT A and ANT C antenna connectors

MIMO antennas generally have three connections so all three antenna ports must be activated. In general, using three antenna ports gives the best performance. When more than one antenna port is active, the radio monitors the signal appearing at all antenna ports and dynamically select the port(s) with the best signal. However, there are situations where performance may improve if fewer antenna ports are active. If radios are very close together (typically a few feet), all three antenna ports will receive essentially identical signal strengths and the radio may continuously change antenna ports, resulting in degraded performance.

Active Antennas: RLX2-IHW

There are three options for the **ACTIVE ANTENNAS** parameter.

- **1** (one antenna, default setting). Use the main connector labeled *Antenna*.
- **2** (two antennas). If you want to improve performance in high multipath environments through RX diversity, you can add a second antenna to the connector labeled *Rx Only* and set **ACTIVE ANTENNA** to 2 Antennas.

Active Antennas: RLX2-IHA/G

These models only have one antenna port and therefore the Active Antenna control is not shown on the web interface for those models. (see previous image).

4.4.2 Roam Control Settings

You use the parameters in the **ROAM CONTROL** group to specify the roaming wireless communication parameters of a RLX2-IHx series Repeater radio.

The screenshot shows the configuration interface for a RadioLinX Industrial Hotspot. The top section displays radio information: Radio Name (RLX2Repeater), Radio MAC (00.0D.8D.F0.E5.2A), Radio Type (RLX2-IHNF-A), Update every (300 sec), Up Time (0 Day 1 Hr. 14 Min. 11 Sec.), Link Time (n/a), Signal Strength (Scanning...), Parent MAC (none), Branch Length (n/a), # Radios Linked (0), Current Channel (112), and Link Mode (none). Below this is a navigation menu with tabs for Basic Settings, Advanced Settings, Parent Link, Advanced Network Settings, Serial Settings, QoS, VLAN, NAT, and About. The main configuration area is divided into three sections: Advanced Wireless Settings, Roam Control (highlighted with a red box), and Personality Module. The Roam Control section includes checkboxes for 'Disable FT' and 'Disable Blackout', a 'Parameters Advertised To Children' section with options for 'None', 'Next Parent', 'Roam Threshold' (set to -40 dBm), and 'Parent Margin' (set to 8 dB), and a 'Location Services' section with 'AeroScout' set to 'Disabled'. The Personality Module section includes 'SD Auto Write Enable' and 'SD Auto Clone Enable' (both checked), a 'Write SD Card' button, and a 'Change Password' section with fields for Old, New, Repeat, and Timeout (300 sec). At the bottom, there are buttons for 'Apply Changes', 'Cancel Changes', 'Factory Defaults', and 'Help'. A footer note states: 'Factory Defaults: Reset ALL radio parameters to defaults (not just ones on this page).'

Note: Different versions of the RLX2-IHx series radios and firmware support different functions. There may be fewer or more parameters on this page.

In roaming applications, a mobile platform equipped with an RLX2-IHx series Repeater radio roams from one Master radio's coverage area to another radio's coverage area. By default, a Repeater radio roams automatically by calculating the cost for each roam candidate based only on RSSI and hop count. A lower cost determines when a better Parent radio candidate is present.

The RLX2-IHx series radio uses parts of the Fast Transition (FT) standard to reduce the time it takes to roam. An FT Roam will be used if the Repeater radio, the current Parent radio, and the next Parent radio all have FT enabled. You can disable **FT ROAMING**, which results in normal non-FT Roaming.

Independent to the type of Roaming, there are several limitations when the RLX2-IHx series radios are operating in autonomous roam mode that you can overcome by using Parent Assisted Roaming.

Given that the current RLX2-IHx series radio only has one radio module, all Master radios, by necessity, have to be on the same channel to allow the roaming Repeater radios to detect them.

In applications where the mobile platform is traveling a known path, it is necessary to have an unambiguous option when it reaches a roam point. If multiple Parent radios are in range at the roam point, the radio may choose to roam to the wrong Parent radio.

The Repeater radio uses the **ROAM THRESHOLD** and **PARENT MARGIN** parameters for every roam. Due to topology variances, there may be one or two coverage areas that would operate better with different settings for these roam parameters.

The following settings allow for Parent Assisted roaming by advertising these parameter values to any Child Repeater radio that associates to this unit. You can enable each parameter separately. Only enabled parameters are advertised to Child Repeater radios.

Parameter	Description
Disable FT	<p>When checked this disables Fast Transition (FT) roaming in this unit and FT capability is not advertised in this unit's beacons.</p> <p>Note: With FT disabled, the roam duration could double and roams are no longer 'hitless' as there may be some frame loss in the Parent-to-Child direction.</p> <p>FT should be enabled other than a few exceptional circumstances. For example, if a 3rd party client device will not associate to this unit because FT is enabled, or if the RSSI to the Parent is so low at a roam point that FT frames are lost during the roam.</p>
Disable Blackout	<p>When a Repeater's Parent Link is broken due to Sync Loss or if the initial connection fails for any reason a Blackout time is set to a Parent candidate so that the Parent selection algorithm will be forced to try another Parent even if its inferior. This works well when there are always other decent Parent candidates available. In some applications the physical setup is such that all other candidates in some locations are so weak, that any connection to them will be unusable. When it is known that there might only be one valid Parent candidate at times, this control when checked in the Repeater will allow the Parent selection algorithm to ignore any Blackout time that's been set to a Parent and allow an immediate reconnection attempt and prevent a lengthy connection outage. This control is disabled when in Master mode.</p>
None	<p>Select this box to negate all other parameters so that no roam parameters are advertised to Child Repeater radios.</p>
Next Parent	<p>Select this box to advertise the unit that a Child Repeater radio should roam to next. The select box automatically populates with all the RLX2-IHx series units with the same SSID that are on the same Ethernet network as a unit.</p> <p>Each entry is represented by the Name of the RLX2-IHx series radio, so it is important that you give each radio a unique name. If the desired next Parent radio has not been detected because it is not currently powered up or attached to the network, it does not appear in the list. In this case, you can manually enter its MAC Address into the parameter. Once saved, this MAC Address appears in the select box until that unit is detected on the Ethernet, at which time the radio's name replaces the MAC Address.</p> <p>When an advertised NEXT PARENT radio is on the same channel as the current unit, the Child Repeater radio roams to the Next Parent radio when the Next Parent radio's cost is lower than its current Parent radio. When the advertised Next Parent radio is on a different channel, the radio uses the ROAM THRESHOLD to make the roam decision.</p>
Roam Threshold	<p>Select this box to advertise the ROAM THRESHOLD that a Child Repeater radio uses. This Roam Threshold overrides the Child Repeater radio's equivalent setting, only when the Child Repeater radio is associated to this unit. If the Parent radio is not advertising a Roam Threshold, the Child Repeater radio reverts to using its own value configured on the PARENT LINK tab for the Child Repeater radio.</p> <p>This parameter is critical when a Next Parent is also being advertised and that Parent is configured to be on a different channel than this unit. The Child Repeater uses this threshold to determine when to switch to the Next Parent's channel and associate with it.</p>

	<p>You must ensure that at a point where the current Parent's RSSI goes below the threshold, the Next Parent is in range. Otherwise, the roam fails.</p> <p>The main point to remember is that a Child Repeater does not roam while its current Parent's RSSI is higher than the current Roam Threshold value. In the case where a Next Parent radio is not being advertised or the Next Parent radio is on the same channel, then the cost comparison to determine when to roam only occurs when the current Parent's RSSI is below the Roam Threshold. This allows the roam point to be controlled when a mobile platform travels a known path.</p>
Parent Margin	<p>Select this box to advertise the PARENT MARGIN that a Child Repeater radio uses. This Parent Margin overrides the Child Repeater radio's equivalent setting, but only while the Child Repeater radio is associated to this unit. If the Parent radio is not advertising a Parent Margin, the Child Repeater radio reverts to using its own configured value. See <i>Configuring Parent Link Settings</i> (page 92).</p>

4.4.3 Location Services Settings

You use the parameters in the **LOCATION SERVICES** group to enable and disable support for the AeroScout™ Location Services of a RLX2-IHx series Repeater radio. If not present, the feature was disabled at the factory.

The screenshot shows the configuration page for a RadioLinx Industrial Hotspot. At the top, it displays the ProSoft Technology logo and the device name 'RadioLinx Industrial Hotspot™'. Below this, there are fields for Radio Name (RLX2Repeater), Radio MAC (00.0D.8D.F0.E5.2A), Radio Type (RLX2-IHNF-A), Update every (300 sec), Up Time (0 Day 1 Hr. 14 Min. 11 Sec.), Link Time (n/a), Signal Strength (Scanning...), Parent MAC (none), Branch Length (n/a), # Radios Linked (0), Current Channel (112), and Link Mode (none). There are buttons for 'Available Parents', 'Address Table', and 'Port Status'. A navigation bar includes tabs for Basic Settings, Advanced Settings, Parent Link, Advanced Network Settings, Serial Settings, QoS, VLAN, NAT, and About. The main configuration area is divided into three sections: Advanced Wireless Settings, Roam Control, and Personality Module. The 'Location Services' section is highlighted with a red box and contains a dropdown menu for 'AeroScout' currently set to 'Disabled'. Other sections include 'Supported RF Rates', 'Optimize For', 'Immediate Bcasts', 'Ignore Probes', 'Prossoft-only Clients', 'Range (km)', 'uAPSD Support', 'TX Attenuation', 'Active Antennas', 'TX State Time', 'Roam Control' options like 'Disable FT', 'Disable Blackout', 'Parameters Advertised To Children', 'Roam Threshold', and 'Parent Margin', 'Personality Module' options like 'SD Auto Write Enable' and 'SD Auto Clone Enable', and a 'Change Password' section. At the bottom, there are buttons for 'Apply Changes', 'Cancel Changes', 'Factory Defaults', and 'Help', along with a note: 'Factory Defaults: Reset ALL radio parameters to defaults (not just ones on this page)'.

The AeroScout service listens on Port 1141 for commands from the AeroScout engine.

Parameter	Description
AeroScout	Specifies the state of the AeroScout service. <ul style="list-style-type: none"> ▪ DISABLED - Disables the AeroScout service. ▪ TAG ENABLED MODE - Forwards any Tag Reports received by the radio to the AeroScout location engine. ▪ TAG AND MU ENABLED - Forwards Tag Reports and any mobile unit packets heard from on the RLX2-IHx series radio's channel.

4.4.4 Personality Module Settings

You use the parameters in the **PERSONALITY MODULE** group to enable and disable the use of the microSD card (Personality Module) feature of a RLX2-IHx series Repeater radio. You can use the microSD card to save the radio's configuration. This makes it easy to replace the radio with a new radio by moving the microSD card from the old radio to the replacement radio. See *Replacing an Existing Radio* (page 53).

The screenshot shows the configuration interface for a ProSoft RadioLinx Industrial Hotspot. The interface is divided into several sections:

- Radio Information:** Radio Name: RLX2Repeater, Radio MAC: 00.0D.8D.F0.E5.2A, Radio Type: RLX2-IHNF-A, Update every: 300 sec, Up Time: 0 Day 1 Hr. 14 Min. 11 Sec., Link Time: n/a.
- Signal and Linking:** Signal Strength: Scanning..., Parent MAC: none, Branch Length: n/a, # Radios Linked: 0, Current Channel: 112, Link Mode: none.
- Navigation Tabs:** Basic Settings, **Advanced Settings**, Parent Link, Advanced Network Settings, Serial Settings, QoS, VLAN, NAT, About.
- Advanced Wireless Settings:** Supported RF Rates (Mbit/s), Max-Min Data Rate (MCS15 - MCS0), Max Basic Rate (24(default)), Optimize For (RLX2 Bridging), Immediate Bcasts (No/Yes), Ignore Probes (No/Yes), Prosoft-only Clients (Off/On), Range (km) (Short/Long 25), uAPSD Support (Off/On), TX Attenuation (0 dBm), Active Antennas (A, B, C), TX Stale Time (60000 msec).
- Roam Control:** Disable FT, Disable Blackout, Parameters Advertised To Children (None selected), Next Parent (None), Roam Threshold (-40 dBm), Parent Margin (8 dB).
- Personality Module (highlighted):** Personality Module, SD Auto Write Enable (checked), SD Auto Clone Enable (checked), **Write SD Card** button.
- Change Password:** Old, New, Repeat, Timeout (300 sec).
- Location Services:** AeroScout (Disabled).
- Buttons:** Apply Changes, Cancel Changes, Factory Defaults, Help.
- Footer:** Factory Defaults: Reset ALL radio parameters to defaults (not just ones on this page).

Note: The configuration files on the microSD card are stored in a binary format so sensitive data (e.g. passwords, encryption keys) cannot be easily read from the files.

Parameter	Description
SD Auto Write Enable	Select this check box to have the radio write a copy of its configuration to the microSD card whenever new settings are saved from the web configuration interface. The radio renames previous radio configuration files with a unique file name that allows you to audit changes made to the radio's configuration.
SD Auto Clone Enable	Select this check box to have the radio use the configuration from the microSD card when the radio powers up. <ul style="list-style-type: none"> ▪ If a microSD card is present and has a configuration file that is different from the radio's current configuration, the radio uses the configuration from the SD Card. ▪ If the configuration on the micro SD card matches the radio's configuration, or there is no configuration file on the SD Card, then no action is taken. ▪ If you insert a microSD Card into a running radio, and if the configuration file on the SD Card is different from the radio's current configuration, the radio warns you by flashing the Signal Strength, MOD and NET LEDs. If you reboot the radio or cycle power to the radio, it uses the configuration from the microSD card. If you want to save this control as enabled (checked), either the SD card slot in the radio must be empty, or you must enable the SD AUTO WRITE ENABLE control before saving. If these conditions are not present, the software disables this control before saving. This prevents the unit from unintentionally reverting back to a configuration file on the SD Card after resetting. <ul style="list-style-type: none"> ▪ To use the configuration file on an SD card when this control is already enabled, insert the SD card and cycle power to the radio. ▪ If this control is not enabled, enable and save the setting without the SD card inserted (click APPLY CHANGES), then insert the SD card, and then cycle power to the radio. <p>Note: Do not enable SD AUTO WRITE ENABLE if you do not want the active configuration file on the SD card to be replaced when the unit loads and saves the SD card's current configuration file.</p>
Write SD Card	Immediately writes a copy of the unit's configuration file to the SD card, independent of the SD AUTO WRITE ENABLE setting.

4.4.5 Changing Password Settings

You use the parameters in the **CHANGE PASSWORD** group to change the radio password used to access the RLX2-IHx series radio.

The screenshot shows the configuration interface for a ProSoft RadioLinx Industrial Hotspot. The top section displays radio status information such as Radio Name (RLX2Repeater), Radio MAC (00.0D.8D.F0.E5.2A), and Signal Strength (Scanning...). Below this is a navigation bar with tabs for Basic Settings, Advanced Settings, Parent Link, Advanced Network Settings, Serial Settings, QoS, VLAN, NAT, and About. The main configuration area is divided into three columns: Advanced Wireless Settings, Roam Control, and Personality Module. The 'Change Password' section, located in the Personality Module column, is highlighted with a red box and contains the following fields: Old (text input), New (text input), Repeat (text input), and Timeout (300 sec). At the bottom of the interface are buttons for Apply Changes, Cancel Changes, Factory Defaults, and Help. A note at the very bottom states: 'Factory Defaults: Reset ALL radio parameters to defaults (not just ones on this page).'

To change the password

- 1 Enter the old password in **OLD**.
- 2 Enter the new password in **NEW**.
- 3 Enter the new password again in **REPEAT**.
- 4 Click **APPLY CHANGES**.

The **TIMEOUT** parameter sets the time before a login session is terminated at the radio's web server.

Note: Changing tabs and editing fields does not refresh this timer as those changes are local to the web browser. The radio only restarts the login session timer if a webpage is refreshed, or the top info pane updates its information, or an Apply Changes is done.

The **Update every** field defaults to the same value as the **Timeout** control. To keep the login session active change the Update value to something smaller. See *Viewing Radio Status* (page 63).

4.5 Configuring Parent Link Settings

You use the **PARENT LINK** tab to specify how a RLX2-IHx series Repeater, Bridging Client, or Client radio connects to the network. Parent Link includes two groups:

- **PARENT SELECTION METHOD**
- **REPEAT PARAMETERS**

ProSoft TECHNOLOGY **RadioLinx** Industrial Hotspot™

Radio Name: **RLX2 SD CARD** Signal Strength: **Master**
Radio MAC: **00.0D.8D.F0.D3.51** Parent MAC: **none** Available Parents
Radio Type: **RLX2-IHNF-A** Branch Length: **1** Address Table
Update every: **15** sec # Radios Linked: **0** Port Status
Up Time: **0 Day 1 Hr. 48 Min. 26 Sec.** Current Channel: **48**
Link Time: **n/a** Link Mode: **802.11n 20MHz channel**

Basic Settings | **Advanced Settings** | **Parent Link** | Advanced Network Settings | Serial Settings | QoS | VLAN | NAT | About

Parent Selection Method | **Repeater Parameters**

Automatically Choose Best
 Parent Branch Length **▼**
 Preferred Parent **▼**

1. 00.00.00.00.00.00	5. 00.00.00.00.00.00
2. 00.00.00.00.00.00	6. 00.00.00.00.00.00
3. 00.00.00.00.00.00	7. 00.00.00.00.00.00
4. 00.00.00.00.00.00	8. 00.00.00.00.00.00

Signal Strength Threshold: **-50**
Default Parent Margin: **5** dB
Rate to Parent: **Auto** Mb/s
Allow Children: Yes No
Optimize Fast Roam Parameters:
Cost Penalty Factor: **8**

Apply Changes **Cancel Changes** **Factory Defaults** **Help**

Indicates whether the unit is operating in N mode and if it is using 40 MHz channels.

4.5.1 Parent Selection Method Settings

You use the parameters in the **PARENT SELECTION METHOD** group to specify how the RLX2-IHx series Repeater radio chooses a Parent radio in a wireless network.

The screenshot shows the configuration page for a RadioLinx Industrial Hotspot. The top section displays system information: Radio Name (RLX2 SD CARD), Radio MAC (00:0D:8D:F0:D3:51), Radio Type (RLX2-IHNF-A), Update every (15 sec), Up Time (0 Day 1 Hr 50 Min 11 Sec), Link Time (n/a), Signal Strength (Master), Parent MAC (none), Branch Length (1), # Radios Linked (0), Current Channel (48), and Link Mode (802.11n 20MHz channel). Below this is a navigation menu with tabs for Basic Settings, Advanced Settings, Parent Link, Advanced Network Settings, Serial Settings, QoS, VLAN, NAT, and About. The 'Parent Link' tab is active, showing the 'Parent Selection Method' section. This section has three radio buttons: 'Automatically Choose Best' (selected), 'Parent Branch Length' (with a dropdown menu), and 'Preferred Parent' (with a dropdown menu). Below these are eight input fields for MAC addresses, arranged in two columns of four. To the right is the 'Repeater Parameters' section, which includes fields for Signal Strength Threshold (-50), Default Parent Margin (5 dB), Rate to Parent (Auto Mb/s), Allow Children (Yes/No), Optimize Fast Roam Parameters (checkbox), and Cost Penalty Factor (8). At the bottom of the configuration area are buttons for 'Apply Changes', 'Cancel Changes', 'Factory Defaults', and 'Help'. A footer note reads: 'Parent Selection Method: Define how to choose parent radio the Repeater links to.'

Parameter	Description
Automatically Choose Best	Calculates a "cost" metric for each possible parent radio that it detects and selects the Parent radio based on the lowest cost. The radio's calculation includes: <ul style="list-style-type: none"> ▪ RSSI - Stronger signals receive a lower cost. ▪ Hop Count - Fewer hops from the Master radio is given preference and therefore a lower cost
Parent Branch Length	Calculates the branch length to other radios and chooses the Parent radio strictly by the number of Repeater radios between this radio and the Master radio. <ul style="list-style-type: none"> ▪ If you choose a branch length of 1, the radio links only to the Master radio. ▪ If you choose a branch length of 2, the radio links only to another RLX2-IHx series radio that is linked to the Master radio, and so on. ▪ If multiple candidate radios are available at a particular hop count, the radio chooses the Parent radio that has the smallest cost as calculated by the Automatically Choose Best algorithm.
Preferred Parent	Specifies how the radio selects a Parent radio from the list of possible Parent radios. When you select this option, you can specify a list of up to eight radios by entering the MAC addresses for each radio. The radio chooses its Parent radio based on your selection for PREFERRED PARENT : BEST IN LIST - The radio selects its Parent radio using the Automatically Choose Best algorithm, but limits the selection to the Preferred Parent list of radios. This selects the Parent radio in the list with the lowest cost. FOLLOW LIST PRIORITY - The radio selects its Parent radio from the list giving preference to the 1st entry followed by the 2nd entry and so on. 2.4 GHZ PARENTS ONLY - The radio only selects a Parent radio from the list that is operating in the 2.4 GHz band. 5 GHZ PARENTS ONLY - The radio only selects a Parent radio from the list that is operating in the 5 GHz band.

4.5.2 Repeater Parameters Settings

You use the parameters in the **REPEAT PARAMETERS** group to specify the wireless communication parameters of a RLX2-IHx series Repeater radio.

The screenshot shows the configuration interface for a ProSoft RadioLinx Industrial Hotspot. The 'Parent Link' tab is selected, displaying two main sections: 'Parent Selection Method' and 'Repeater Parameters'. The 'Repeater Parameters' section is highlighted with a red border and contains the following settings:

- Signal Strength Threshold: -50
- Default Parent Margin: 5 dB
- Rate to Parent: Auto Mb/s
- Allow Children: Yes (selected)
- Optimize Fast Roam Parameters: (checkbox unchecked)
- Cost Penalty Factor: 8

At the bottom of the configuration area, there are buttons for 'Apply Changes', 'Cancel Changes', 'Factory Defaults', and 'Help'. A footer note reads: 'Parent Selection Method: Define how to choose parent radio the Repeater links to.'

Parameter	Description
Signal Strength Threshold	Specifies a signal strength above which a stronger signal does not improve the quality of the link any further. For signals that are above that threshold, the radio only gives preference to Parent radios with fewer hops from the Master radio. Another way to consider this in Fast Roam applications is that the radio does not Roam to a new Parent radio at the same hop count level until its current Parent radio's RSSI goes below (weaker) than this value.

<p>Default Parent Margin</p>	<p>Specifies a signal strength below which the radio will not select a different Parent radio. You can use this in Fast Roam applications where the radio is on a mobile platform, or there is a lot of movement in the environment causing RSSI levels to fluctuate. The radio keeps its current Parent radio unless another Parent radio's RSSI is stronger than this value. The radio adds this margin value to the current Parent radio's RSSI prior to calculating its cost. It is desirable to Roam to a new Parent radio before losing the connection with the current Parent radio, since losing the connection results in data loss.</p> <ul style="list-style-type: none"> ▪ If you enter a value that is too small, it can lead to the radio rapidly switching back and forth between two Parent radios as the RSSI levels change. ▪ If you enter a value that is too large, it can result in preventing a Roam until the radio moves out of range, even though a candidate exists that is actually better than the current Parent radio. <p>The default value is 5 dB.</p> <ul style="list-style-type: none"> ▪ Use larger values (10-15 dB) to prevent false roams from occurring due to temporary RSSI inversions between the current Parent radio and another candidate. ▪ Make sure that that when Roaming that the RSSI difference between the current Parent radio and the new Parent radio is greater than this value.
<p>Rate to Parent</p>	<p>Specifies how the radio selects the rate to the Parent radio.</p> <p>AUTO - The default setting. The radio selects the best rate to use to the Parent radio, and adapt over time.</p> <p>FIXED RATE - Fixes a lower rate to improve performance; for example if the link to the Parent radio has a low signal strength.</p> <p>The actual rate used between this radio and its Parent radio is the lower value of this setting and the Max Data Rate setting in the Parent radio. So use RATE TO PARENT in this radio, and MAX DATA RATE in the Parent radio in conjunction if you want to customize the rate of each parent link. See <i>Advanced Wireless Settings</i> (page 80).</p> <p>Note: When configuring an RLX2-IHNF, this parameter is only enabled if the 802.11 MODE parameter on the BASIC SETTINGS page is set to 802.11A/G mode. See <i>Basic Wireless Settings</i> (page 67).</p>
<p>Allow Children</p>	<p>Specifies whether the Repeater radio acts as a Parent radio to other 802.11 radios.</p> <p>YES - Allows this radio to be a Parent radio to other 802.11 radios.</p> <p>NO - Disguises the radio's SSID to prevent other 802.11 devices from finding it. This is useful in Fast Roam applications where you do not want any other devices connect to a Repeater radio that moving and roaming.</p>

Optimize Fast Roam Parameters	<p>Select this check box to optimize the radio for Fast Roaming. In typical Fast Roam applications a Repeater is installed on a mobile pallet or platform and a set of Master units forms a backbone infrastructure network, through which the Repeater must roam.</p> <ul style="list-style-type: none">▪ Selecting the check box automatically sets these parameters accordingly along with a predetermined optimum value for the cost threshold.▪ Clearing the check box reverts the parameters back to their previous values before the check box state was saved. <p>Repeater radio - The relevant parameters that are automatically set for the Repeater radio are:</p> <ul style="list-style-type: none">▪ Do not allow Child Repeaters (ALLOW CHILDREN).▪ Use a SIGNAL STRENGTH THRESHOLD set high enough so that the radio uses RSSI to determine the link cost to a Parent radio. <p>Master radio - The relevant parameters that you must manually set for the Master radio are:</p> <ul style="list-style-type: none">▪ Clear HIDE NETWORK SSID on the BASIC SETTINGS tab to make the Master radio SSID visible to other devices. See Wireless Security Settings (page 70).▪ Disable SPANNING TREE on the ADVANCED NETWORK SETTINGS tab. See STP Settings (page 101). <p>Note: You must manually disable Spanning Tree and clear Hide Network SSID on all Master units, as this parameter only affects the current Repeater radio.</p> <p>You can change any of these Repeater radio parameters later. For example you can set a different value for the Signal Strength Threshold. Changing any of the related parameters in the Repeater radio clears the Optimize Fast Roam Parameters check box.</p>
-------------------------------	---------------------------------------------------------------------------------------------------------------------------------------------------------------------------------------------------------------------------------------------------------------------------------------------------------------------------------------------------------------------------------------------------------------------------------------------------------------------------------------------------------------------------------------------------------------------------------------------------------------------------------------------------------------------------------------------------------------------------------------------------------------------------------------------------------------------------------------------------------------------------------------------------------------------------------------------------------------------------------------------------------------------------------------------------------------------------------------------------------------------------------------------------------------------------------------------------------------------------------------------------------------------------------------------------------------------------------------------------------------------------------------------------------------------------------------------------------------------------------------------------------------------------------------------------------------------------------------------------------------------------------------------------------------------------------------------------------------------------------------------------------------------------------------------------------------------------------------------------------

4.6 Configuring Advanced Network Settings

You use the **ADVANCED NETWORK SETTINGS** tab to specify the IGMP (Internet Group Management Protocol), STP (Spanning Tree Protocol), SNMP (Simple Network Management Protocol), and Cable Break Detection parameters for a RLX2-IHx series radio. The *Advanced Network Settings* includes five groups:

- **IGMP SETTINGS**
- **OTHER NETWORK PROTOCOLS**
- **STP SETTINGS**
- **SNMP AGENT**
- **CABLE BREAK DETECTION**

ProSoft TECHNOLOGY **RadioLinx Industrial Hotspot™**

Radio Name: **RLX2Master** Signal Strength: **Master**
 Radio MAC: **00.0D.8D.F0.E5.2A** Parent MAC: **none** Available Parents
 Radio Type: **RLX2-IHNF-A** Branch Length: **1** Address Table
 Update every: **300** sec # Radios Linked: **0** Port Status
 Up Time: **0 Day 0 Hr. 42 Min. 16 Sec.** Current Channel: **48**
 Link Time: **n/a** Link Mode: **802.11n 20MHz channel**

Basic Settings	Advanced Settings	Parent Link	Advanced Network Settings	Serial Settings	QoS	VLAN	NAT	About	
			IGMP Settings IGMP Multicast Filtering <input type="radio"/> Disabled <input checked="" type="radio"/> Enabled Default Propagation Action <input checked="" type="radio"/> Flood <input type="radio"/> Filter IGMP Query Generation Timed Interval ▾ IGMP Query Interval 60 seconds Multicast Stale Count 3 query frames <hr/> Other Network Protocols <input type="checkbox"/> PTP Filter <input type="checkbox"/> Arp Proxy <input type="checkbox"/> EIP Obj Dis	STP Settings <input type="checkbox"/> Enable Spanning Tree <input checked="" type="checkbox"/> Ethernet Edge Port Bridge Times Priority 32770 Hello Time 2 s Max Age 20 s Forward Delay 10 s Path Costs Wireless 200 Ethernet 100	SNMP Agent <input checked="" type="checkbox"/> Enable <input checked="" type="radio"/> Allow Any Manager <input type="radio"/> Allow IP 0.0.0.0 Community String public Permission <input checked="" type="radio"/> Read only <input type="radio"/> Read/Write <hr/> Cable Break Detection <input type="checkbox"/> Enable Threshold 10 dB				

Apply Changes **Cancel Changes** **Factory Defaults** **Help**

Enable or disable the multicast filtering mode. If disabled, no other IGMP controls are active.

4.6.1 IGMP Settings

You use the parameters in the **IGMP SETTING** group to specify the Internet Group Management Protocol parameters of your RLX2-IHx series radio.

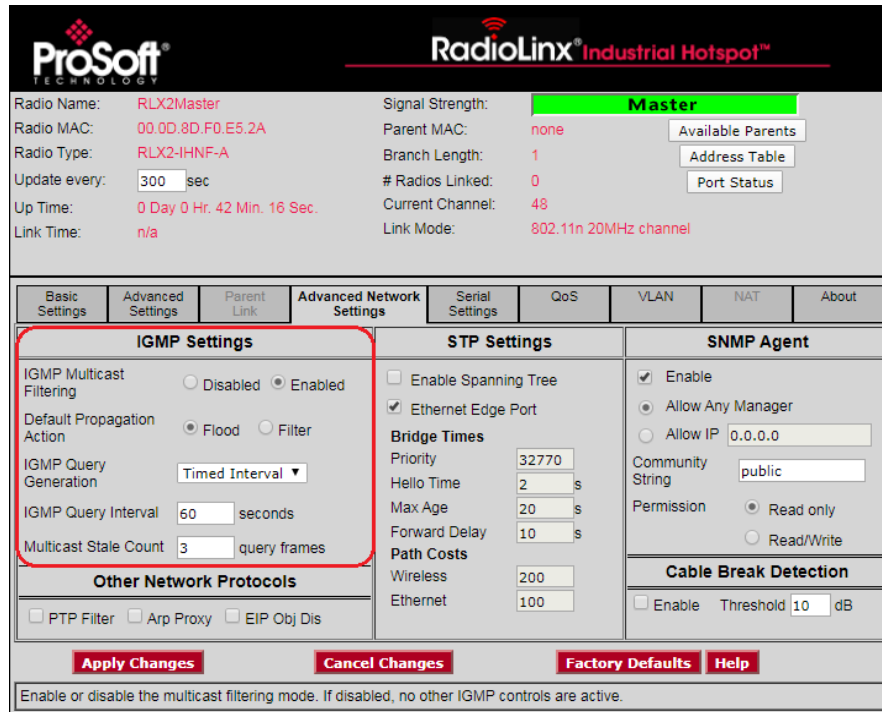

RLX2-IHx series radios support IGMP v1 and v2. The IGMP functions are enabled in the radios by default.

Parameter	Description
IGMP Multicast Filtering	Specifies the state of IGMP multicast filtering (DISABLED or ENABLED).
Default Propagation Action	Specifies how the radio handles multicast addresses that are not in the radio's address table. FLOOD - The radio sends unknown multicast packets to all ports. FILTER - The radio filters unknown multicast packets, and does not send them to any ports.
IGMP Query Generation	Specifies the state of IGMP query generation in the radio. DISABLED - Disables IGMP query generation. TIMED INTERVAL - Enables IGMP query generation. Use IGMP Query Interval to specify the query time interval.
IGMP Query Interval	Specifies the number of seconds between queries (if the timer is not pre-empted by a query from another device). By RFC specification, only one device on a network should generate IGMP queries. As such, the radio only sends an IGMP query if another device has not sent a query within the radio's IGMP QUERY INTERVAL setting, even if IGMP QUERY GENERATION is enabled.
Multicast State Count	Specifies the number of queries the radio generates before a device is removed from the multicast group on this radio if no response is received from the device.

4.6.2 Other Network Protocols

This section contains controls to enable or disable actions taken on PTP or ARP packets received on the RLX2 Ethernet interface.

The screenshot shows the configuration interface for a RadioLinx Industrial Hotspot. The 'Advanced Network Settings' tab is active. The 'Other Network Protocols' section is highlighted with a red box and contains the following options:

- PTP Filter
- Arp Proxy
- EIP Obj Dis

Other visible settings include:

- IGMP Settings:** IGMP Multicast Filtering (Enabled), Default Propagation Action (Flood), IGMP Query Generation (Timed Interval), IGMP Query Interval (60 seconds), Multicast Stale Count (3 query frames).
- STP Settings:** Enable Spanning Tree (unchecked), Ethernet Edge Port (checked), Bridge Times (Priority: 32770, Hello Time: 2s, Max Age: 20s, Forward Delay: 10s), Path Costs (Wireless: 200, Ethernet: 100).
- SNMP Agent:** Enable (checked), Allow Any Manager (selected), Allow IP (0.0.0.0), Community String (public), Permission (Read only).
- Cable Break Detection:** Enable (unchecked), Threshold (10 dB).

Buttons at the bottom include 'Apply Changes', 'Cancel Changes', 'Factory Defaults', and 'Help'. A footer note states: 'Enable or disable the multicast filtering mode. If disabled, no other IGMP controls are active.'

Parameter	Description
PTP Filter	<p>Check this box to enable the PTP Filter feature. The Precision Time Protocol (PTP) is used in industrial networks to synchronize time between devices. Given the protocol uses multicast addressing, a PTP packet sent by one device is sent over every wireless link in that network. PTP is only needed amongst a set of local Ethernet connected units. The injection of PTP packets arriving over a wireless link (connecting this local network to the main network) may cause large errors in time synchronization.</p> <p>To prevent leaking of PTP packets, the following control allows the RLX2-IHx Series to filter any PTP packets received on its Ethernet port. When this capability is desired, this control should be enabled on all Masters and Repeaters in the network</p>

Parameter	Description
Arp Proxy	<p>In industrial wireless networks, it is important to minimize external disturbances which can cause packet latencies to soar. This can be anything from interference generated from other equipment, to another wireless network using the same channel or even internally generated broadcast bursts which when transmitted simultaneously from multiple overlapping Masters can cause severe latency spikes.</p> <p>The latter can sometimes unintentionally be caused by a controller looking for a list of remote devices, producing a burst of ARP Request frames. The ARP Proxy feature when enabled, will intercept these ARP Requests and prevent them from flooding the wireless network. The RLX2 is continually learning and adding the MAC and IP Addresses of devices to its address tables and if the IP Address being requested by the ARP Request is known, the ARP Proxy function will send an ARP Response for the IP Address back to the Requestor.</p> <p>The ARP Proxy feature should not be enabled if it is known that remote devices do not send unsolicited IP frames after power up. If the device remains silent until it is polled for example then the RLX2s will not learn its IP/MAC Address and any ARP Requests for this device will not reach it.</p> <p>In wireless network topologies where Repeaters always connect directly to Masters, the ARP Proxy feature only needs to be enabled on the Masters. If the topology consists of a multi-hop Repeatered network then enabling the ARP Proxy feature on the Repeaters will also prevent ARP Request floods down-tree from the Repeater.</p>
EIP Object Disable	Check this box to disable the Ethernet I/P agent in the radio. When checked queries to read the EIP Object classes are ignored.

4.6.3 STP Settings

You use the parameters in the **STP SETTING** group to specify the Spanning Tree Protocol parameters of your RLX2-IHx series radio.

The screenshot shows the configuration interface for a ProSoft RadioLinx Industrial Hotspot. The top section displays radio information: Radio Name (RLX2Master), Radio MAC (00.0D.8D.F0.E5.2A), Radio Type (RLX2-IHNF-A), Update every (300 sec), Up Time (0 Day 0 Hr. 42 Min. 16 Sec.), Link Time (n/a), Signal Strength (Master), Parent MAC (none), Branch Length (1), # Radios Linked (0), Current Channel (48), and Link Mode (802.11n 20MHz channel). Below this is a navigation menu with tabs for Basic Settings, Advanced Settings, Parent Link, Advanced Network Settings, Serial Settings, QoS, VLAN, NAT, and About. The 'Advanced Network Settings' tab is active, showing three sub-sections: IGMP Settings, STP Settings (highlighted with a red box), and SNMP Agent. The STP Settings section includes:

- Enable Spanning Tree
- Ethernet Edge Port
- Bridge Times**
 - Priority: 32770
 - Hello Time: 2 s
 - Max Age: 20 s
 - Forward Delay: 10 s
- Path Costs**
 - Wireless: 200
 - Ethernet: 100

 The IGMP Settings section includes options for IGMP Multicast Filtering (Disabled/Enabled), Default Propagation Action (Flood/Filter), IGMP Query Generation (Timed Interval), IGMP Query Interval (60 seconds), and Multicast Stale Count (3 query frames). The SNMP Agent section includes options to Enable, Allow Any Manager, Allow IP (0.0.0.0), Community String (public), and Permission (Read only/Read/Write). At the bottom, there are buttons for 'Apply Changes', 'Cancel Changes', 'Factory Defaults', and 'Help'. A footer note states: 'Enable or disable the multicast filtering mode. If disabled, no other IGMP controls are active.'

Parameter	Description
Enable Spanning Tree	<p>Select this check box to enable Spanning Tree Protocol (STP).</p> <ul style="list-style-type: none"> If you enable Spanning Tree (recommended), the radio blocks redundant connections. Additionally, the radio flushes the Ethernet switch table when the network topology changes. See Rapid Spanning Tree Functionality (page 103). If you disable Spanning Tree (clear the check box), there can be redundant connections if the radio creates multiple radio links in parallel with each other. This also disables the other parameters in the STP SETTINGS group. <p>All RLX2-IHx series radios support the Rapid Spanning Tree Protocol (RSTP), and default to this mode when you enable Spanning Tree.</p>

Parameter	Description
Ethernet Edge Port	<p>Select this check box to enable the Ethernet Edge Port function (recommended) when no RSTP device is connected to the Ethernet port. This allows immediate communication through the Ethernet port.</p> <p>Because RSTP is an active protocol, it depends on communication between RSTP devices. If no RSTP device is connected to the radio's Ethernet port, the handshake cannot take place. In this case, RSTP reverts to STP. This means that the Ethernet port is forced to adhere to the timer based transition protocol of STP.</p> <p>Therefore on network transitions and power up, communications are not allowed over the Ethernet port for 30 to 45 seconds unless you enable ETHERNET EDGE PORT. This setting specifies that no redundant connections exist out the Ethernet port and communication can start immediately. If for some reason the radio receives a BPDU (bridge protocol data unit) on this port, the RSTP protocol negotiates properly and handles any possible redundant paths.</p> <p>Note: You can select ETHERNET EDGE PORT without selecting ENABLE SPANNING TREE.</p>
Bridge Times	Configures the timing intervals to use.
Priority	<p>Determines which device is the root of the RSTP. The RSTP device with the lowest priority becomes the root bridge.</p> <ul style="list-style-type: none"> ▪ The accepted standard value for this is 32768. If wired switches exist in the network that support RSTP, they should always be allowed to be the root. ▪ For Master radios, set this value to 32769 to prevent the radio from being the root over a wired switch. ▪ For Repeater radios, set this value to 32770. This specifies that if the network only has RLX2-IHx series radios, the Master radio becomes the root.
Hello Time	Specifies the rate at which the radio sends out BPDUs. The recommended industry standard is 2 seconds.
Max Age	<p>Specifies the age limit for protocol information for a port.</p> <p>The radio measures the age of the received protocol information recorded for a port and discards it when the information's age limit exceeds this value. The timeout value for this timer is the maximum age parameter of the root.</p>
Forward Delay	Specifies the timeout for time spent by a port in the learning and listening states. The timeout value is the forward delay parameter of the root.
Path Costs	RSTP and STP algorithms use a cost to determine which connections should be used in the Spanning Tree. The radio forms the Spanning Tree by determining the lowest cost paths from any RSTP device back to the root.
Wireless	Gives preference to a wired connection, set the Wireless cost to 200 .
Ethernet	Gives preference to a wired Ethernet connection, set the Ethernet cost to 100 .

Rapid Spanning Tree Functionality

Rapid Spanning Tree Protocol (RSTP) is an advanced networking function that shuts off ports as necessary to prevent data packet loops when more than one network path is available. If loops exist in an Ethernet network, the devices can circulate packets endlessly, consuming all the bandwidth and making the network unusable.

RSTP allows the radios to create truly redundant connections between any two points in the network, but use only one path at a time. The radios detect the redundant paths and use only one primary connection for communications. If the primary connection fails, the radios quickly change to the secondary connection to a state to forward packets, allowing the network to adapt itself to handle problems without requiring your intervention.

RTSP uses active communications between network devices to quickly propagate changes and transitions in the network. Because RTSP is an IEEE standard, RLX2-IHx series radios work in conjunction with wired Ethernet switches to form a redundant network.

Each RSTP device (RLX2-IHx series radio or Ethernet switch) communicates with other RSTP devices in the network using packets called Bridge Protocol Data Units (BPDUs). Each device sends BPDUs out each of the devices ports. In a wired switch, this is from each of the Ethernet ports. In an RLX2-IHx series Radio, this is from both the Ethernet port and each wireless link. BPDUs allow each RSTP device in the network to make sure that the proper connections still exist.

The *Port Status* dialog box shows a list of all ports and their state. In the top part of the radio web interface, click **PORT STATUS**. See *Viewing the Radio Port Status* (page 64). In this example, the RLX2-IHx series radio has 4 RSTP "ports":

- Ethernet port (1)
- A port for its parent connection (2)
- A port for each of its two child connections (11 and 12)

#	Connection	State	Designation	Path Cost	Designated Bridge
1	Ethernet-Disconnected	Forwarding	Designated	800	00.05.87.01.00.ED
2	RF Parent: 00.05.87.01.01.14	Forwarding	Root	500	00.05.87.01.01.14
11	RF Child 00.05.37.01.01.5C	Forwarding	Designated	700	00.05.87.01.00.ED
12	RF Child 00.0D.8D.F0.0C.4F	Forwarding	Designated	700	00.05.87.01.00.ED

BPDUs are sent out the port at a rate called the *Hello Time* set on the **ADVANCED NETWORK SETTINGS** tab. The accepted standard value for this parameter is 2 seconds. If a radio (or any other RSTP device) does not get a BPDU from a device for a time period equal to two Hello Times, the radio assumes the RSTP device is no longer available. The radio can then open a redundant path if one is available. This process is much like the STP process. If other devices on the network are not operating in Rapid Spanning Tree mode, the radio reverts to normal Spanning Tree operation on the ports connected to those devices.

RSTP provides a performance enhancement over STP.

- A radio using the STP algorithm reverts its port to the listening state, and then to the learning state, before returning to the forwarding state. Each of these states takes at least 15 seconds, during which the STP devices are listening for BPDUs to re-negotiate the network topology.
- A radio using the RSTP algorithm uses active handshaking between adjacent RSTP devices to re-negotiate the network topology. This process takes only one to two seconds.

Each RLX2-IHx series radio contains a switch table that tells the radio how to forward Ethernet packets to get them to their correct destination. When the network topology changes, the radio immediately flushes its Ethernet switch table. This allows the radio to pass traffic immediately over the new network topology and learn the configuration in the process. Until the radio completely learns the new topology, it broadcasts the packets to their destination. As the radios see each packet and rebuilds the Ethernet switch table, the radios return to directing packets to their destinations.

4.6.4 SNMP Agent

You use the parameters in the **SNMP AGENT** group to specify the Simple Network Management Protocol parameters of your RLX2-IHx series radio.

SNMP is a network management protocol that is often used with TCP/IP and Ethernet. It offers an alternative to using the radio web interface, and allows you to use an SNMP manager application to change radio settings and view diagnostics.

Parameter	Description
Enable	Select this check box to enable the following SNMP agent.
Allow Any Manager	Specifies that any user can change the radio configuration from any computer using SNMP.
Allow IP	Specifies that only an SNMP manager with a particular IP address can change the radio configuration. You must enter the IP address.
Community String	Specifies a <i>community string</i> (similar to a password) that an SNTP manager must use to access the radio's SNMP agent.
Permission	Specifies the permission level to assign to this radio. READ ONLY - The SNMP manager can view, but cannot change the radio configuration. READ/WRITE - The SNMP manager can view and make changes to the radio configuration.

- The RLX2-IHx series radio's SNMP agent supports SNMP protocol version 1.4 and 2.
- MIBs:
 - RFC12133-MIB (partial; internet.mgmt.MIB-2.system, .interfaces, .snmp)
 - ROMAP-MIB (internet.private.enterprises.romap)
- It also supports a selection of standard SNMP traps, including Cold Start, which the radio sends when it initializes.

4.6.5 Cable Break Detection

One common application interconnects a line of RLX2-IHx Masters with Radiating Cable, allowing mobile platforms to move down the line roaming from Master to Master. The radiating cable between the Masters allows them to receive each other's packets, in particular each other's Beacon frames. It is therefore possible for a Master to detect if the Radiating Cable between itself and the next or previous Master is broken or damaged. When enabled, this feature will produce an SNMP Trap whenever it detects an RSSI drop to one of its Monitored Peers.

A cable break is defined as a change in RSSI greater than the Cable Break Threshold. The RLX2-IHx will automatically determine the closest Peers and will adopt a baseline RSSI from each Peer when it is first picked to be monitored.

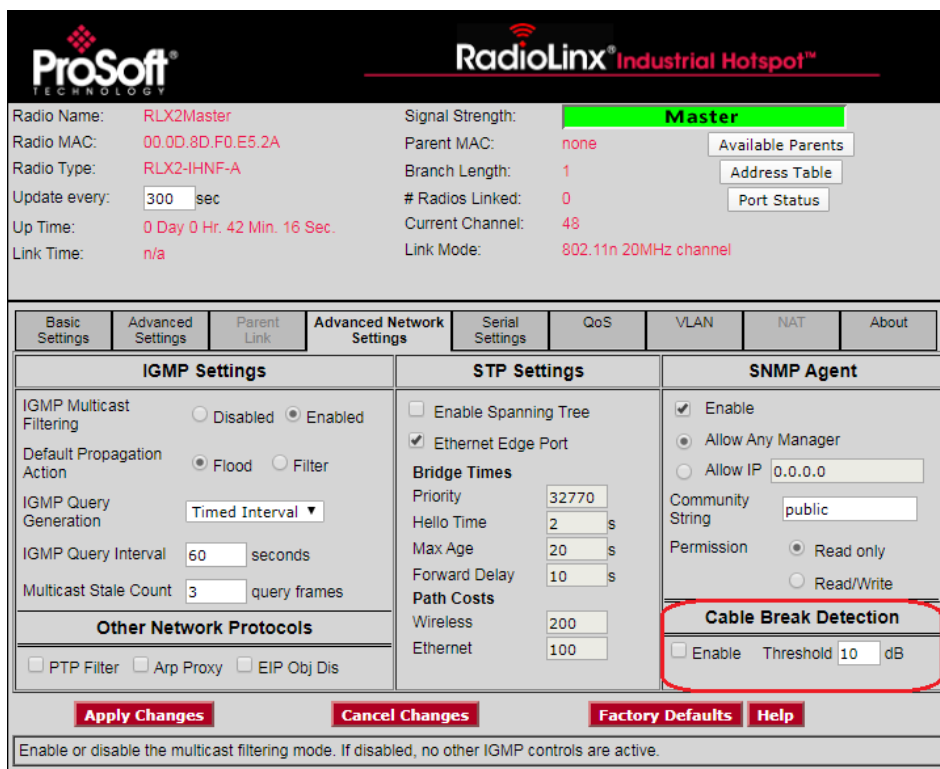

Parameter	Description
Enable	Select this check box to enable the <i>Cable Break Detection</i> feature
Threshold	Configures the RSSI change (in dB) observed while monitoring a neighboring RLX2-IHx Master that will trigger a cable break indication via an SNMP Trap.

4.7 Configuring Serial Settings

You use the **SERIAL SETTINGS** tab to specify the serial communication parameters for a RLX2-IHx series radio. Serial Settings includes four groups:

- **SERIAL ENCAPSULATION MODE**
- **REMOTE IP SETTINGS**
- **PACKET DELINEATION**
- **PORT SETTINGS**

ProSoft TECHNOLOGY **RadioLinx[®] Industrial Hotspot™**

Radio Name: **RLX2 SD CARD** Signal Strength: **Master**
 Radio MAC: **00.0D.8D.F0.D3.51** Parent MAC: **none** Available Parents
 Radio Type: **RLX2-IHNF-A** Branch Length: **1** Address Table
 Update every: **15** sec # Radios Linked: **0** Port Status
 Up Time: **0 Day 2 Hr. 47 Min. 1 Sec.** Current Channel: **48**
 Link Time: **n/a** Link Mode: **802.11n 20MHz channel**

Basic Settings | **Advanced Settings** | Parent Link | Advanced Network Settings | **Serial Settings** | QoS | VLAN | NAT | About

Serial Encapsulation Mode None(default) ▼

Remote IP Settings	Packet Delineation	Port Settings
<input checked="" type="radio"/> Single IP/URL <input type="text" value="0.0.0.0"/> <input type="radio"/> Range of IP Addresses: From To Range 1: <input type="text" value="0.0.0.0"/> <input type="text" value="0.0.0.0"/> Range 2: <input type="text" value="0.0.0.0"/> <input type="text" value="0.0.0.0"/> Range 3: <input type="text" value="0.0.0.0"/> <input type="text" value="0.0.0.0"/> Range 4: <input type="text" value="0.0.0.0"/> <input type="text" value="0.0.0.0"/> Rmt Port <input type="text" value="4002"/> Loc Port <input type="text" value="4002"/>	Delineation Method: None ▼ EOL Delineator: <input type="checkbox"/> CR ▼ EOL Time Gap (ms): <input type="text" value="10"/> Packet Rate (ms): <input type="text" value="10"/>	Baud Rate: 115,200(default) ▼ Data Bits: 8(default) ▼ Parity: None(default) ▼ Flow Cntl: None(default) ▼ Stop Bits: 1(default) ▼

Apply Changes **Cancel Changes** **Factory Defaults** **Help**

Remote connection type for Serial App. to transport serial characters.

4.7.1 Serial Encapsulation Mode Setting

You use the **SERIAL ENCAPSULATION MODE** parameter to specify the serial encapsulation parameter of your RLX2-IHx series radio.

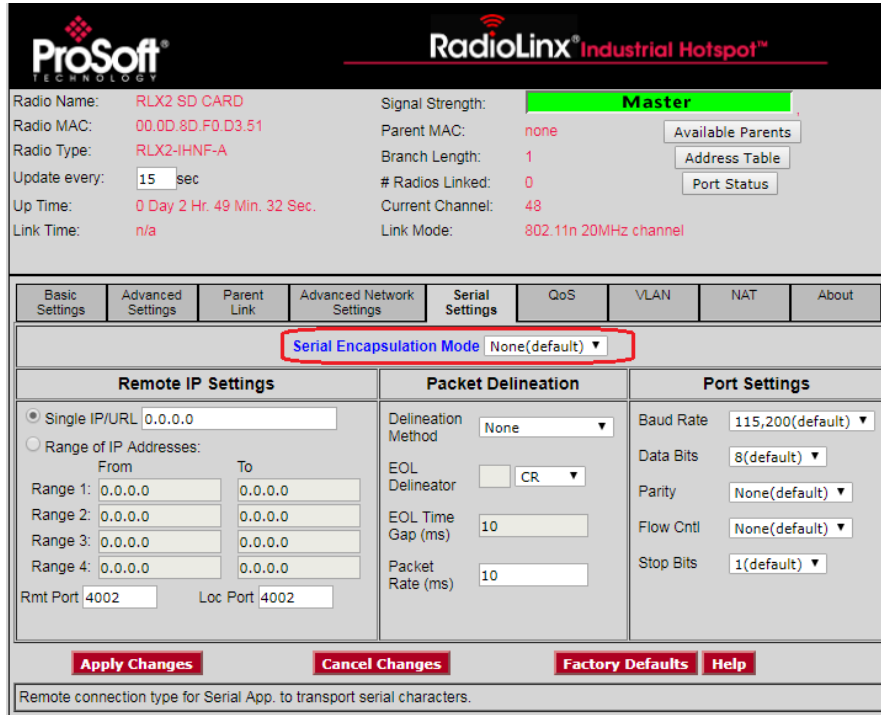

Parameter	Description
Serial Encapsulation Mode	<p>Specifies the serial encapsulation that the radio uses in serial communication.</p> <p>NONE - No serial data encapsulation.</p> <p>UDP - You can use programs on networked computers to send short messages or Datagrams. The radio uses the serial port to transmit and receive packets.</p> <p>Note: In UDP mode if you enter a multicast group address in the REMOTE IP SETTINGS group parameters, then packets are sent to that address or addresses.</p> <p>TCP SERVER - Only connections from this address will be accepted. Once the session is established, the serial port is enabled to transmit and receive packets.</p> <p>Note: To accept connections from any IP address the parameter should be set to 0.0.0.0.</p> <p>TCP CLIENT - In TCP Client mode, a TCP connection will be established with this address.</p>

When the session is established, the serial port is enabled to transmit and receive packets.

4.7.2 Remote IP Settings

You use the **REMOTE IP SETTINGS** parameters to specify the address and port information for the remote radios for serial communication of your RLX2-IHx series radio.

The screenshot shows the configuration interface for a RadioLinX Industrial Hotspot. The top section displays radio information: Radio Name (RLX2 SD CARD), Radio MAC (00.0D.8D.F0.D3.51), Radio Type (RLX2-IHNF-A), Update every (15 sec), Up Time (0 Day 2 Hr. 52 Min. 18 Sec.), Link Time (n/a), Signal Strength (Master), Parent MAC (none), Branch Length (1), # Radios Linked (0), Current Channel (48), and Link Mode (802.11n 20MHz channel). Below this is a navigation menu with tabs for Basic Settings, Advanced Settings, Parent Link, Advanced Network Settings, Serial Settings, QoS, VLAN, NAT, and About. The Serial Settings tab is active, showing Serial Encapsulation Mode set to None(default). The Remote IP Settings section is highlighted with a red box and contains the following fields: Single IP/URL (0.0.0.0), Range of IP Addresses (four ranges, each with From and To fields set to 0.0.0.0), Rmt Port (4002), and Loc Port (4002). Other sections include Packet Delineation (Delineation Method: None, EOL Delineator: CR, EOL Time Gap: 10 ms, Packet Rate: 10 ms) and Port Settings (Baud Rate: 115,200, Data Bits: 8, Parity: None, Flow Cntl: None, Stop Bits: 1). Buttons for Apply Changes, Cancel Changes, Factory Defaults, and Help are at the bottom.

Parameter	Description
Single IP/URL Address	Specifies the IP address or URL of the radio to receive encapsulated serial protocol packets from this radio.
Range of IP Addresses	Specifies up to 4 IP Address ranges for radios to receive encapsulated serial protocol packets from this radio.
Rmt Port	Specifies the remote UDP port number to use for encapsulated serial data transmission.
Loc Port	Specifies the local UDP port number to use for encapsulated serial data transmission.

4.7.3 Packet Delineation Settings

You use the **PACKET DELINEATION** parameters to specify the way the radio separates serial packets for serial communication of your RLX2-IHx series radio.

The screenshot shows the configuration page for a RadioLinx Industrial Hotspot. At the top, the ProSoft Technology logo and RadioLinx Industrial Hotspot™ branding are visible. Below the header, various status and configuration parameters are listed, including Radio Name (RLX2 SD CARD), Radio MAC (00.0D.8D.F0.D3.51), Radio Type (RLX2-IHNF-A), Signal Strength (Master), Parent MAC (none), Branch Length (1), # Radios Linked (0), Current Channel (48), and Link Mode (802.11n 20MHz channel). A navigation bar contains tabs for Basic Settings, Advanced Settings, Parent Link, Advanced Network Settings, Serial Settings, QoS, VLAN, NAT, and About. The Serial Settings tab is active, showing Serial Encapsulation Mode set to None(default). The Packet Delineation section is highlighted with a red box and contains the following settings: Delineation Method (None), EOL Delineator (CR), EOL Time Gap (ms) (10), and Packet Rate (ms) (10). Other sections include Remote IP Settings (Single IP/URL: 0.0.0.0) and Port Settings (Baud Rate: 115,200, Data Bits: 8, Parity: None, Flow Cntl: None, Stop Bits: 1). Buttons for Apply Changes, Cancel Changes, Factory Defaults, and Help are at the bottom. A note at the very bottom states: "Packet delineation: Area to specify the end of a packet."

Parameter	Description
Delineation Method	<p>Specifies the packet separator.</p> <p>TIME GAP - The radio uses a minimum time gap between characters that the radio interprets as a delineator for a packet. This uses the EOL TIME GAP parameter.</p> <p>NONE - The radio sends all data received between packet delineation events to the remote radio in a single network frame.</p> <p>CHARACTER - The radio uses a character sequence in the stream of characters that indicates the delineator for the packet. This uses the EOL DELINEATOR parameter.</p>

EOL Delineator	<p>Specifies the type of delineator the radio uses between packets when you select CHARACTER for DELINEATION METHOD.</p>																															
<table border="1"> <thead> <tr> <th data-bbox="540 279 690 321">Type</th> <th data-bbox="690 279 824 321">Decimal</th> <th data-bbox="824 279 959 321">Hex</th> <th data-bbox="959 279 1385 321">Description</th> </tr> </thead> <tbody> <tr> <td data-bbox="540 321 690 415">Use Text</td> <td data-bbox="690 321 824 415"></td> <td data-bbox="824 321 959 415"></td> <td data-bbox="959 321 1385 415">Any string of characters. Enter the string of characters in the EOL Delineator box.</td> </tr> <tr> <td data-bbox="540 415 690 457">CR</td> <td data-bbox="690 415 824 457">13</td> <td data-bbox="824 415 959 457">0D</td> <td data-bbox="959 415 1385 457">Carriage Return</td> </tr> <tr> <td data-bbox="540 457 690 499">ESC</td> <td data-bbox="690 457 824 499">27</td> <td data-bbox="824 457 959 499">1B</td> <td data-bbox="959 457 1385 499">Escape</td> </tr> <tr> <td data-bbox="540 499 690 541">LF</td> <td data-bbox="690 499 824 541">10</td> <td data-bbox="824 499 959 541">0A</td> <td data-bbox="959 499 1385 541">Line Feed (New Line / nl)</td> </tr> <tr> <td data-bbox="540 541 690 583">Null</td> <td data-bbox="690 541 824 583">00</td> <td data-bbox="824 541 959 583">00</td> <td data-bbox="959 541 1385 583">Null</td> </tr> <tr> <td data-bbox="540 583 690 625">Spacebar</td> <td data-bbox="690 583 824 625">32</td> <td data-bbox="824 583 959 625">20</td> <td data-bbox="959 583 1385 625">Space</td> </tr> <tr> <td data-bbox="540 625 690 657">Tab</td> <td data-bbox="690 625 824 657">09</td> <td data-bbox="824 625 959 657">09</td> <td data-bbox="959 625 1385 657">Horizontal Tab</td> </tr> </tbody> </table>	Type	Decimal	Hex	Description	Use Text			Any string of characters. Enter the string of characters in the EOL Delineator box.	CR	13	0D	Carriage Return	ESC	27	1B	Escape	LF	10	0A	Line Feed (New Line / nl)	Null	00	00	Null	Spacebar	32	20	Space	Tab	09	09	Horizontal Tab
Type	Decimal	Hex	Description																													
Use Text			Any string of characters. Enter the string of characters in the EOL Delineator box.																													
CR	13	0D	Carriage Return																													
ESC	27	1B	Escape																													
LF	10	0A	Line Feed (New Line / nl)																													
Null	00	00	Null																													
Spacebar	32	20	Space																													
Tab	09	09	Horizontal Tab																													
EOL Time Gap (milliseconds)	<p>Specifies the time gap the radio uses between packets when you select TIME GAP for DELINEATION METHOD. This is the length of time that must elapse after a character is received (from the local attached device) before the radio marks the end of a packet.</p> <p>The smallest valid value for this parameter is limited by the device and is platform dependent.</p>																															
Packet Rate (milliseconds)	<p>Specifies the minimum time gap that the radio interprets as an inter-packet space. When the radio detects this time gap, it defines the characters received up to that point as a single packet and sends it to the remote radio.</p> <p>Valid values are 1,000 to 500,000.</p>																															

4.7.4 Port Settings

You use the **PORT SETTINGS** parameters to specify the serial port settings of your RLX2-IHx series radio.

The screenshot shows the configuration interface for a ProSoft RadioLinX Industrial Hotspot. The 'Serial Settings' tab is selected, and the 'Port Settings' section is highlighted with a red border. The 'Port Settings' section includes the following fields:

- Baud Rate: 115,200(default)
- Data Bits: 8(default)
- Parity: None(default)
- Flow Cntl: None(default)
- Stop Bits: 1(default)

Other visible settings include:

- Radio Name: RLX2 SD CARD
- Radio MAC: 00.0D.8D.F0.D3.51
- Radio Type: RLX2-IHNF-A
- Update every: 15 sec
- Up Time: 0 Day 2 Hr. 55 Min. 34 Sec.
- Link Time: n/a
- Signal Strength: Master
- Parent MAC: none
- Branch Length: 1
- # Radios Linked: 0
- Current Channel: 48
- Link Mode: 802.11n 20MHz channel

Parameter	Definition
Baud Rate	Specifies the baud rate for the serial port on the radio. This must match the baud rate setting on the connected serial device.
Data Bits	Specifies the number of data bits for the serial port on the radio. This must match the data bits setting on the connected serial device. Values: 5, 6, 7 or 8
Parity	Specifies the parity for the serial port on the radio. This must match the parity setting on the connected serial device. Values: None, Even, Odd, 1 or 0
Flow Control	Specifies the flow control (handshaking) mode for the serial port on the radio. This must match the handshaking mode setting on the connected serial device. Values: None or Hardware
Stop Bits	Specifies the stop bits for the serial port on the radio. The stop bits on the radio must match the stop bits setting on the connected serial device. Values: 1 or 2

4.8 Configuring Quality of Service (QoS) Settings

You use the **QOS** settings tab to specify the packet priority value parameters for a RLX2-IHx series radio.

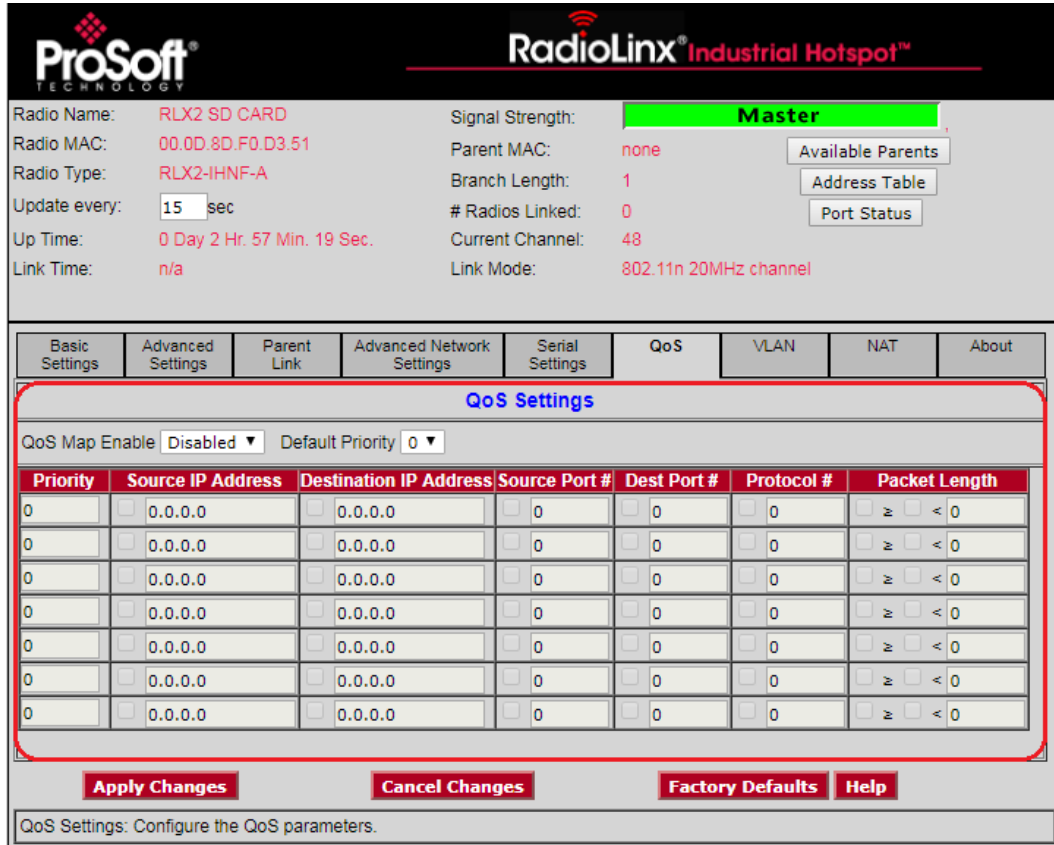

RLX2-IHx series radios always prioritize frames using QoS for packets received already marked with a priority value. The **QoS** tab allows you to set the default priority for frames that the radio receives without any priority markings. In addition, you can map a priority value to packets received without priority markings according to a set of matching criteria.

Parameter	Description
QoS Map Enable	Specifies whether the the RLX2-IHx series radio uses the priority mapping function. ENABLED - The radio uses the priority mapping table to prioritize packets without a priority value. You must select Enabled before you can edit the QoS Map table. DISABLED - The radio does not set priority values for packets without a priority value.
Default Priority	Specifies the default priority for packets received on the Ethernet interface without a priority value (default is 0 - no priority).

Parameter	Description
QoS Map Table	<p>Specifies up to eight separate match criteria to identify and assign priority values to received Ethernet packets. Each filter has several parameters that you can enable by selecting the check box to the left of each parameter. When you enable multiple parameters in a row, all enabled parameters in that row must match before the radio assigns the specified PRIORITY value to a packet.</p> <p>PRIORITY - The priority value the radio assigns to the received Ethernet frame if it was not already marked with a priority value and if all enabled parameters in the same row match.</p> <p>SOURCE IP ADDRESS - A parameter match occurs for all packets received from the device with this source IP address.</p> <p>DESTINATION IP ADDRESS - A parameter match occurs for all packets received addressed to the device with this destination IP address.</p> <p>SOURCE PORT No. - A parameter match occurs for all IP packets received with this source port value.</p> <p>DEST PORT No. - A parameter match occurs for all IP packets received with this destination port value.</p> <p>PROTOCOL No. - A parameter match occurs for all IP packets received with this protocol number.</p> <p>PACKET LENGTH - A parameter match occurs for all iP packets received with the correct packet length.</p> <ul style="list-style-type: none"> ▪ You must enter a packet length threshold ▪ You must select the match criteria: Select < to match if the length of the received packet is LESS THAN the threshold. ▪ Select ≥ to match if the length is GREATER THAN OR EQUAL TO the threshold. ▪ Select both < and ≥ to match ALL PACKET LENGTHS.

4.9 Configuring VLAN Settings

You use the **VLAN** tab to specify the Virtual Local Area Network parameters of a RLX2-IHx series radio. When the radio sends a packet, it includes the configured VLAN ID.

ProSoft TECHNOLOGY **RadioLinX[®] Industrial Hotspot[™]**

Radio Name: **RLX2 Master 1** Signal Strength: **Master**
 Radio MAC: **00.0D.8D.F0.E5.2A** Parent MAC: **none** Available Parents
 Radio Type: **RLX2-IHNF-A** Branch Length: **1** Address Table
 Update every: **15** sec # Radios Linked: **1** Port Status
 Up Time: **0 Day 0 Hr. 44 Min. 5 Sec.** Current Channel: **132**
 Link Time: **n/a** Link Mode: **802.11n 20MHz channel**

Basic Settings | Advanced Settings | Parent Link | **Advanced Network Settings** | Serial Settings | QoS | **VLAN** | NAT | About

VLAN Settings

VLAN Enable: **Enabled** ▼

External Interface Ingress PVID
 Ethernet Interface: **1** ▼
 SSID (WIFI BSS): **100** ▼

Internal Application VLAN ID
 Mgmt Interface (Web, FTP): **1** ▼
 ENIP/Modbus Access: **50** ▼
 Telnet Logging Access: **50** ▼
 SNMP Access: **1** ▼

Main IP Address
 Main: **10.23.1.114**
 Mask: **255.255.255.0**

Alternate IP Address
 Alt: **0.0.0.0**
 Mask: **0.0.0.0**

VLAN ID	Ethernet Member	Ethernet Egress Action
1	<input checked="" type="checkbox"/>	Tag ▼
50	<input checked="" type="checkbox"/>	Tag ▼
100	<input checked="" type="checkbox"/>	Tag ▼
0	<input type="checkbox"/>	Untag ▼
0	<input type="checkbox"/>	Untag ▼
0	<input type="checkbox"/>	Untag ▼
0	<input type="checkbox"/>	Untag ▼
0	<input type="checkbox"/>	Untag ▼
0	<input type="checkbox"/>	Untag ▼
0	<input type="checkbox"/>	Untag ▼

Apply Changes **Cancel Changes** **Factory Defaults** **Help**

RSSI(Received Signal Strength Indication): Strength of the signal FROM THE PARENT radio.

RLX2-IHx series radios support port based VLANs. Each RLX2-IHx series radio can be considered to have 3 different ports or interfaces; the Ethernet interface, the local applications stack of the radio itself, and the 802.11 BSS created by each radio, allowing client devices to associate.

You can configure the VLAN settings for the Ethernet interface on all RLX2-IHx series radios. You can only configure the VLAN for the Internal Application and SSID ports on the Master radio. The Master radio pushes these settings to each connected Repeater radio. This allows the VLAN settings for a bridged network rooted at a Master radio to have common settings for these ports. For example, this ensures that if the Local interface is set to a management VLAN, then all Repeater radios are accessible from a Management PC.

To facilitate customer networks that use VLANs to separate management of network components from operational functions, the RLX2-IHx has the ability to assign different VLAN IDs to these functions. This allows the configuration and firmware upgrade functions to be accessible only from a management VLAN, leaving the ENIP module on an operational VLAN so it can be accessed by PLCs or Master Controllers.

In the example configuration above, the RLX2-IHx is configured with three VLANs forming a trunk link on the RLX2-IHx's Ethernet interface. The management VLAN has VLAN ID of **1**, the operational VLAN has VLAN ID of **50** and a user wireless access network has a VLAN ID of **100**.

This configuration assumes the RLX2-IHx is connected to a managed switch that is VLAN capable. Settings changes can only be done from VLAN 1 (the management VLAN). Users connecting to the RLX2-IHx wirelessly can neither make settings changes nor can they access the operational network.

For customer networks that assign a different subnet on each VLAN, the RLX2-IHx supports the configuration of a 2nd Alternate IP Address via the **Basic Settings > Access Setting** section of the RLX2-IHx webpage. This allows the internal applications to be accessed with either IP Address as long as the packet is tagged with the VLAN ID assigned to that application.

For more information, see *Appendix D - RLX2-IHx series Virtual LAN (VLAN) Functionality* (page 205).

Parameter	Description
VLAN Enable	<p>Select this check box to enable the VLAN function of the radio.</p> <ul style="list-style-type: none"> ▪ When enabled, packets received by the radio on an interface that are not VLAN tagged are assigned to the VLAN as set by the PVID parameter of the respective interface. ▪ When disabled, the radio still bridges received Ethernet packets that are VLAN tagged but does not act on the VLAN ID of the frame or add or remove any VLAN tags.
Ethernet (ingress) PVID SSID (ingress) PVID	Specifies the PVID setting; representing the VLAN ID to assign to non-tagged ingress frames from each interface (Ethernet, SSID).
Internal Application VLAN ID	<p>Specifies the VLAN ID to assign to applications on the RLX2-IHx.</p> <ul style="list-style-type: none"> ▪ The <i>Mgmt Interface</i> setting assigns a VLAN ID to the Web and FTP servers, allowing configuration and firmware update access. ▪ The <i>ENIP/Modbus</i> setting assigns a VLAN ID to the ENIP and Modbus agents, allowing access to those modules from PLCs only from the assigned VLAN. ▪ The <i>Telnet</i> setting assigns a VLAN ID to the Telnet Server, allowing logging access by a Telnet Client (Ex. IH Browser) only from the assigned VLAN. ▪ The <i>SNMP</i> setting assigns a VLAN ID to the SNMP Agent, allowing access by SNMP Managers from the assigned VLAN.
VLAN Settings	<p>Specifies the details for each VLAN.</p> <p>Use the VLAN Table to add a VLAN ID to the RLX2-IHx, and specify whether the Ethernet interface is a member of that VLAN and whether egress frames should be tagged or untagged for a particular VLAN. You can configure up to 15 different VLAN ID's.</p> <p>VLAN ID - The ID of the VLAN to be included on this RLX2-IHx. Valid VLAN ID's range from 1 to 4096. Note that VLAN ID's 1956 and 1957 are reserved and cannot be used.</p> <p>ETHERNET MEMBER - Specifies whether to make the Ethernet interface of the radio a member of the VLAN indicated by the row's VLAN ID.</p> <p>ETHERNET EGRESS ACTION - Specifies whether frames belonging to the row's VLAN ID are sent out the Ethernet port as TAGGED or UNTAGGED.</p>

4.10 Configuring NAT Settings

You use the NAT tab to specify the Network Address Translation parameters of a RLX2-IHx radio. This feature maps a set of external IP Addresses to internal 'private' IP Addresses in a 1:1 manner.

ProSoft TECHNOLOGY **RadioLinX** Industrial Hotspot™

Radio Name: **RLX2 SD CARD** Signal Strength: **Master**
 Radio MAC: **00.0D.8D.F0.D3.51** Parent MAC: **none** Available Parents
 Radio Type: **RLX2-IHNF-A** Branch Length: **1** Address Table
 Update every: **15** sec # Radios Linked: **0** Port Status
 Up Time: **0 Day 3 Hr. 30 Min. 54 Sec.** Current Channel: **48**
 Link Time: **n/a** Link Mode: **802.11n 20MHz channel**

Basic Settings | Advanced Settings | Parent Link | Advanced Network Settings | Serial Settings | QoS | VLAN | **NAT** | About

NAT Settings

NAT Enable: **Enabled** LAN IP Address: **192.168.3.2** LAN Subnet Mask: **255.255.255.0** **Add Entry**
Delete

Delete	AutoIP	Type	Internal IP	Dest IP	External IP
<input type="checkbox"/>	<input type="checkbox"/>	None	n/a	n/a	0.0.0.0

Apply Changes **Cancel Changes** **Factory Defaults** **Help**

NAT Settings: Configure the NAT table and parameters.

When NAT is enabled, the RLX2-IHx Ethernet port becomes the default gateway for the internal private network and the wireless interface provides access to the external network. The IP Address configured for the RLX2-IHx via the *Basic Settings* Tab must valid on the external network. The IP Address used for the internal network, and which must be configured as the default gateway on all devices on that internal network, is configured via the *NAT* tab in the *LAN IP Address* and *LAN Subnet Mask* fields.

There are 2 types of NAT entries: *1:1 Src* entries and *1:1 Dst* entries. All devices on the internal network that wish to access or wish to be accessed from the external network must have a 1:1 Src entry in the NAT table to translate their internal IP Address to an external IP Address. This means that the most devices that an RLX2-IHx can support on the internal network is 16 (max NAT Table size), when NAT is enabled.

The 1:1 Dst type entries allow a device on the internal network to address a device on the external network using a local internal IP Address. This entry type is not often used, but does allow configuration of devices on the internal network to be agnostic of any external IP Address, relying on the NAT table to map a 'standard' set of local external IP Addresses to their actual external equivalents.

Parameter	Description
NAT Enable	This enables or disables the NAT function of the RLX2-IHx. NAT is only available if the RLX2-IHx is in Repeater or Bridging Client mode. In Master or Client modes the NAT Tab is disabled. If NAT is disabled, then no Network Address Translation (NAT) occurs and the RLX2-IHx operates in normal Repeater or Bridging Client mode. When NAT is Enabled the source IP Address and optionally the destination IP Address of packets going from the RLX2-IHx Ethernet to the wireless interface are translated according to the NAT Table entries for those IP Addresses. The reverse translations occur for packets going from the wireless interface to the RLX2-IHx Ethernet.
LAN IP Address	The LAN IP Address becomes the IP Address the RLX2-IHx uses for its Ethernet interface. When NAT is enabled the RLX2-IHx operates like a NAT router and this IP Address must also be the default gateway for the internal private network. The default for this IP Address is 192.168.1.1 and should be changed if a different subnet is desired for the internal network.
LAN Subnet Mask	The LAN Subnet Mask defaults to 255.255.255.0 to match type C address default for the LAN IP Address. It is important to set the subnet mask correctly on the RLX2-IHx and that it matches the subnet mask configured in each of the Ethernet devices on the internal network.
Add Entry	This button is used to add a new entry to the NAT table. When pressed a new row appears at the end of the list in the table view. Up to 16 entries can be present in the NAT table. Attempting to add more will pop up an error message dialog. Once added the fields of the entry must be set according to the type of translation and the IP Addresses to be translated. Note that the entry is only saved once the Apply Changes button is pressed.
Delete	This button is used to remove selected entries from the NAT table. When pressed any entries that have the checkbox in the Delete column checked, will be removed from the list. Once an Apply Changes is done the entry is permanently removed. If the webpage is refreshed prior to doing an Apply Changes, then the original NAT entries will repopulate the list.

Parameter	Description
NAT Table	<p>The NAT Table contains entries that inform the NAT function on the type of translation and on which IP Addresses the translation should occur. Each field of an entry row is described below:</p> <p>Delete - Rows that have this checkbox checked will be removed from the NAT table if the Delete button is pressed.</p> <p>AutoIP - When checked this indicates that the External IP Address field will be calculated based on the main IP Address of the RLX2-IHx using the following formula: Ext IP Addr = RLX2-IHx IP Address + offset, where offset = 1 and is incremented for each row encountered that has the AutoIP checkbox selected, walking down the table.</p> <p>The main benefit of this feature is to enable an IP Address assignment plan that only requires one IP Address setting on the RLX2-IHx, allowing the configuration to be cloned to multiple identical networks each with the same internal IP Addresses but differing only in the one external IP Address that is configured.</p> <p>Type - The type of 1:1 NAT translation to be done. Either 1:1 Src or 1:1 Dst must be selected. The appropriate IP Address fields in the entry will be enabled depending on the setting.</p> <p>Internal IP - The IP Address of a device on the internal network that will be translated to the IP Address in the External IP field of this row of the table, for packets going from Ethernet to wireless. The reverse translation occurs on the destination IP Address of packets going from wireless to Ethernet that match an External IP Address in the NAT Table. If the entry is a 1:1 Src type then the destination IP Address in the packet is translated to the Src IP Address in the entry.</p> <p>Dest IP - The internal IP Address representing an external device. When this IP Address appears as the destination of a packet going from the Ethernet to wireless it will be translated to the External IP Address of the entry. The reverse translation occurs on the Source IP Address of packets going from wireless to Ethernet that match an External IP Address in the NAT Table. If the entry is a 1:1 Dst type then the source IP Address is translated to the Dest IP Address in the entry.</p> <p>External IP - An IP Address on the external network that is translated to/from internal IP Addresses that are in the NAT Table.</p>

4.11 About This Unit

This tab displays the version of various modules that have been loaded and are running in this unit.

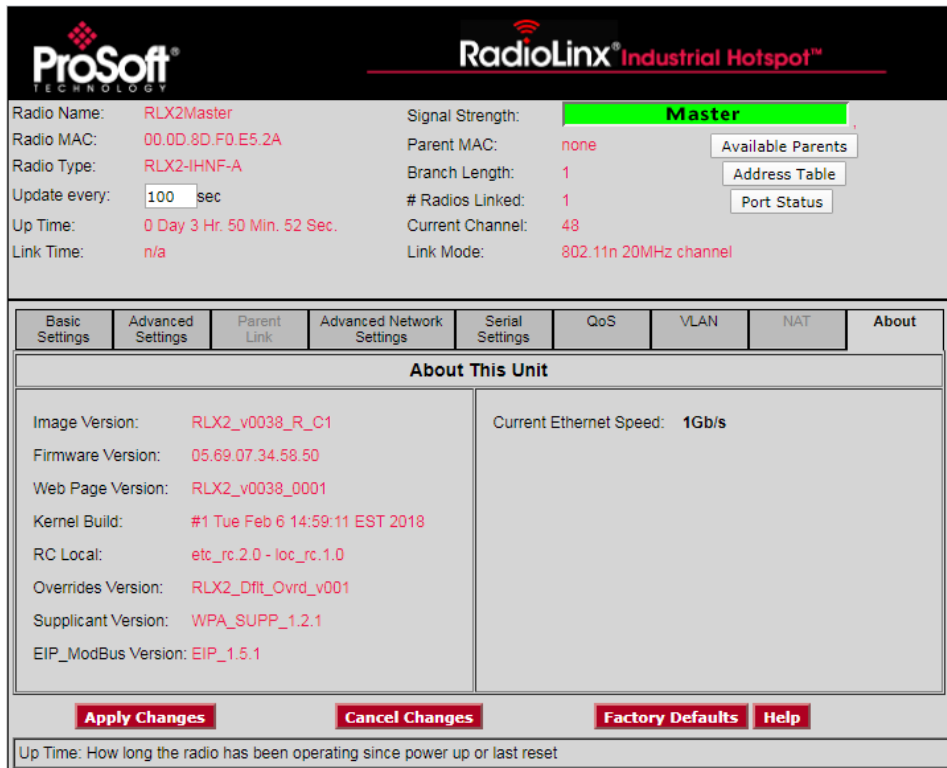

Parameter	Description
Image Version	This represents the software version that was last loaded into the unit. Example: RLX2_v0036H_R . This Software Image is available for download from the ProSoft website. This Software Image is a combo image that contains many sub-components.
Firmware Version	This is the main radio driver version number and is one sub-component of a Software Image.
Webpage Version	This is the version of the webpages that are available for management of the unit via its web interface.
Kernel Build	This date identifies when the OS kernel running in this unit was built.
Overrides Version	This is the version of the default override file that is also a sub-component of the Software Image. The override file would only be different when custom default overrides have been included in a special Software Image.
Supplicant Version	This is the version of the WPA Supplicant that is responsible for Enterprise level Security and also used for the Security exchange during FT Roaming.
EIP-Modbus Version	This is the version of the EIP/Modbus Agent that allows observation of radio status and parameters using Ethernet I/P or Modbus queries.

5 Using the IH Browser to Manage your Radios

The *RadioLinX Industrial Hotspot Browser* (IH Browser) finds RLX2-IHx series radios connected to the network. It displays the radio's status and basic settings.

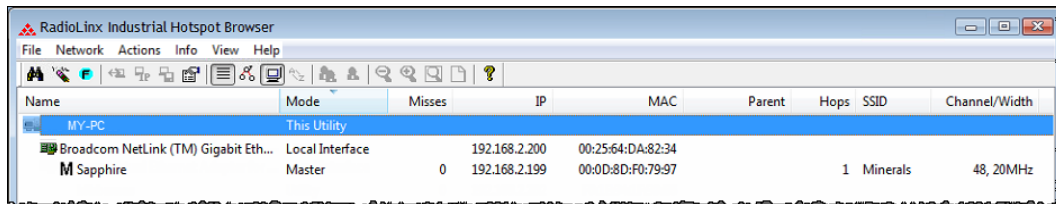

You can use the IH Browser to perform a number of tasks, including:

- View all the radios connected through the network to your PC in either a list (table) or topology view.
- Assign a temporary IP address to a radio.
- Update the firmware in the radio.
- View a list of client radios.
- View a list of all the access points detected on the network (including those from other vendors)
- View the radio's properties.
- Launch the PC's web browser to log into the radio to configure or check diagnostics for your radio.
- Show the Event Log with a history of events that occurred on the radio.
- Send a ping command to a radio or other IP address.
- View a list of wired Ethernet nodes connected to the network.
- View a list of all the active interface ports on the radio.
- View the radio's Event Log.

5.1 Viewing the Radios in the IH Browser

Start the IH Browser: see Starting the IH Browser (page 22). If the radio is powered up and connected, it appears in the IH Browser. Note that the *MAC* address is the same address as that of the label on the radio. The *List* view (shown in the image below) displays the RLX2-IHx series radios (or previous generation RLXIB radios, except the RLCIB-IHN) on the same network as the computer running the IH Browser.

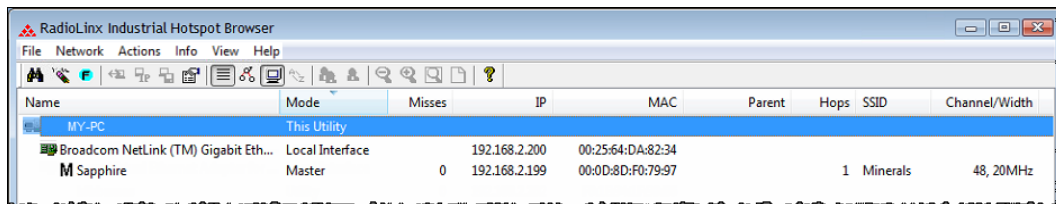



Note: You can perform many common tasks by right-clicking on the radio and choosing a command.

5.1.1 Refreshing the Display in the IH Browser

To refresh the display

If you have made changes to a radio's configuration, refresh the IH Browser by clearing and scanning the display using the buttons on the toolbar.

-  The *Erase* button clears the radios from display (or from the **FILE** menu choose **CLEAR**).
-  The *Scan* button rescans the network for RLX2-IHx series radios (or from the **FILE** menu choose **SCAN**).

5.1.2 Defining the Scan Parameters in the IH Browser

You use the *Scan Setup* dialog box to specify how the IH Browser refreshes the display when scanning the network. By default, the program sends a broadcast Scan message to all the radios at the same time, then waits for them to respond. Broadcasts are limited to a local network, and will not be passed through a router.

If there is a router between the PC running the IH Browser and the radio, enter the IP address of a single radio or the range of IP addresses of multiple radios. This adds them to the IP addresses the IH Browser scans.

To define the scan parameters, from the **NETWORK** menu, choose **SCAN SETUP**.

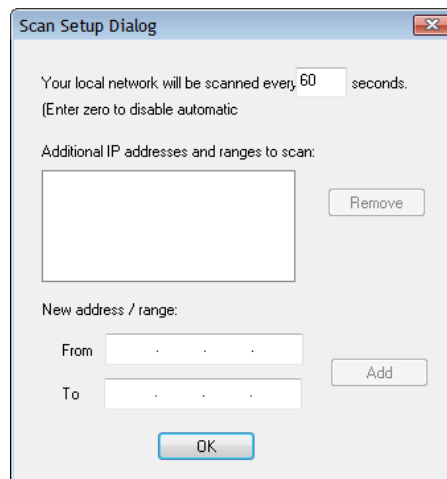

Parameter	Description
Local network scanning interval	Specifies how often the IH Browser scans the network before updating the display. Enter zero to disable automatic scanning. You can still scan the network manually. See Refreshing the Display in the IH Browser (page 38).
Additional IP addresses	Displays the IP addresses the IH Browser scans at the scanning interval.
Remove	Removes the selected IP address or range. Click on an IP address or address range to select it.
New Address / Range	Enter the new IP address (in FROM) or range of IP addresses (in FROM and TO) and then click ADD .

5.1.3 Freezing the Display in the IH Browser

Freezing the display in the IH Browser prevents it from updating with new data.

To freeze the display

-  The *Freeze* button on the IH Browser toolbar prevents the display from updating (or from the **FILE** menu choose **FREEZE**).
- Click the *Freeze* button again to start updating the display.

5.1.4 Changing IH Browser Columns in List View

You can change the columns that appear in the IH Browser main window in List View.

To change the columns in the IH Browser window

- 1 From the **VIEW** menu, click **SELECT COLUMNS**.
- 2 In the *Select Columns* dialog box, click the check boxes for the columns you want to appear in the window.

To reset the columns in the IH Browser window to the default



From the **VIEW** menu, click **RESET COLUMNS**.

5.1.5 Switching between List and Topology Views

You can switch between the List and Topology Views in the IH Browser main window.

- The *List View* is the default view, and shows a list of all the connected radios in a grid, similar to a spreadsheet.
- The *Topology View* shows a diagram of the network's wireless connections. If a radio does not appear in the view, it is not connected to the network. The Topology View is display-only. If you want to change the way a radio is linked to the network, see *Configuring Parent Link Settings* (page 92).



To switch between the List and Topology views

-  The *List View* button switches to the List View (or from the **VIEW** menu choose **LIST VIEW**). For a description of the available columns, see *List View Columns* (page 124).
-  The *Topology View* button switches to the Topology View (or from the **VIEW** menu choose **TOPOLOGY VIEW**). For a description of the *Topology View*, see *Topology View Description* (page 127).

To change the columns in the List View

- To resize a column, click between column headers and drag left or right.
- To re-order the columns, click a column header and drag it to the left or right.
- To sort the radios, click a column header to change the sort order
- To change the displayed columns, from the **VIEW** menu choose **SELECT COLUMNS**.

To zoom in and out in the Topology View

-  The *Zoom In* button magnifies the *Topology View* (or from the **VIEW** menu choose **ZOOM IN**).
-  The *Zoom Out* button shrinks the *Topology View* (or from the **VIEW** menu choose **ZOOM OUT**).
-  The *Zoom to Fit* button resizes the *Topology View* to fit the window (or from the **VIEW** menu choose **ZOOM TO FIT**).

To sort radios alphabetically in the Topology View

-  The *Sort Alphabetically* button sorts the radios in the by name *Topology View* (or from the **VIEW** menu choose **SORT ALPHABETICALLY**).



To change a radio's configuration in either view

Double-click a radio to launch a web browser to the login page of the radio. See *Connecting to the Radio Configuration Web Interface* (page 40).

List View Columns

This topic describes the available columns in the *List View*. See *Switching between List and Topology Views* (page 123) for more information on the *List View* columns.

Note: You can display most of the same information for the radio in the Detailed Information dialog box the IH Browser. See *Viewing the Radio Properties* (page 129).

Column Name	Description
Name	<p>Displays the devices in the IH Browser. Names appear in a nested tree order. The icons on some entries help identify the type of device.</p> <ul style="list-style-type: none">  Computer  Wired Network Interface M Master Radio R Repeater Radio C Client Radio Bc Bridging Client Radio





Mode	<p>Displays a text description of the devices in the IH Browser.</p> <p>THIS UTILITY - This instance of the IH Browser.</p> <p>UTILITY - Other instances of IH Browsers running on other systems on the same network.</p> <p>LOCAL INTERFACE - A network interface detected on the computer running this instance of the IH Browser.</p> <p>MASTER - A radio on the network in Master mode.</p> <p>ETHERNET CLIENT - A radio on the network in Client mode</p> <p>BRIDGING CLIENT - A radio on the network in Bridging Client mode.</p> <p>REPEATER - A radio in the network in Repeater mode.</p>
MAC	<p>Displays the physical Media Access Control (MAC) address of the devices. All ProSoft Technology devices have a MAC address in the form 00:0D:8D:XX:YY:ZZ.</p>
IP	<p>Displays the IP addresses assigned to the devices.</p>
Mask	<p>Displays the network mask for the device.</p>
Gateway	<p>Displays the IP address of the network gateway for the device.</p>
SSID	<p>Displays the Service Set Identifier (SSID). This is a name assigned to a wireless network device. Repeater and Client radios must be configured with the same SSID to connect. Note that Master radios typically broadcast their SSID. However, you can disable SSID broadcasting so that other wireless devices cannot detect the Master radio. If a Master is not broadcasting its SSID, this field includes the word HIDDEN along with the SSID of the radio; for example <i>ProSoft/hidden</i>.</p>
Connection	<p>Displays the connection state for a Repeater radio.</p> <p>SCANNING - The radio is searching for a Master radio.</p> <p>CONNECTED - The radio is linked to a Master radio.</p>
Signal (dBm)	<p>Displays the signal strength, in dBm of a Repeater or Client radio's link to a Master device. Master devices do not report signal strength.</p>
Hops	<p>Displays the number of wireless connections from the device to the wired connection of a Master. This value is always 1 for a Master radio. For Repeater radios, the value is at least 2, but can be higher if there are more hops to the Master radio. Client radio do not display a hop value.</p>
Parent	<p>Displays the MAC address of the Parent radio to which this Repeater or Client radio is linked. This is blank for Master devices.</p>
Associations	<p>Displays the number of non-bridge wireless connections to this radio. Client or Bridging Client radios that are connected always show 1 in this column (and 0 in the Bridges column).</p>
Bridges	<p>Displays the number of non-bridge wireless connections to this radio. Client or Bridging Client radios that are connected always show 1 in this column (and 0 in the Bridges column).</p>
Tx (kbits/sec)	<p>Displays a moving average of transmit throughput in kilobits/second. It does not count packet overhead, and only counts payload data. For Repeater radios, this shows the throughput only for the radio link to the Parent radio. For Master radios, this is the throughput sum of all the Master's radio links.</p>
Rx (kbits/sec)	<p>Displays a moving average of receive throughput in kilobits/second. It does not count packet overhead, and only counts payload data. For Repeater radios, this shows the throughput only for the radio link to the Parent radio. For Master radios, this is the throughput sum of all the Master's radio links.</p>

FW Ver	<p>Displays the firmware version number.</p> <ul style="list-style-type: none"> ▪ For IH Browser entries, this is the version of the IH Browser itself. ▪ For radios, this is the version of the firmware code in the radio. This is not the version of the image file installed into the radio (for that information see IMAGE VER described below).
Boot Ver	<p>Displays the boot loader code version number.</p> <ul style="list-style-type: none"> ▪ For IH Browser entries, this is the version of the network communication engine in the IH Browser (e.g. WinXP, WinVista). ▪ For radios, this is the version of the boot loader code in the radio.
Image	<p>Displays the type of the firmware image that the radio is currently running (PRIMARY or SECONDARY). Each radio has two copies of operating firmware installed, and the radio will automatically switch from one to the other if one of them becomes corrupted.</p>
Compression	<p>Displays the compression state of the firmware images in the radio (COMPRESSED or UNCOMPRESSED).</p>
Ethernet	<p>Displays the Ethernet status for the radio.</p> <p>ATTACHED - The radio is connected to a wired Ethernet network.</p> <p>DETACHED - The radio is not connected to a wired Ethernet network.</p>
Channel/Width	<p>Displays the operating channel and channel width. The width value is always 20MHz except on 802.11n devices where it can be 20MHz or 40MHz.</p> <p>Example: 48, 20 MHz for channel 48 with a 20 MHz channel width.</p>
Security	<p>Displays the encryption type setting for the radio. Some valid settings are AES, TKIP, AES&TKIP, WEP128 TKIP, WEP128, WEP64.</p>
Misses	<p>Displays the number of times the IH Browser has failed to receive a response from the device after a scan. Ideally this number should always be zero.</p>
RSTP	<p>Displays the setting for RSTP in the radio (ENABLED, DISABLED, and STP). The STP state is a legacy "non-rapid" Spanning Tree mode that the radio automatically uses if it detects a peer wired bridge in STP mode. All radios on a network must have the same RSTP state to link properly.</p>
Link Time	<p>Displays the link time of the device; for example 24d,13h,10m,32s. This time resets to zero on a Roam, or if the link is dropped and re-established with the same Parent radio.</p>
Tx Rate	<p>Displays the current modulation data rate that the radio is using for transmission. This may be slower than the configured nominal rate because of retries or other environmental factors.</p> <ul style="list-style-type: none"> ▪ For 802.11a/b/g devices, the data rate is expressed in kilobits or megabits per second (for example, 54Mb/s). ▪ For 802.11n devices, the data is expressed in MCS rates from 0 to 15 (for example, MCS7).
Temperature	<p>Displays the internal temperature of the radio as measured on the circuit board in degrees Celsius. Note that internal measured temperature always exceeds the ambient external temperature.</p>
Retries(%)	<p>Displays the ratio of packet re-transmission to total packet transmissions during the last five-second interval for the radio.</p>
Uptime	<p>Displays the amount of time the radio has been running since the last power cycle or reset; for example, 1d,4h,13m,25s.</p>
Product	<p>Displays the model number of the RLX2 radio; for example RLX2-IHA, RLX2-IHG, RLX2-IHFN, RLX2-IHFN-W, or RLX2-IHW.</p>
Image Ver	<p>Displays the name of the image file loaded into the radio; for example, RLX2_v0036_R.</p>

Tx Pkts/Sec	Displays a moving average of transmitted data packets/second. For Repeater radios, this shows the data packet rate transmitted over the radio link to the Parent radio. For Master radios, this is the transmitted data packet rate sum on all the Master's radio links.
Rx Pkts/Sec	Displays a moving average of received data packets/second. For Repeater radios, this shows the data packet rate received over the radio link to the Parent radio. For Master radios, this is the received data packet rate sum on all the Master's radio links.

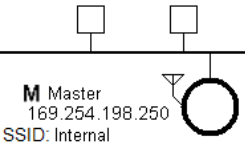
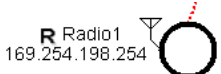
Topology View Description

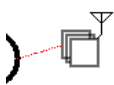
This topic describes the *Topology View*. See *Switching between List and Topology Views* (page 123) for more information on the *Topology View*.

	Indicates the Master radio; always shown at the top.
	Indicates a radio linked to the network.
	Indicates a radio not linked to a Parent radio, but on the same network as the computer hosting the IH Browser.
	Indicates that an Ethernet connection exists to the radio, but does not indicate the number of devices on the connection.
	Indicates that wireless clients (such as laptops and tablet computers) are linked to this radio. The number of clients linked is indicated by the number of boxes and/or a number.
	Indicates signal strength between radios. The width of the line is not calibrated, but a wider line indicates a relatively stronger signal strength.
	Indicates links to alternate Parent radio candidates that could be chosen if the current Parent link drops or degrades.

5.1.6 Printing the View in the IH Browser

You can print the current view in the IH Browser.

- To print the current view, from the **FILE** menu choose **PRINT**.
- To define the page orientation, paper source, and size, from the **FILE** menu choose **PRINT SETUP**.
- To preview the printed view, from the **FILE** menu choose **PRINT PREVIEW**. This can help you adjust the view in the IH Browser so it does not break across pages when printed.
- In the *Topology View*, to display a border around the area to be printed, do one of the following:
 - From the **VIEW** menu, choose **PRINT AREA**.
 - On the IH Browser toolbar click the  **Show Page Outline** button.

5.1.7 Importing and Exporting IH Browser Data

You can export data from, and import data into, the IH Browser. Exporting data creates and saves an XML file containing the current configuration and status of all radios discovered by the IH Browser. You can use this command under the direction of ProSoft Technical Services, for troubleshooting purposes. Importing data brings in the data from a previously created IH Browser XML file.

- To export data from the IH Browser, from the **FILE** menu choose **EXPORT**. You can choose to include the data from the current *Wireless Client*, *Ethernet Nodes*, *Scan List*, and *Port Table* tables. See *Viewing Additional Data* in the IH Browser (page 133) for information about those tables.

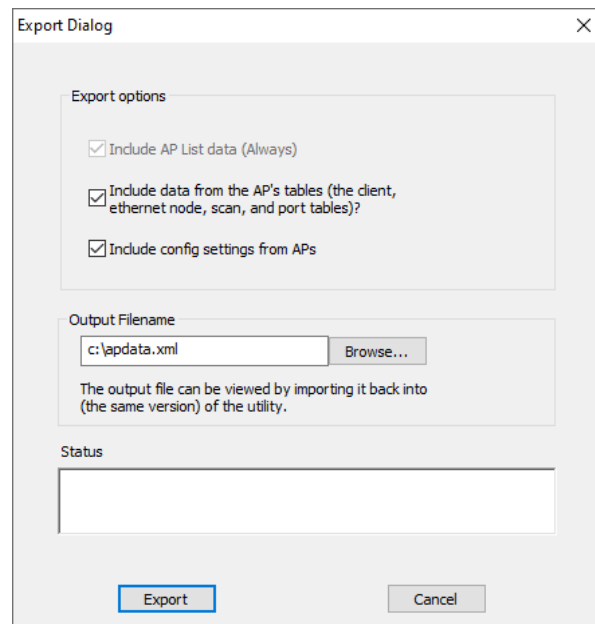

- To import data from an export file created in the IH Browser, from the **FILE** menu choose **IMPORT**.

5.1.8 Hiding the Toolbar and Status Bar in the IH Browser

You can hide and display the Toolbar and Status bar in the IH Browser window.

- To hide and show the Toolbar (1 in the image below), from the **VIEW** menu choose **TOOLBAR**.
- To hide and show the Status Bar (2 in the image below), from the **VIEW** menu choose **STATUS BAR**.

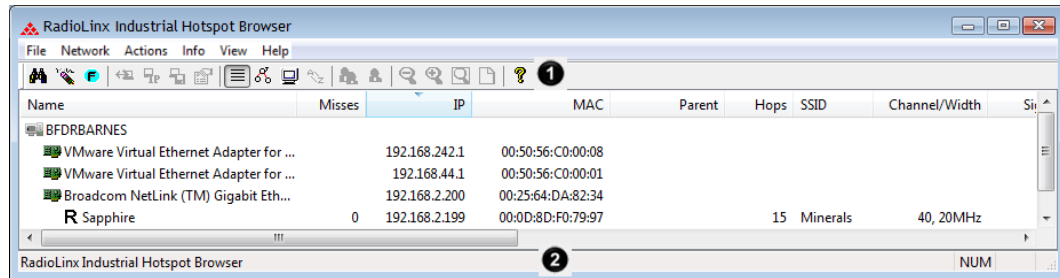

5.2 Viewing the Radio Properties

The *Detailed Information* dialog box shows information about the currently selected radio.

- 1 In the IH Browser, select (click) a radio in either the *List View* or *Topology View*.
- 2 From the **INFO** menu choose **PROPERTIES**, or right-click the radio and choose **PROPERTIES**.

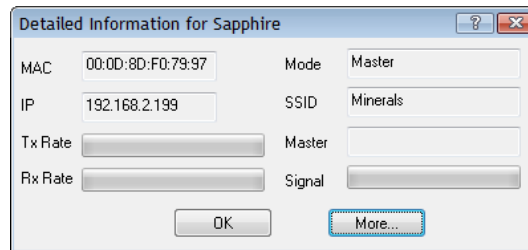

3 Click **MORE** to display more information.

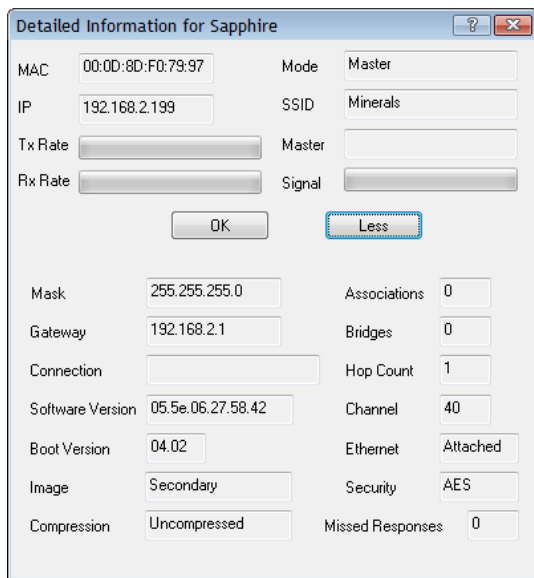

Note: You can display most of the same information in the *List View* in the IH Browser. See *List View Columns* (page 124).

Parameter	Description
MAC	Displays the MAC address of the selected radio.
IP	Displays the IP address of the selected radio.
Mode	Displays the mode of the selected radio (MASTER, REPEATER, CLIENT, BRIDGING CLIENT)
SSID	Displays the SSID of the selected radio.
TX Rate	Displays a green bar when there is transmit activity.
RX Rate	Displays a green bar when there is receive activity.
Master	Displays the MAC address of the radio's current Master radio.
Signal	Displays a green bar when there is a signal.
More / Less	Click MORE to expand the dialog box and display more information. Click LESS to reduce the dialog box and display less information.
Mask	Displays the network mask for the current radio.
Gateway	Displays the network gateway IP for the current radio.
Connection	Displays the connection state for a Repeater radio. SCANNING - The radio is searching for a Master radio. CONNECTED - The radio is linked to a Master radio.
Software Version	Displays the version of the firmware code in the radio. This is not the version of the image file installed into the radio (for that information see IMAGE described below).
Boot Version	Displays the boot loader code version number. This is the version of the boot loader code in the radio.

Parameter	Description
Image	Displays the type of the firmware image that the radio is currently running (PRIMARY or SECONDARY). Each radio has two copies of operating firmware installed, and the radio will automatically switch from one to the other if one of them becomes corrupted.
Compression	Displays the compression state of the firmware images in the radio (COMPRESSED or UNCOMPRESSED).
Associations	Displays the number of non-bridge wireless connections to this radio. Client or Bridging Client radios that are connected always show 1 in this column (and 0 in the Bridges column).
Bridges	Displays the number of non-bridge wireless connections to this radio. Client or Bridging Client radios that are connected always show 1 in this column (and 0 in the Bridges column).
Hop Count	Displays the number of wireless connections from the device to the wired connection of a Master. This value is always 1 for a Master radio. For Repeater radios, the value is at least 2, but can be higher if there are more hops to the Master radio. Client radio do not display a hop value.
Channel	Displays the operating channel for radio.
Ethernet	Displays the Ethernet status for the radio. ATTACHED - The radio is connected to a wired Ethernet network. DETACHED - The radio is not connected to a wired Ethernet network.
Security	Displays the encryption type setting for the radio. Some valid settings are AES , TKIP , AES&TKIP , WEP128 TKIP , WEP128 , WEP64 .
Missed Responses	Displays the number of times the IH Browser has failed to receive a response from the device after a scan. Ideally this number should always be zero.

5.3 Setting the Radio IP Address in the IH Browser

To set the radio IP address

- If the radio is on a network with a DHCP server, it gets an IP address through DHCP.
- If the radio is not on a network with a DHCP server, the radio appears with an IP address of 0.0.0.0. You can assign a temporary IP address to assist with configuring the radio. See *Assigning a Temporary IP Address* (page 39).

5.4 Assigning a Temporary IP Address

A temporary IP address allows you to access and configure a radio when the radio either does not have an IP Address or it has an IP Address that is on a network subnet different than the PC running the IH Browser.

- 1 In the IH Browser, right-click the radio and then click **ASSIGN IP**.

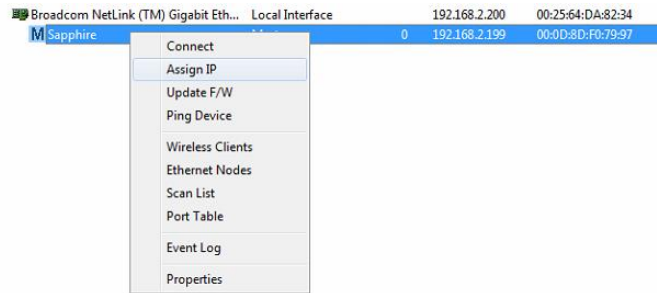

This opens the *Assign Temporary IP Address* dialog box.

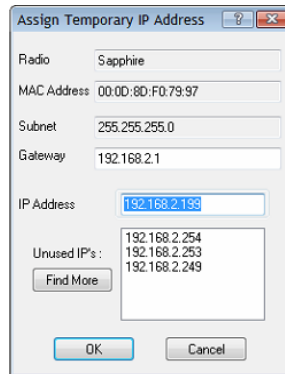

The **UNUSED IP'S** list are the IP addresses that are currently available on the network.

- 2 The IH Browser suggests the network parameters for the temporary IP address. It queries the IP addresses, and displays them if it does not receive a response. Click one of the unused IP's, or enter an unused IP address, and click **OK**. The IH Browser warns you that the IP address is temporary.

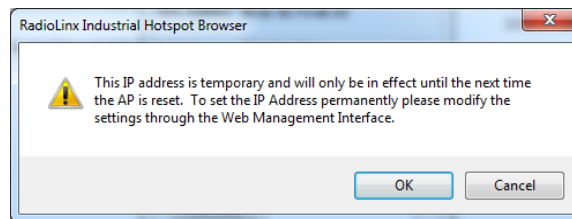

- 3 Click **OK** and refresh the display in the IH Browser. Your radio should now appear in the IH Browser window with the temporary IP address.
- 4 To set a permanent IP address for the radio, see *Configuring a Radio - Getting Started* (page 40).

5.5 Viewing Additional Data in the IH Browser

Start the IH Browser (see Starting the IH Browser (page 22)). If the radio is powered up and connected, it appears in the IH Browser. Note that the *MAC* address is the same address as that of the label on the radio. The *List* view (shown in the image below) displays the RLX2-IHx series radios (or previous generation RLX1B radios, except the RLC1B-IHN) on the same network as the computer running the IH Browser.

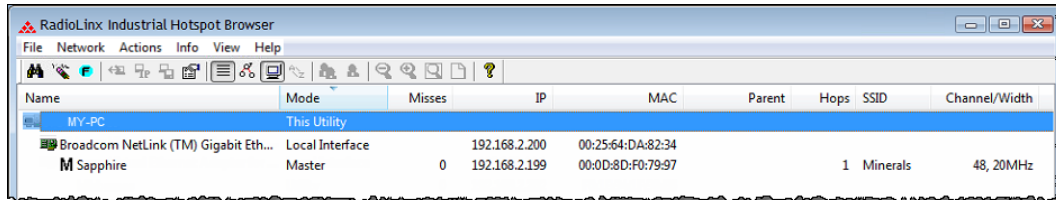

Note: You can perform many common tasks by right-clicking on the radio and choosing a command.

5.6 Connecting to the Radio Configuration Interface

This section describes how to configure a radio using a web browser such as Internet Explorer or Firefox on your PC or other network-enabled device.

To connect to the radio web interface:

Important: Your computer or other device must be connected to the same network as the RLX2-IHx series radio.

- 1 Log into the radio. You can do this in any of three ways:
 - In the IH Browser List view or Topography view, right-click the radio and then click **CONNECT**.
 - In the IH Browser List view or Topography view, double-click the radio.
 - Open a web browser on your PC, and then in the address bar, type `http://`, followed by the IP address for the radio, and then press **ENTER**. For example, `http://192.168.6.10`.

The login screen appears in the web browser.

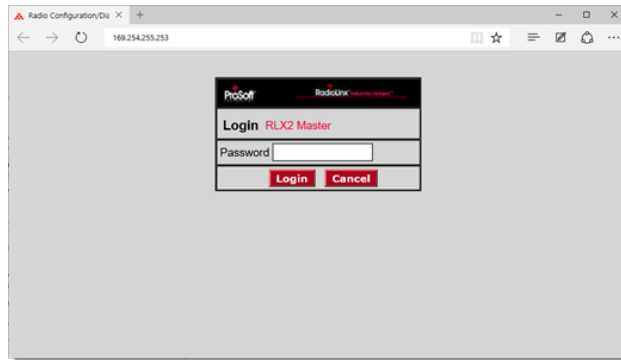

- 2 Enter the password and then click **LOGIN**. The default password is *password*.

If the radio is set to factory defaults see Connecting to the Radio Web Configuration Interface (page 40) for entering an initial password to enable the configuration tabs. If you have lost the password for the radio, you can reset the radio to its default settings. See *Resetting a RLX2-IHx Series Radio* (page 180).

This opens the main webpage for the radio. Note that some parameters may be different from the image depending on your specific radio model.

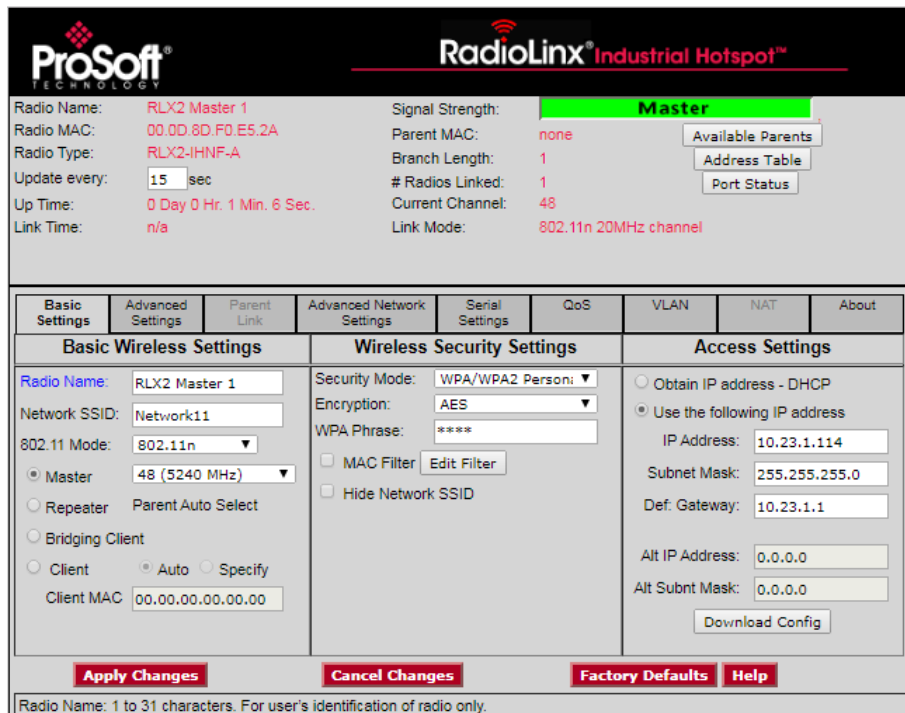

Tip: You can display the help topic for any parameter by clicking the parameter name. The parameter name turns blue when you move the cursor over a parameter with a help topic. There is also a short description of the cursor control at the bottom of the window.

5.7 Updating the Radio Firmware

From time to time, ProSoft Technology may release new firmware for the RLX2-IHx series radio that may include new features and corrected anomalies. We recommend that all RLX2-IHx series radios in a network use the same firmware version. If your network has a mix of RLX2-IHx series models, you can load the same firmware image file into each of them.

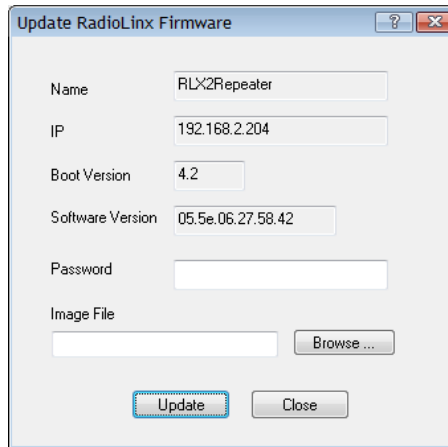

To update the firmware in the radio

- 1 Download the radio firmware image from the Prosoft Technology website at www.prosoft-technology.com and save it to a known location (such as the Windows Desktop).
- 2 Start the IH Browser and click on an RLX2-IHx series radio to select it.
- 3 From the **ACTIONS** menu choose **UPDATE FIRMWARE**. You can also right-click the radio and choose **UPDATE F/W**.
- 4 Enter the password for the radio. This is the same password that you use to log into the radio web interface. See *Connecting to the Radio Web Configuration Interface* (page 40).
- 5 Click **BROWSE** to locate the firmware image file to load.
- 6 Click **UPDATE** to begin copying the new firmware to the radio.

Important: Do not turn off power to the radio during this operation.

5.8 Pinging Devices on the Network

You can use the Ping command to test the latency of the network link between the PC running the IH Browser and any other PC that is also running the IH Browser (called *Ping Stations*).

Note: Currently there is no location information when a ping station responds to an IH Browser scan, therefore, all Ping stations are shown connected to the top main network. It is also possible to select an RLX2-IHx series and start a Ping Session with it.

- 1 Start the IH Browser on your computer.
- 2 To start the ping session, do one of the following:
 - o From the **VIEW** menu choose **SHOW PING STATIONS**.
 - o  Click the *Show Browsers* button on the toolbar.

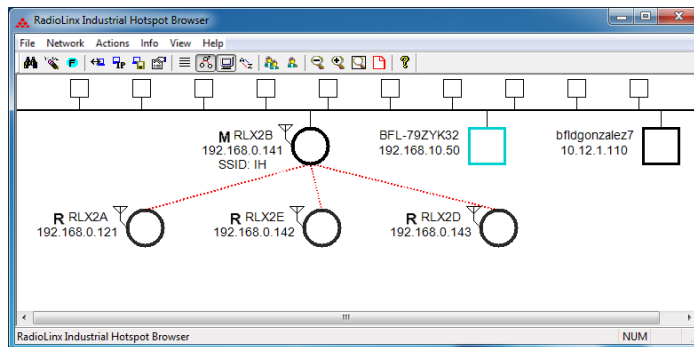

- 3 Click (highlight) one of the other computers visible in the IH Browser.
- 4 From the **ACTIONS** menu choose **PING DEVICE** to open the *Ping Results Dialog* box.

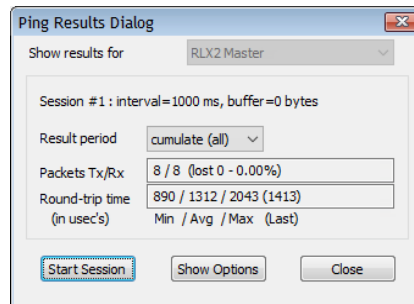

This dialog box displays statistics on the minimum, maximum and average latency between two points on the network.

- 5 Click **SHOW OPTIONS** to change the Ping parameters. See *Ping Options Dialog Box* (page 137).

Note: If there is no PC with an IH Browser behind a remote RLX2-IHx series radio, you can select and ping the radio itself to test its wireless link.

5.8.1 Setting the Ping Parameters

Use the *Ping Options* dialog box to choose Ping parameters, logging options, and response to other stations. For more information, see *Pinging Devices on the Network* (page 136).

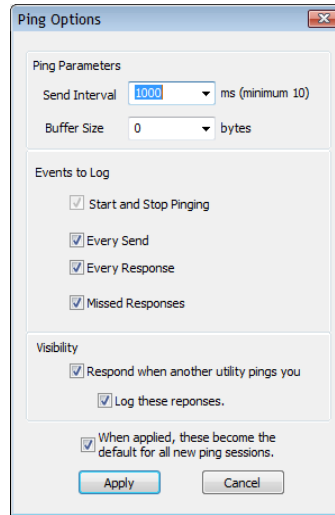

Parameter	Description
Send Interval	Specifies the time between ping signals in milliseconds. The minimum interval is 10 ms.
Buffer Size	Specifies the buffer size in bytes (the number of bytes sent on the ping).
Start and Stop Pinging	Select this check box to log the beginning and ending of the ping session.
Every Send	Select this check box to log every ping signal sent.
Every Receive	Select this check box to log every ping response received.
Missed Responses	Select this check box to log every missed ping response (when a device does not respond to a ping signal).
Respond when another utility pings you	Select this check box to reply to a ping request from another device.
Log these responses	Select this check box to log each ping response sent to another device.
When applied, these become the default for all new ping sessions	Select this check box to use these settings for all future ping sessions with any device.

5.9 Viewing Network Data in the IH Browser

The IH Browser **INFO** feature allows you to monitor the network connections for the selected radio in either the List View or Topology View. The feature shows:

- Wireless clients attached to the radio.
- Information about devices detected via the Ethernet interface of the radio.
- The 802.11 Access Points that are detected by this particular radio.
- The active ports on the radio.

5.9.1 Viewing Wireless Clients in the IH Browser

The *Client List* dialog box can be opened to show information about wireless clients connected to the currently selected radio. Radios with wireless clients are identifiable as shown by the red outline in the List and Topology Views below.

- 1 In the IH Browser, select a radio in either the *List View* or *Topology View*.
- 2 From the **INFO** menu choose **WIRELESS CLIENTS**, or right-click the radio and choose **WIRELESS CLIENTS**.

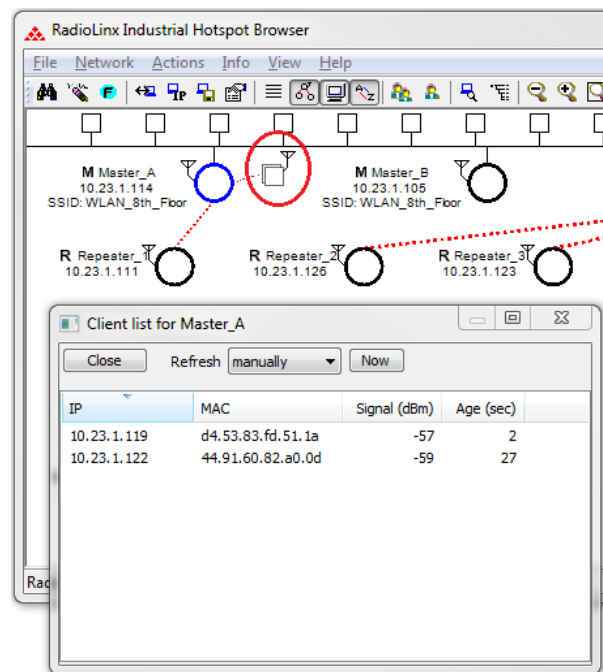

Parameter	Description
Refresh	Data refresh interval in seconds or minutes. Select MANUALLY to prevent the IH Browser from automatically updating the data.
Now	Click Now to manually update the data.
IP	Displays the IP addresses of the wireless clients connected to the radio.
MAC	Displays the MAC addresses of the wireless clients connected to the radio.
Signal (dBm)	Displays the signal strength from the wireless clients connected to the radio.
Age (sec)	Displays the age of the connection to the wireless clients connected to the radio (the amount of time since a packet has been received from that device).

5.9.2 Viewing Ethernet Nodes in the IH Browser

The *Ethernet Node List* dialog box shows information about devices detected by the Ethernet interface to the currently selected radio.

- 1 In the IH Browser, select a radio in either the *List View* or *Topology View*.
- 2 From the **INFO** menu choose **ETHERNET NODES**, or right-click the radio and choose **ETHERNET NODES**.

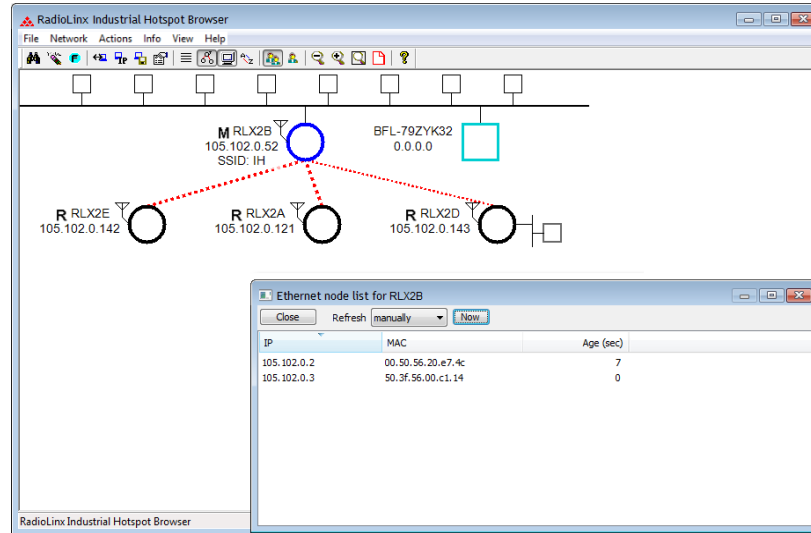

Parameter	Description
Refresh	Specifies the data refresh interval in seconds or minutes. Select MANUALLY to prevent the IH Browser from automatically updating the data.
Now	Click Now to manually update the data.
IP	Displays the IP addresses of the wireless clients connected to the selected radio.
MAC	Displays the MAC addresses of the wireless clients connected to the selected radio.
Age (sec)	Displays the age of the connection to the wireless clients connected to the selected radio (the amount of time since a packet has been received from that device).

5.9.3 Viewing the Scan List in the IH Browser

The *Scan List* dialog box shows all 802.11 Access Points known to the selected radio on this channel (through beacons), even if the Access Point is not linked to the radio (has a different SSID or uses different encryption). See *Detecting 802.11 Access Points* (page 29).

Note: This list shows some of the same information available in the *Available Parents* table in the web interface. See *Viewing Available Parents for a Radio* (page 61).

- 1 In the IH Browser, select a radio in either the *List View* or *Topology View*.
- 2 From the **INFO** menu choose **SCAN LIST**, or right-click the radio and choose **SCAN LIST**.

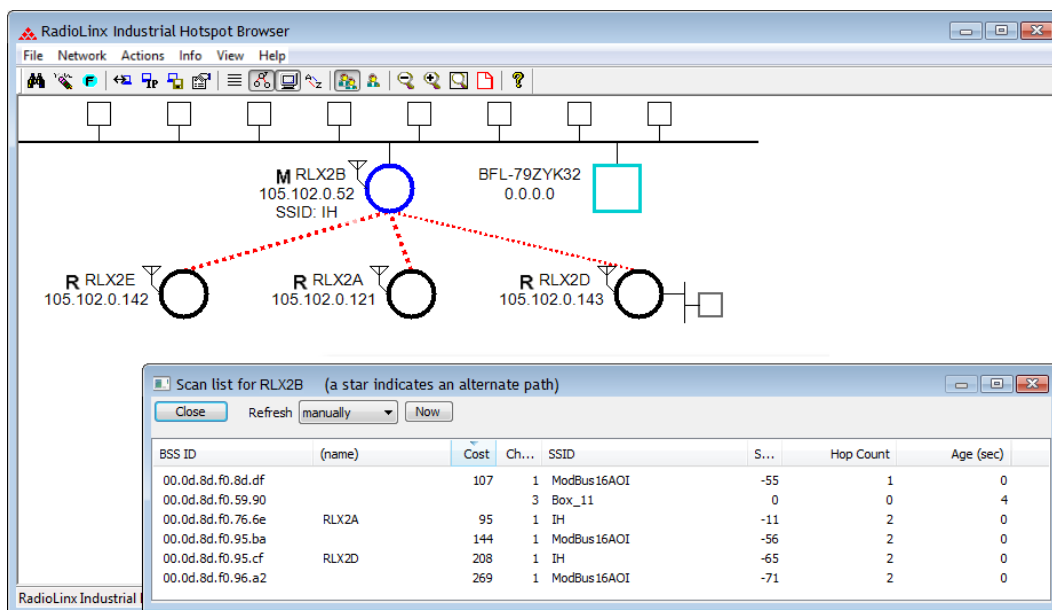

List entries marked with an asterisk * indicate that the entry is an alternate path, which you can also see if you select the **Parents** button from the toolbar in the *Topology* view (blue lines link the radio to its alternate parents).

Parameter	Description
Refresh	Specifies the data refresh interval in seconds or minutes. Select MANUALLY to prevent the IH Browser from automatically updating the data.
Now	Click Now to manually update the data.
BSS ID	Displays the Basic Service Set Identifier. This is the MAC addresses of the wireless clients known to the selected radio.
(name)	The name for RLX2-IHx series radios.

Parameter	Description
Cost	Displays the calculated parent selection cost. The radio evaluates the link it has to its parent once per second to determine if this link is the best parent to use. The radio calculates the cost for each entry. The cost calculation is based not only on the strongest signal, but on several other factors to provide optimum network communication.
Channel	The radio channel on which the device is transmitting. The channel list indicates the channel number as well as the frequency (2.4 GHz or 5 GHz bands). Important: The RLX2-IHx series radio is supplied with a dual-band antenna that supports both frequency ranges. If you use a different antenna with the RLX2-IHx series radio, you must choose a channel and frequency range supported by the antenna. See Appendix G - Antenna Configuration (page 215).
SSID	Displays the network name (Service Set Identifier) of the Ethernet device to which the radio is connected. The radio name appears for RLX2-IHx series radios.
Signal (dBm)	Displays the strength of the signal from the wireless clients connected to the selected radio.
Hop Count	Displays the number of hops to the Master device. A value of 0 (zero) appears for non-ProSoft Technology devices.
Age (sec)	Displays the age of the connection to the wireless clients connected to the selected radio (the amount of time since a packet has been received from that device).

5.9.4 Viewing the Port Table in the IH Browser

The *Port List* dialog box shows all active ports on the selected radio.

- 1 In the IH Browser, select a radio in either the *List View* or *Topology View*.
- 2 From the **INFO** menu choose **PORT TABLE**, or right-click the radio and choose **PORT TABLE**.

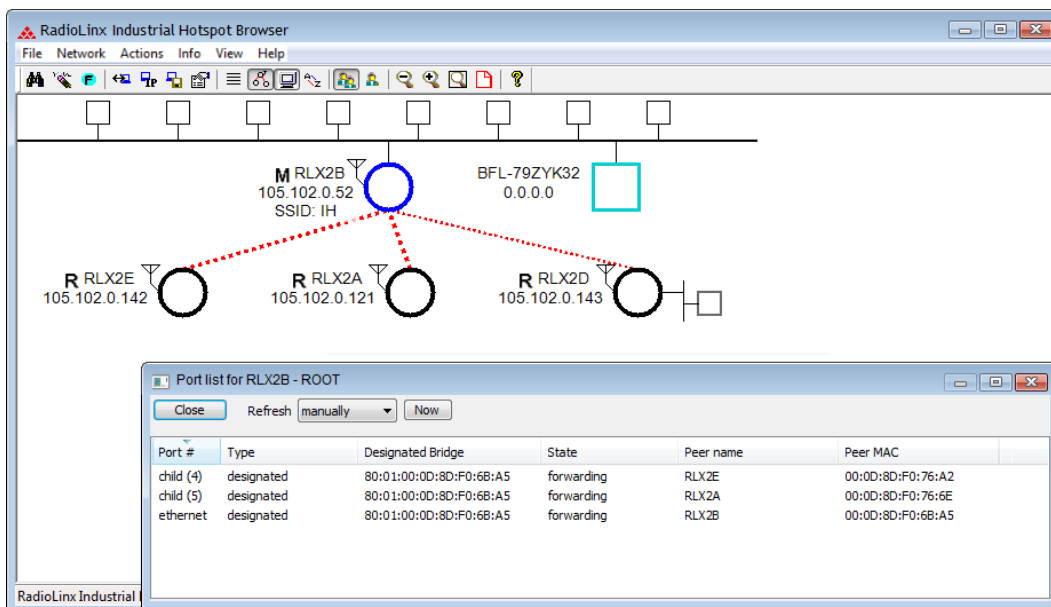

The port table is a list of all the active ports on the radio. Each RLX2-IHx series radio has up to 34 active ports: one Ethernet wired port, one parent radio frequency link, and up to 32 child radio frequency links.

Parameter	Description
Refresh	Specifies the data refresh interval in seconds or minutes. Select MANUALLY to prevent the IH Browser from automatically updating the data.
Now	Click Now to manually update the data.
Port #	Displays the selected radio's port number.
Type	Displays the type of the port (ETHERNET PORT , PARENT RF LINK , CHILD RF LINK).
Designated Bridge	The next bridge toward the Spanning Tree root for this port.
State	Displays the current Spanning Tree state of the port (BLOCKING , LEARNING , LISTENING , and FORWARDING). Forwarding packets can be transferred.
Peer Name	Displays the name of the Master radio if the current radio is a Repeater radio.
Peer MAC	Displays the MAC address of the Master radio if the current radio is a Repeater radio.

5.9.5 Viewing the Radio Event Log in the IH Browser

The *Event Log* dialog box displays the history of events that have been recorded by the currently selected radio. This can be useful for troubleshooting problems.

- 1 In the IH Browser, select a radio in either the *List View* or *Topology View*.
- 2 From the **INFO** menu choose **EVENT LOG**, or right-click the radio and choose **EVENT LOG**.

The Event Log shows the history of a particular radio. You can save the Event Log to a text file for troubleshooting purposes.

Note: The filter conditions that you set in the *Event Log Filter* dialog box affect both the display of events in the *Event Log* dialog box, and the events in the file you create when you click **SAVE**. See *Setting the Event Log Filter* (page 144).

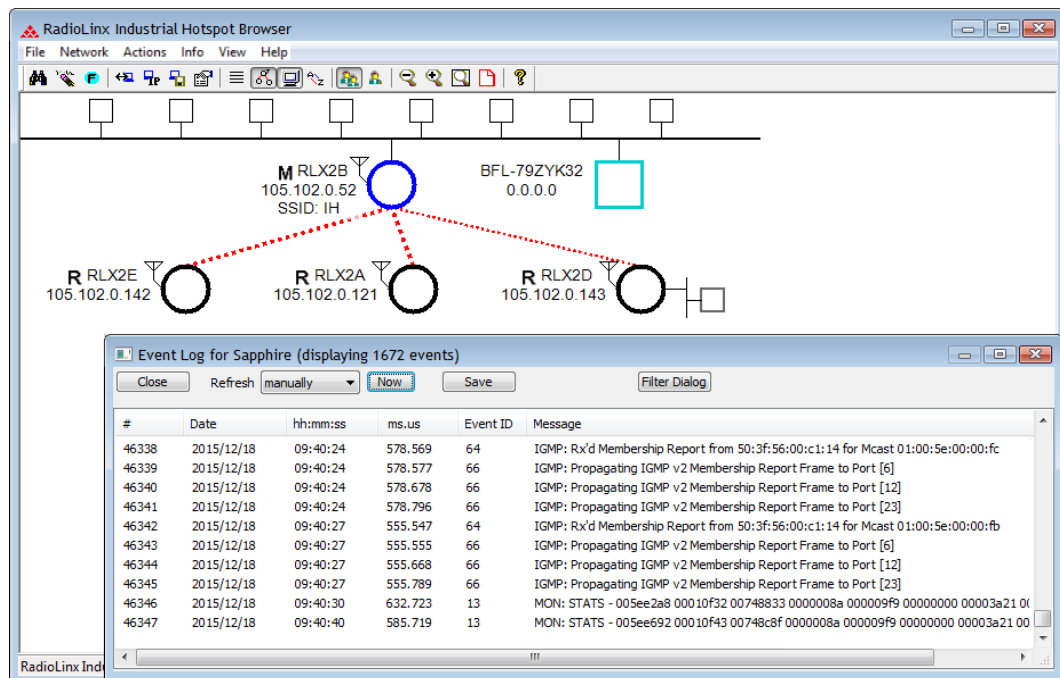

Parameter	Description
Refresh	Specifies the data refresh interval in seconds or minutes. Select MANUALLY to prevent the IH Browser from automatically updating the data.
Now	Click Now to manually update the data.
Save	Click SAVE to save the Event Log to a file for troubleshooting or sending to ProSoft Technology Technical Support.
Filter Dialog	Click FILTER DIALOG to change the Event Log filtering to show or hide certain events. See <i>Setting the Event Log Filter</i> (page 144).

Setting the Event Log Filter

The *Event Filter* dialog box allows you to include or exclude specific event types from the Event Log. The filter conditions that you set in this dialog box affect both the display of events in the *Event Log* dialog box, and the events in the file you create when you click **SAVE** in the *Event Log* dialog box.

Note: The filter conditions are reset to the default state (include all events) when you close the *Event Log* dialog box.

- 1 In the IH Browser, click on a radio in either the *List View* or *Topology View*.
- 2 From the **INFO** menu choose **EVENT LOG**, or right-click the radio and choose **EVENT LOG**.
- 3 In the *Event Log* dialog box, click **FILTER**.
- 4 Double-click on an event in the **EVENT LIST** to add it to the **SELECTED EVENTS** list. An asterisk (*) appears next to the event types in the Selected Events list. You can double-click on the event in the **EVENT LIST** a second time to remove it from the **SELECTED EVENTS** list.
- 5 Use the **EVENTS SHOULD BE** parameters to include only the selected events, or exclude the selected events.

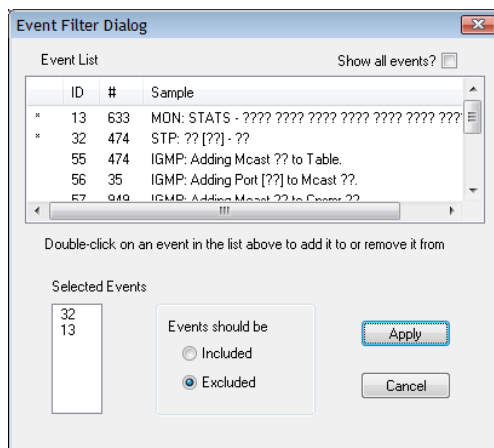



Parameter	Description
Event List	Displays a list of different types of events in the log, sorted by EVENT ID . By default, this list only includes events types that are in the radio's Event Log. <ul style="list-style-type: none"> ▪ Double-click an event type to add it to the Selected Events list. ▪ Double-click the event type again to remove it from the Selected Events list.
Show all events	Select this check box to show all event types, even if the type is not in the radio's Event Log.
Selected Events	Displays the list of selected event types.
Events should be	Specifies whether to include only the selected events, or exclude them. INCLUDED - Show only the selected events in the Event Log. EXCLUDED - Show all events in the Event Log except the selected events.

5.9.6 Viewing Parent Radios in the IH Browser

You can show the current Parent radio or all possible alternate Parent radios for the Repeater radios in the *Topology View*.

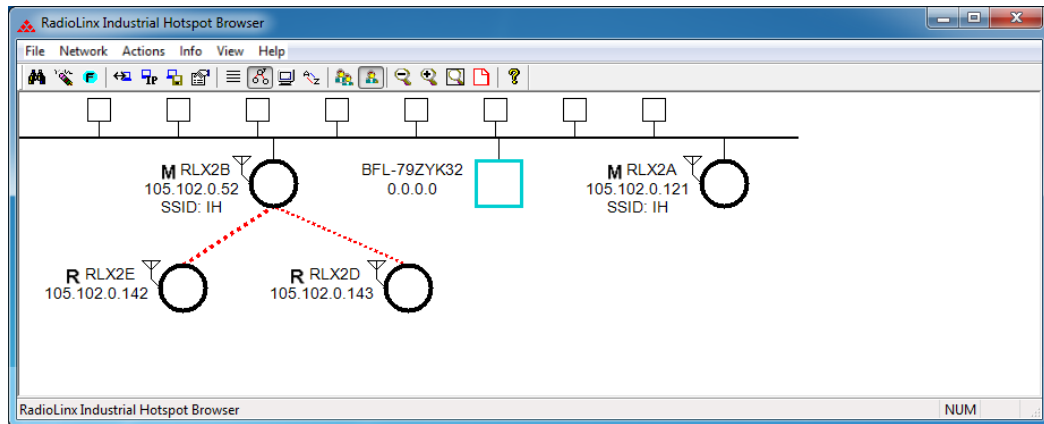
-  The *Show Selected Parents* button (or from the **VIEW** menu choose **SHOW PARENTS - ONE**) shows the link from Repeater radios to their current Parent radio in red.



-  The *Show All Parents* button (or from the **VIEW** menu choose **SHOW PARENTS - ALL**) shows links to alternate Parent radios in blue (If the Repeater radios can detect other radios in the network). This gives a graphical representation of the number of alternate paths available to a radio should its parent link go down.

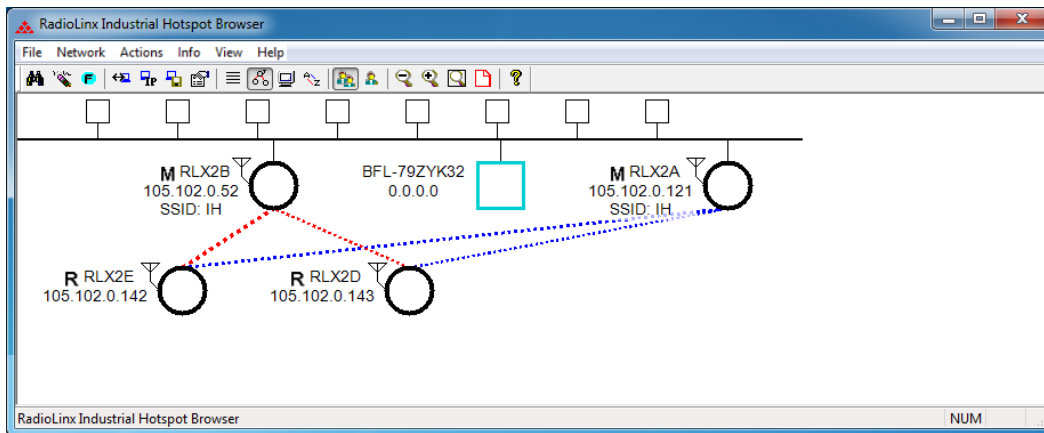

Note: You can also display a detailed list of each of the alternate Parent radios right-clicking a radio and choosing **SCAN LIST**. This list shows the RLX2-IHx series radios in the same network and all 802.11 Access Points on other networks. See *Viewing the Scan List in the IH Browser* (page 140).

5.10 Extracting Serial Logs from RLX2-IHx Radios

This feature allows you to simultaneously retrieve the serial log from multiple RLX2-IHx devices, and for an extended period of time. The serial logs can be used to analyze performance and aid in debugging.

The *Serial Logging Dialog* window can be opened by clicking on **NETWORK > SERIAL LOGGING**, or by clicking the **LOGGING** icon in the shortcuts bar.

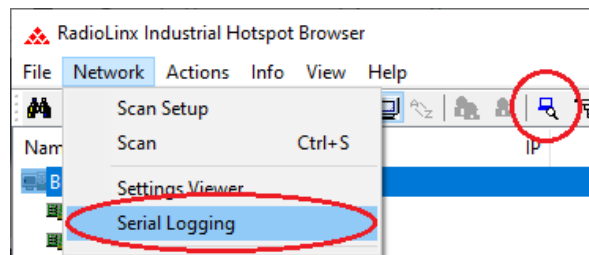

5.10.1 Serial Logging Dialog

When the *Serial Logging Dialog* window is opened, all detected RLX2-IHx devices in the network are listed. By default, all of the devices are selected to be part of the logging session. The *Monitor SSID* parameter is set to **Custom** as shown in the figure below.

Note: Only devices that are on the same subnet as the IH Browser PC will be able to participate in the logging session.

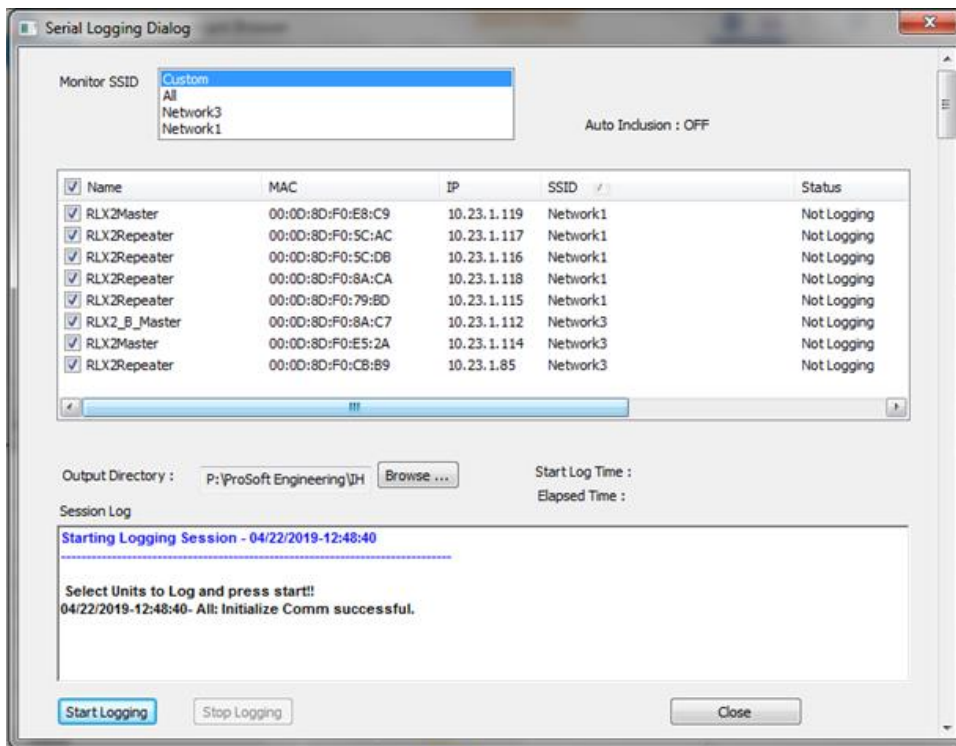

Monitor SSID

The *Monitor SSID* parameter has three options to select which RLX2-IHx's to be included in the logging session:

Monitor SSID option	Description
Custom	Manually selects each RLX2-IHx from the list to be included in the logging session
All	Selects all RLX2-IHx's in the list
Specific SSID	Selects the RLX2-IHx's by SSID

The columns are sortable by clicking on the column header. You can also utilize a group selection by using the standard 'Shift' key method.

The *All* and *Specific SSID* options automatically enable the *Auto Inclusion* feature. This adds an RLX2-IHx that is discovered by the IH Browser after a logging session has started. For the *Specific SSID* option, it must also have the same SSID that was selected.

The *Custom* option disables the *Auto Inclusion* feature and only the selected RLX2-IHx's will be included.

Output Directory

Select the file location to store the *Serial Logging Dialog* files by clicking on the **BROWSE** button in the *Output Directory* parameter.

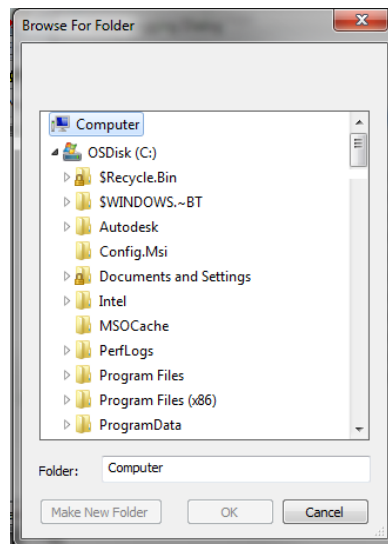
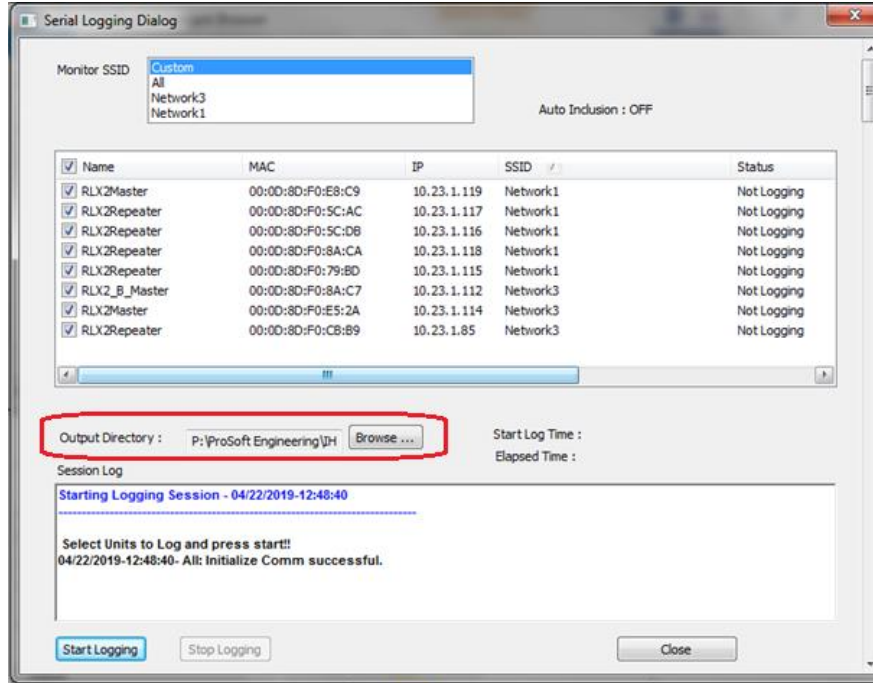

Within the base output directory, a separate subdirectory of active logs for each 24 hour day is created (mm.dd.yyyy).

Session Log

The *Session Log* is located at the bottom of the *Serial Logging Dialog*. It contains a session log of all the events and state changes that took place during logging.

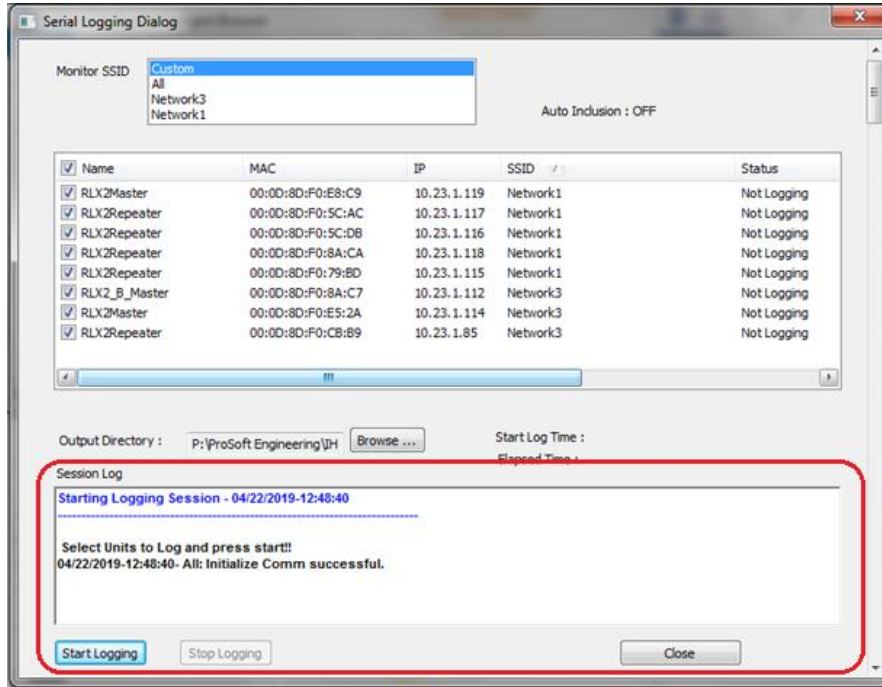

The *Session Log* is saved to the base *Output Directory* with the following format:

session_mm.dd.yyyy-hh.mm.ss.txt

Example: session_03.06.2019-13.56.39.txt

The date and time in the session log name is the time that the Session was started (i.e. the Dialog was opened).

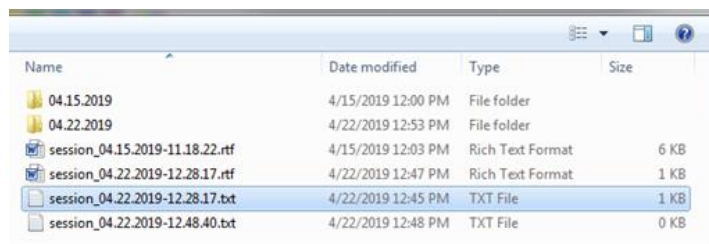

Within the daily directories the individual hourly logging file will be created with the following format:

APname-IPaddr-mm.dd.yyyy.hh.mm.ss.txt

Example: RLX2Master-10.23.1.111-03.01.2019.03.00.00.txt

The time in the first file's name will be the time of the oldest print in the backlog, downloaded after a telnet session is started. New files are created on the hour.

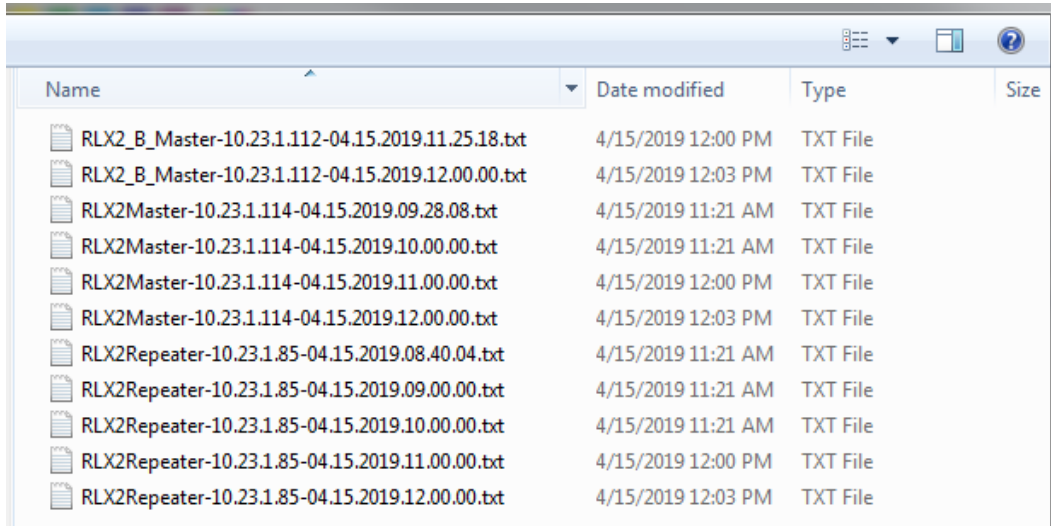

The screenshot shows a file explorer window with a table of files. The table has columns for Name, Date modified, Type, and Size. The files listed are log files for RLX2Master and RLX2Repeater, with names indicating IP address, date, and time. The dates are 4/15/2019 and the times range from 11:21 AM to 12:03 PM.

Name	Date modified	Type	Size
RLX2_B_Master-10.23.1.112-04.15.2019.11.25.18.txt	4/15/2019 12:00 PM	TXT File	
RLX2_B_Master-10.23.1.112-04.15.2019.12.00.00.txt	4/15/2019 12:03 PM	TXT File	
RLX2Master-10.23.1.114-04.15.2019.09.28.08.txt	4/15/2019 11:21 AM	TXT File	
RLX2Master-10.23.1.114-04.15.2019.10.00.00.txt	4/15/2019 11:21 AM	TXT File	
RLX2Master-10.23.1.114-04.15.2019.11.00.00.txt	4/15/2019 12:00 PM	TXT File	
RLX2Master-10.23.1.114-04.15.2019.12.00.00.txt	4/15/2019 12:03 PM	TXT File	
RLX2Repeater-10.23.1.85-04.15.2019.08.40.04.txt	4/15/2019 11:21 AM	TXT File	
RLX2Repeater-10.23.1.85-04.15.2019.09.00.00.txt	4/15/2019 11:21 AM	TXT File	
RLX2Repeater-10.23.1.85-04.15.2019.10.00.00.txt	4/15/2019 11:21 AM	TXT File	
RLX2Repeater-10.23.1.85-04.15.2019.11.00.00.txt	4/15/2019 12:00 PM	TXT File	
RLX2Repeater-10.23.1.85-04.15.2019.12.00.00.txt	4/15/2019 12:03 PM	TXT File	

5.10.2 Starting the Logging Session

In the example below, all RLX2-IHx's that use the **Network1** SSID will be logged.

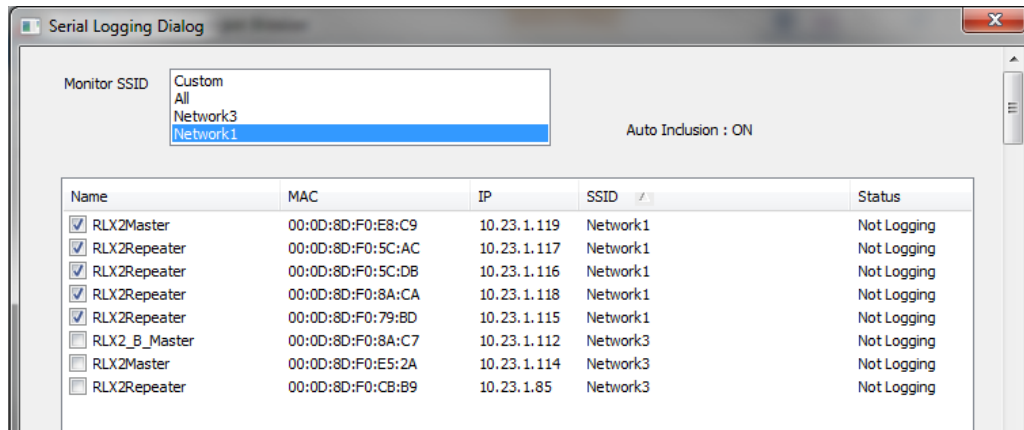

- 1 Click the **START LOGGING** button at the bottom of the dialog. The **STOP LOGGING** button activates once logging is started.
- 2 While logging, you can hide the *Serial Logging Dialog*. It can be brought forward by clicking on **NETWORK > SERIAL LOGGING**, or by clicking the **LOGGING** icon in the shortcuts bar.
- 3 When logging starts, the *Session Log* window lists all events and actions taken by the Logging Session.

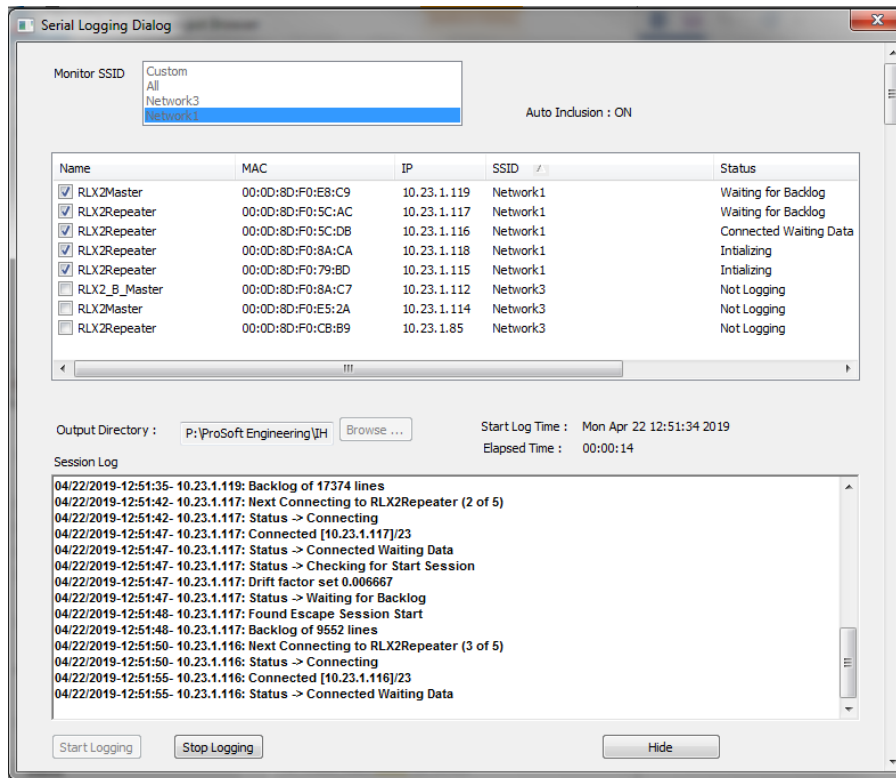

Each of the RLX2-IHx's in the session indicates one of the following states in the *Status* column:

State	Description
"Not Logging"	RLX2-IHx is not selected for logging.
"Initializing"	RLX2-IHx is selected for logging.
"Connecting"	Attempting to connect to the RLX2-IHx.
"Connected Waiting Data"	Connected to the RLX2-IHx and waiting to receive first data.
"Waiting for Backlog"	Has received data from the RLX2-IHx and now waiting to receive the accumulated backlog.
"Synced"	The backlog has been received and is fully time synced.
"Stopping"	The utility is stopping its logging session to the RLX2-IHx.
"Resyncing"	The time sync is being reestablished (occurs every hour).
"Reconnecting"	Attempting to reconnect to the RLX2-IHx.
"Failed"	RLX2-IHx experienced some failure, should attempt to reconnect.
"NoRx"	No Data received in the previous 5 sec period (not an error).
"Failed - Stopped"	The logging session to that unit has failed.

By design, the logging of each RLX2-IHx is staggered. Approximately one RLX2-IHx connects every 10 seconds. When an RLX2-IHx is first connected, there are up to 20,000 lines of historical backlog in the RLX2-IHx that will all be retrieved by the IH Browser.

Once this backlog is fully downloaded, the utility will calculate a time sync so that the log entries can be timestamped accurately:

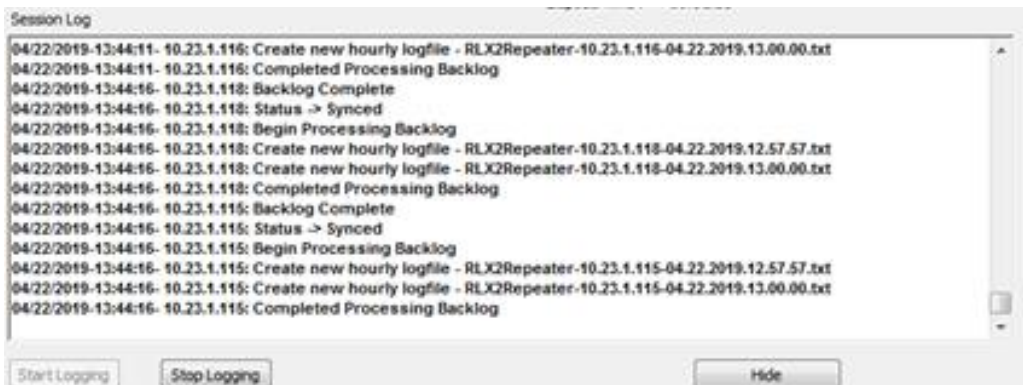

5.11 Settings Viewer

This feature allows you to view the current settings of RLX2 radios on the network. The RLX2-IHx must be running firmware RLX2_v0037F_R or later to use this feature.

The *Settings Viewer Dialog* window can be opened by clicking on **NETWORK > SETTINGS VIEWER**, or by clicking the **SETTINGS VIEWER** icon in the shortcuts bar.

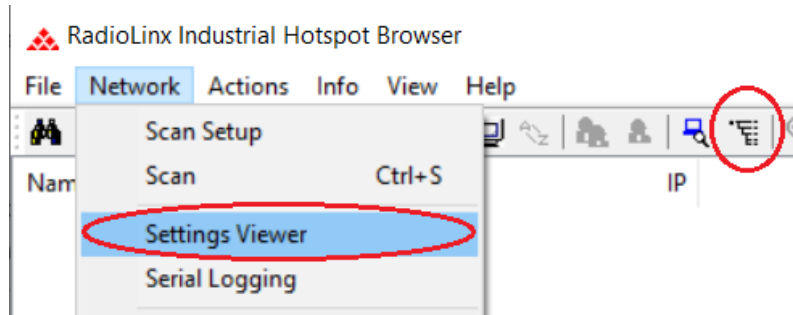

All detected radios on the network are listed in the *Settings Viewer Dialog* window. The view is updated automatically each time the IH Browser detects a new RLX radio on the network.

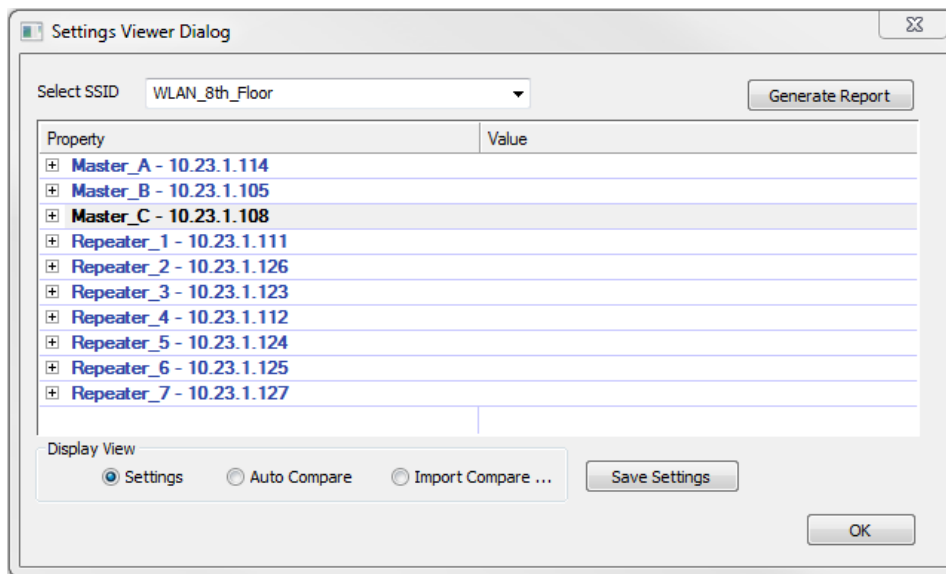

5.11.1 Select SSID

The *Select SSID* option filters the available radios of a common network, as identified by their SSID. The **ALL** option displays all radios detected, regardless of their SSID.

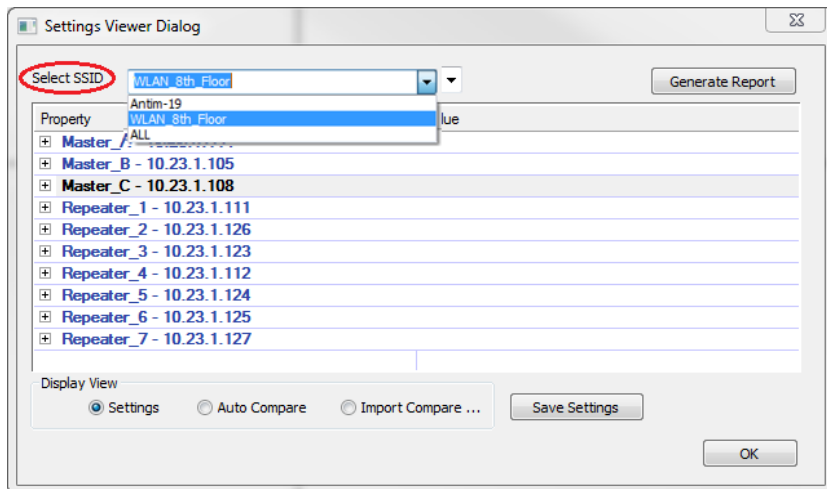

5.11.2 Display View

The *Settings Viewer Dialog* window has three different views:

- The **Settings** view displays the current setting values of any RLX2-IHx.
- The **Auto Compare** view compares the settings of the displayed units by grouping them and highlighting the differences.
- The **Import Compare** view compares the settings of the displayed units against settings that were previously saved using the **SAVE SETTINGS** button. This mode is useful in quickly determining if any unit has been inadvertently changed.

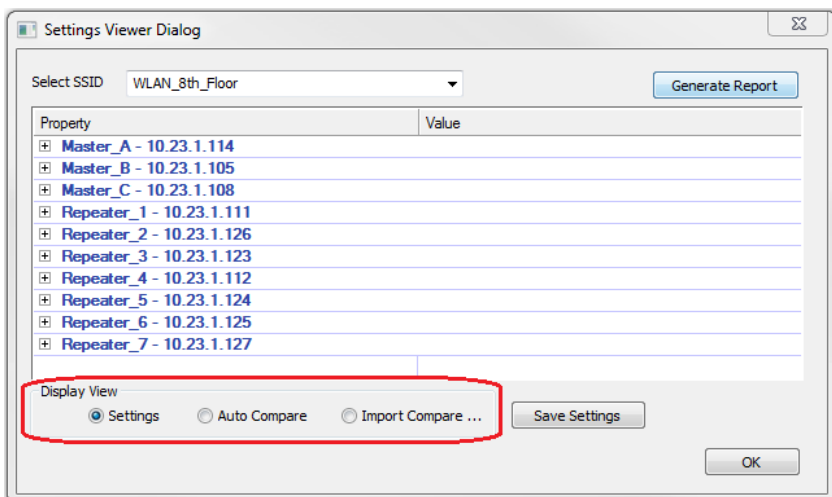

Settings View

The **Settings** view allows you to browse the current settings of an RLX2-IHx radio. Clicking on the “+” symbol expands the parameter list. The same can be achieved by double-clicking anywhere in a row that has a “+” symbol.

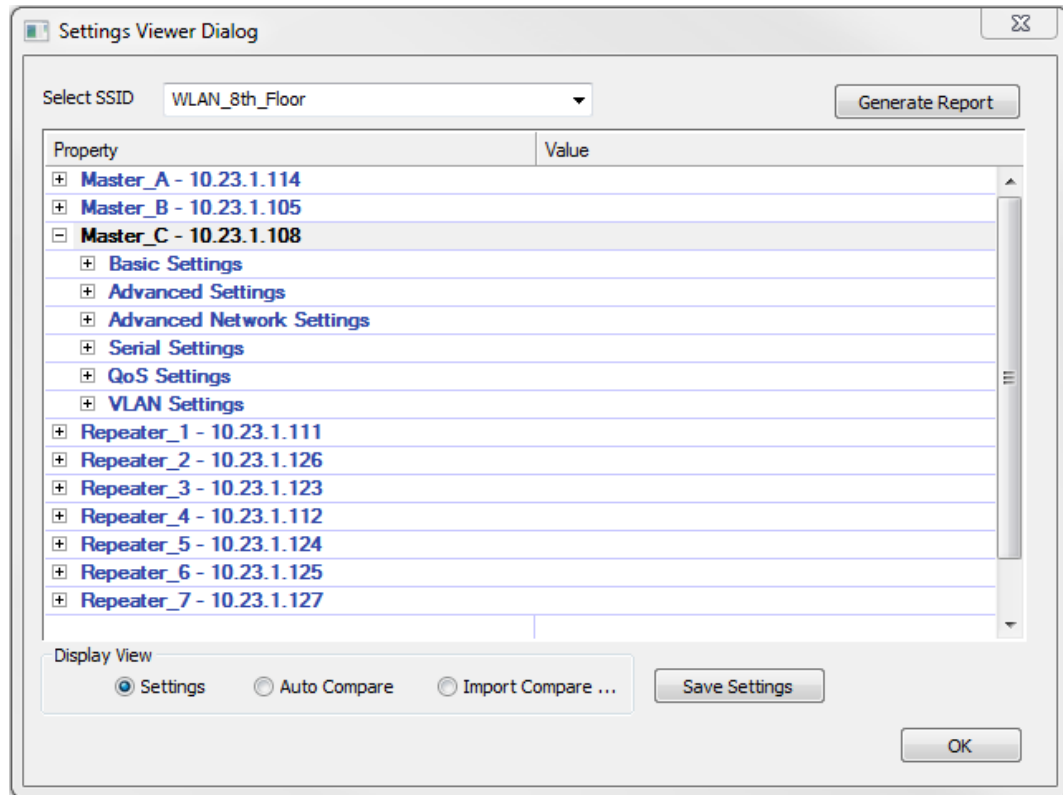

The sub-groups revealed match the tabs of the RLX2-IHx's web interface. See *Configuring Basic Settings* on page 66 for a description of the various RLX2-IHx settings in each of these groups.

Settings View Examples:

Basic Settings

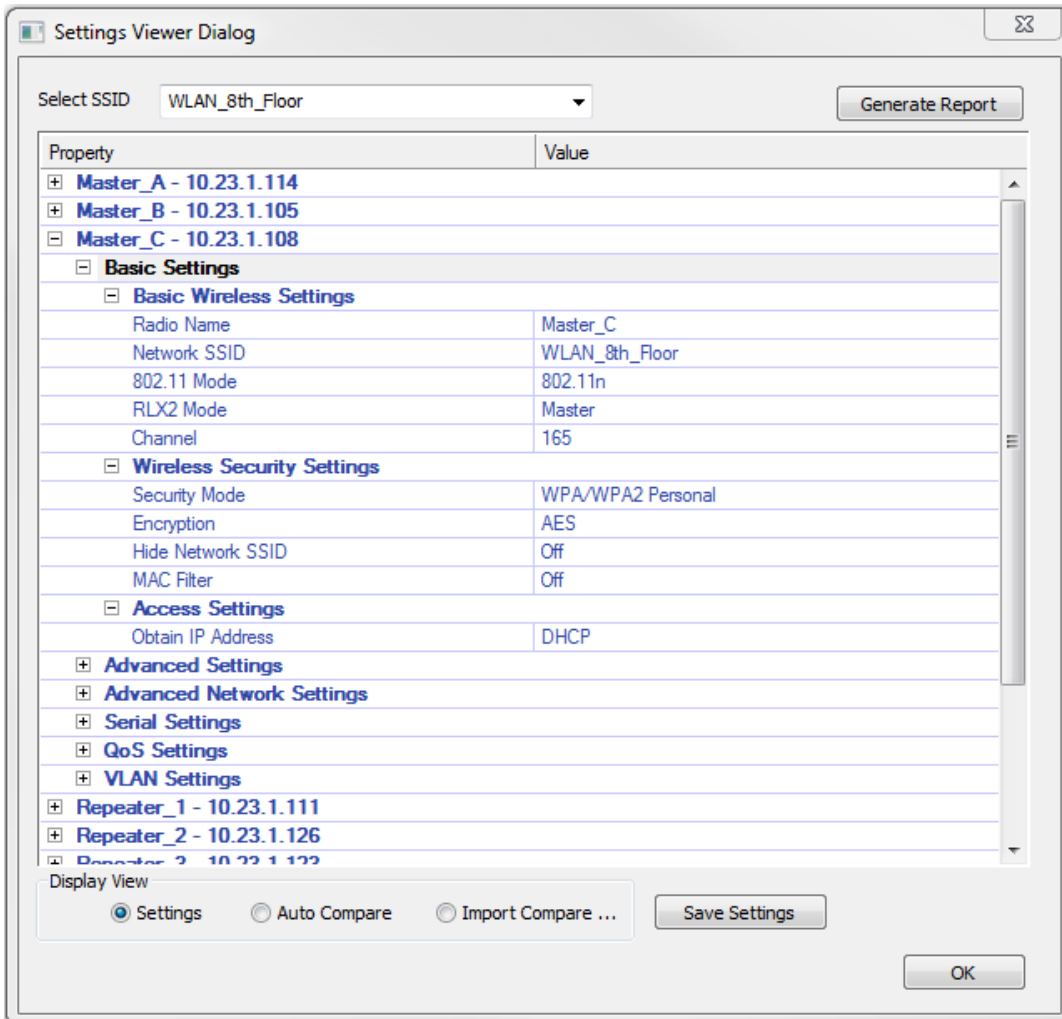

Advanced Settings

The screenshot shows a 'Settings Viewer Dialog' window with a 'Select SSID' dropdown set to 'WLAN_8th_Floor' and a 'Generate Report' button. The main area is a table with 'Property' and 'Value' columns. The table is expanded to show 'Advanced Settings' under 'Advanced Wireless Settings'. At the bottom, there are radio buttons for 'Display View' (Settings, Auto Compare, Import Compare ...) and 'Save Settings' and 'OK' buttons.

Property	Value
Master_A - 10.23.1.114	
Master_B - 10.23.1.105	
Master_C - 10.23.1.108	
Basic Settings	
Advanced Settings	
Advanced Wireless Settings	
Max Data Rate	MCS7
Min Data Rate	MCS0
Max Basic Rate	24 Mb/s
Optimize For	Manual
Immediate Beasts	On
Ignore Probes	On
Prosoft-only Clients	On
Range	Short
uAPSD Support	On
TX Attenuation (dBm)	0
Active Antennas	A B C
TX Stale Time(msec)	60000
Roam Control	
Disable FT	No
Disable Blackout	No
Parameters Advertised to Children	
None	0
Location Services	
AeroScout	Disabled
Personality Module	
SD Mode	Auto Write & Clone Enabled
Advanced Network Settings	
Serial Settings	
QoS Settings	
VLAN Settings	
Repeater_1 - 10.23.1.111	
Repeater_2 - 10.23.1.126	

Advanced Network Settings

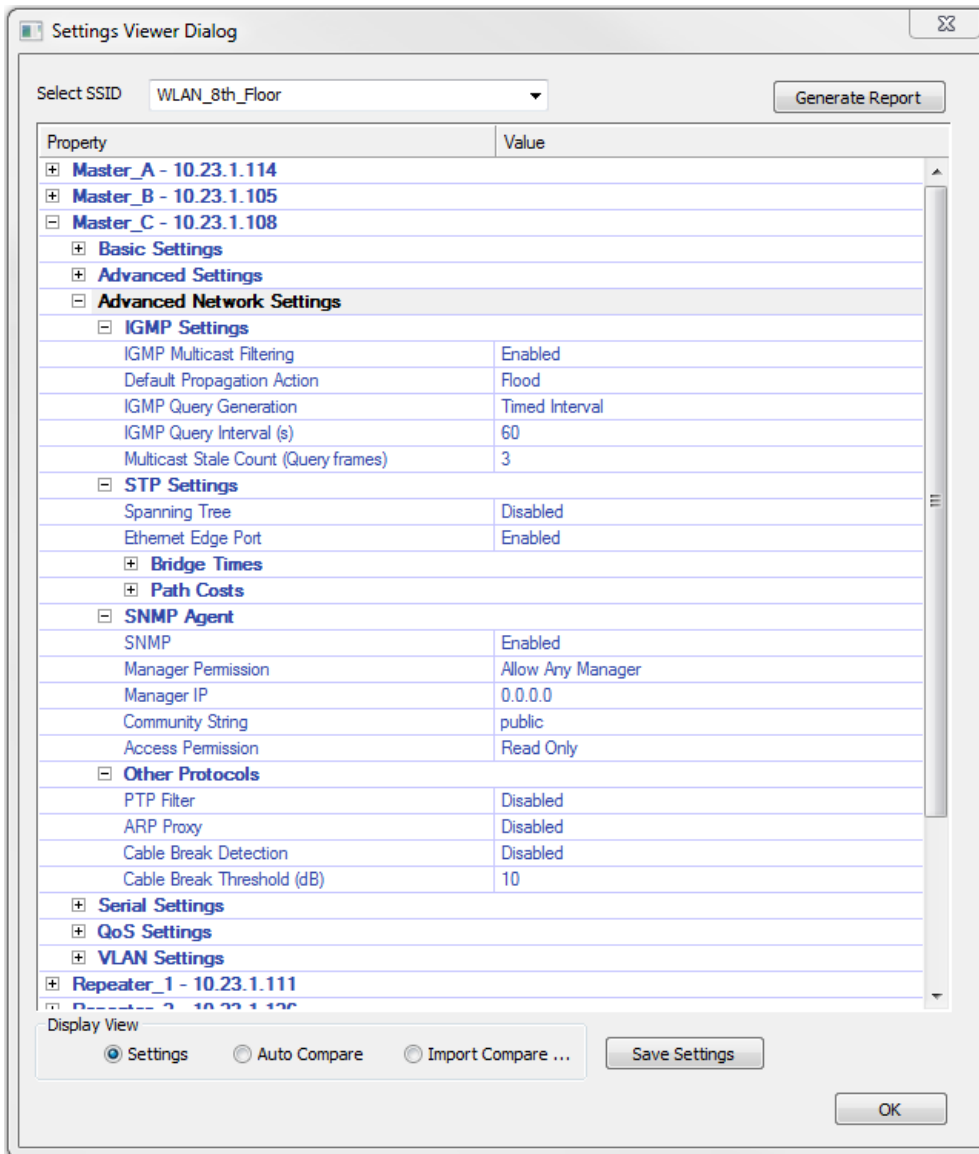

Auto Compare View

The *Auto Compare* view compares the settings of the displayed units by grouping them and highlighting the differences. Repeaters are only compared against other Repeaters, and Masters against other Masters.

The largest group of Repeaters and the largest group of Masters with common settings becomes the **Reference**. The differences between the Repeaters/Masters and their respective References are displayed.

The example below shows that all units have the same settings. All Repeaters are a part of the Reference Repeater group and all Masters are a part of the Master Reference group.

You can browse the settings by expanding (+) the *Reference xxx Settings* groups.

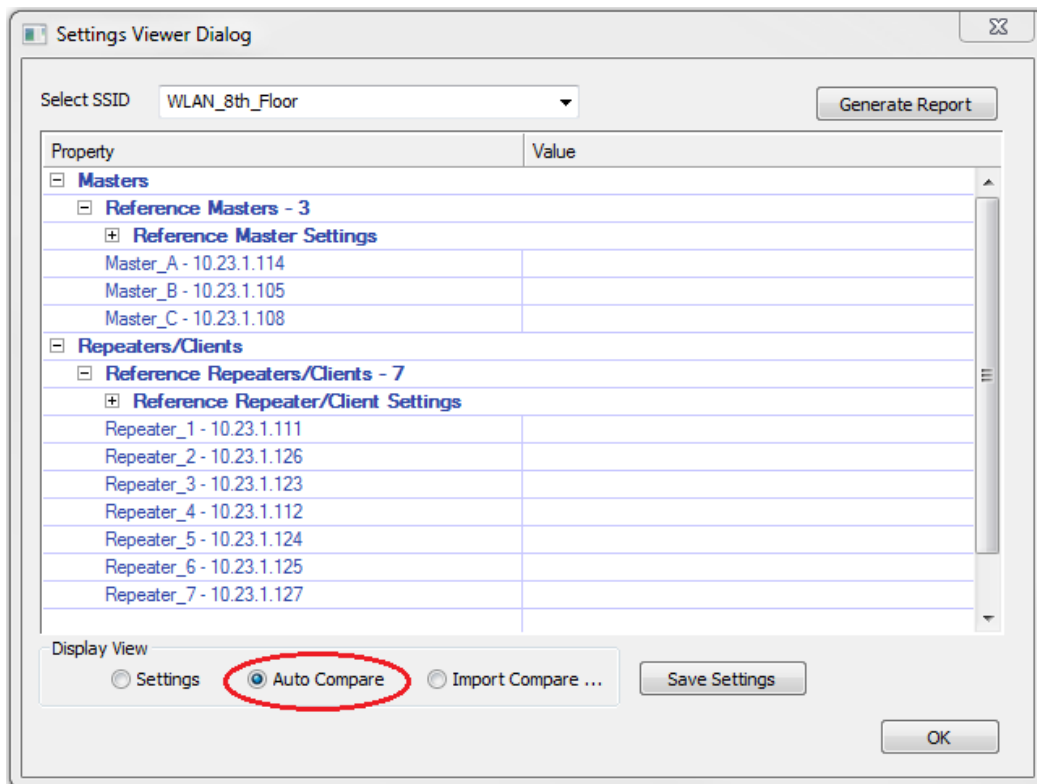

The example below shows three Repeaters that have setting differences from the **Reference Repeaters**. Two of the Repeaters have the same differences and are displayed in their own group labeled **Group A**. Another Repeater has an additional difference from the **Reference Repeaters** and is labeled **Group B**. In these difference groups, only the settings that are different are shown and highlighted in red. Where possible, the Reference value for the setting is shown in brackets.

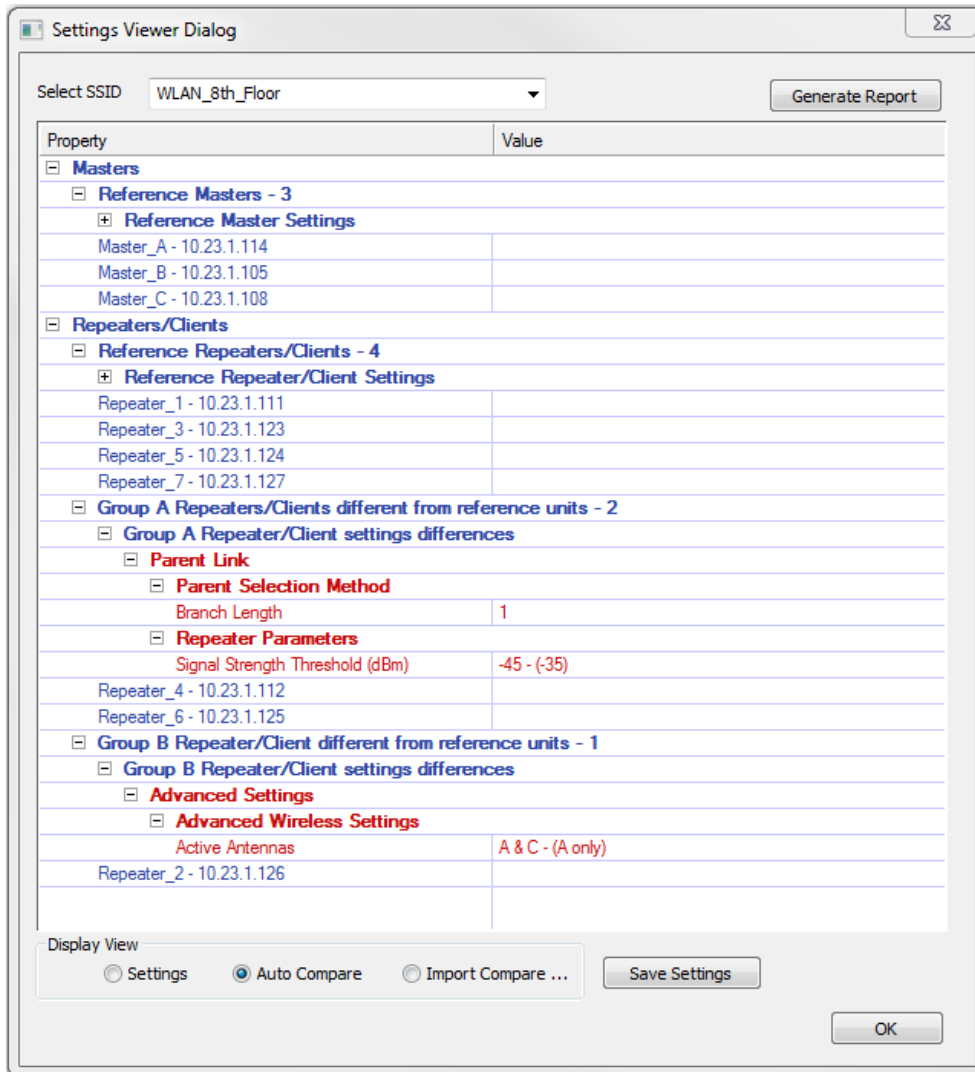

Import Compare

The *Import Compare* button allows you to select a previously saved *.settings* file.

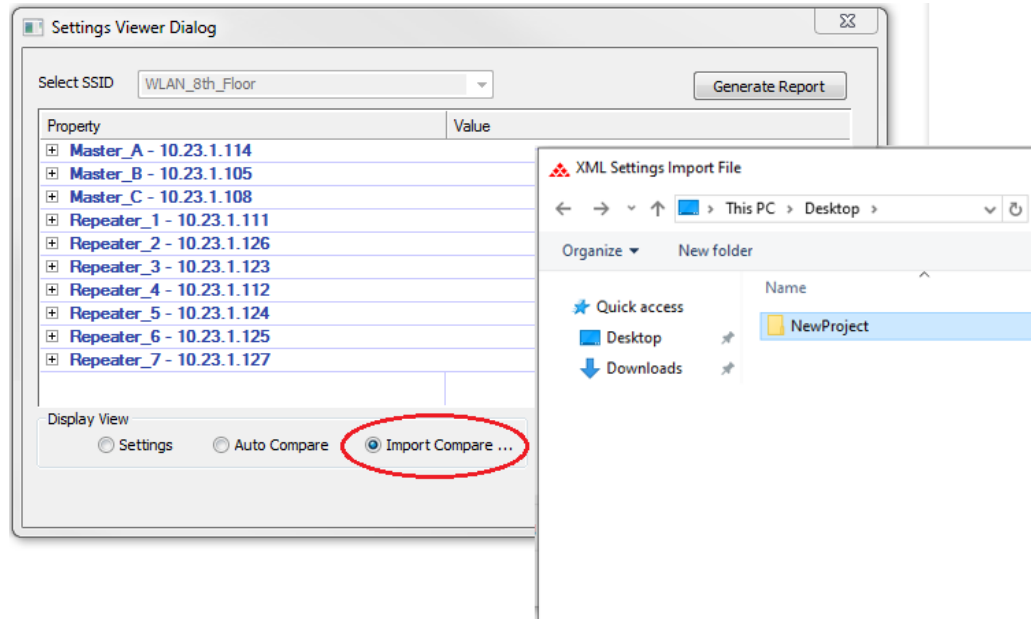

Once the file is selected, the settings of the RLX2-IHx's that have been discovered by the IH Browser are compared against the settings of the RLX2-IHx's in the imported settings file.

The comparison results are separated into 4 groups:

- **Units with Differences**
 - Units that have one or more settings that are different than the settings previously saved.
 - The setting differences are highlighted in red.
- **Missing units**
 - Units that were in the import file but not currently discovered by IH Browser.
- **No Change in Settings**
 - Units whose settings are exactly the same as in the imported settings file.
- **New Units**
 - Units that are currently present but are not in the imported settings file.

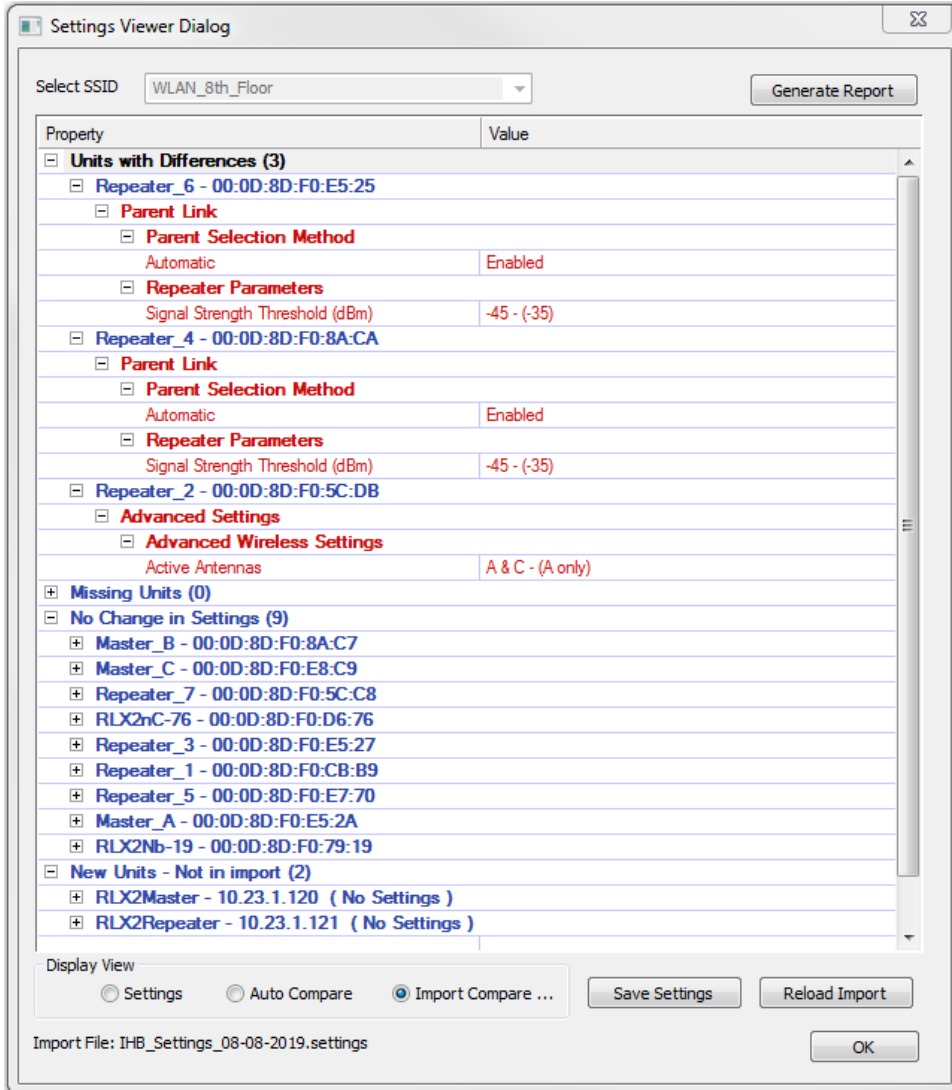

5.11.3 Save Settings Button

You can save the settings of all units that are known by the IH Browser so that they can be used as a reference when doing an “Import Compare”.

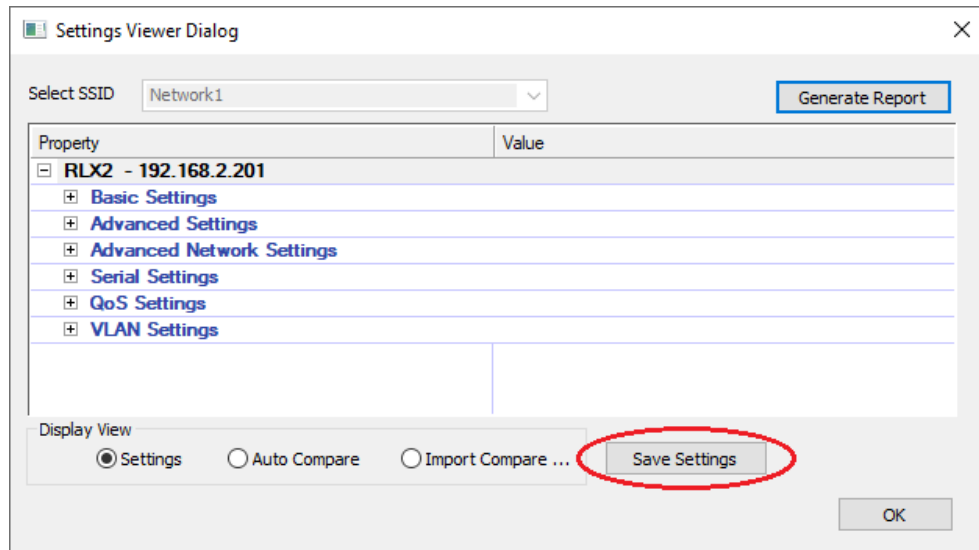

The **SAVE SETTINGS** button allows you to select the folder to save the `.settings` file. The default file name is: “IHB_Settings_dd_mm_year.settings”.

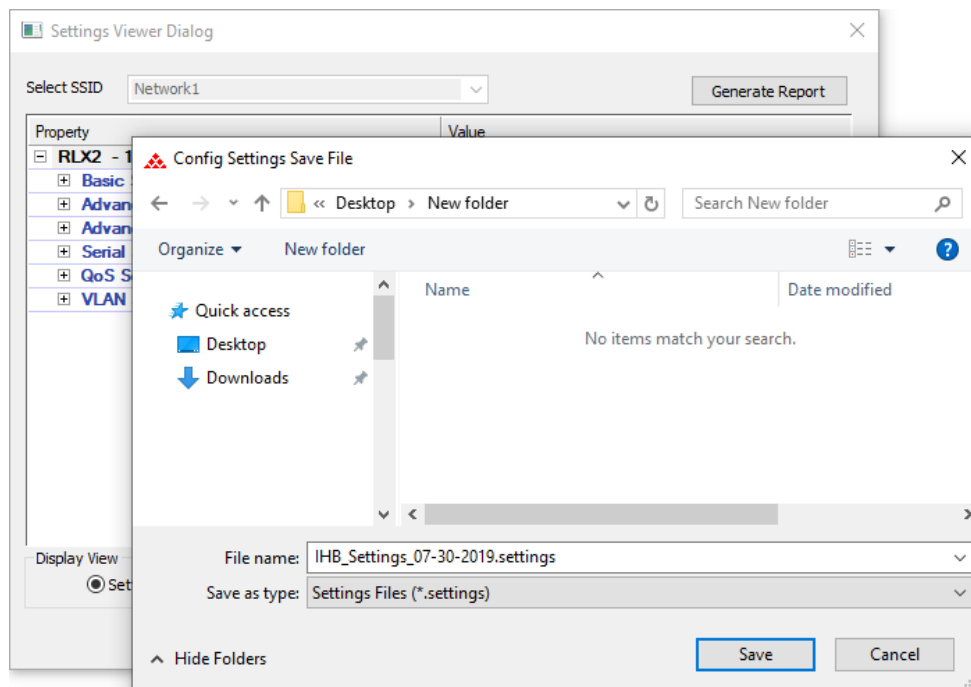

5.11.4 Generate Report Button

You can create a Word document that contains an expanded view of all the unit settings. Click on the **GENERATE REPORT** button.

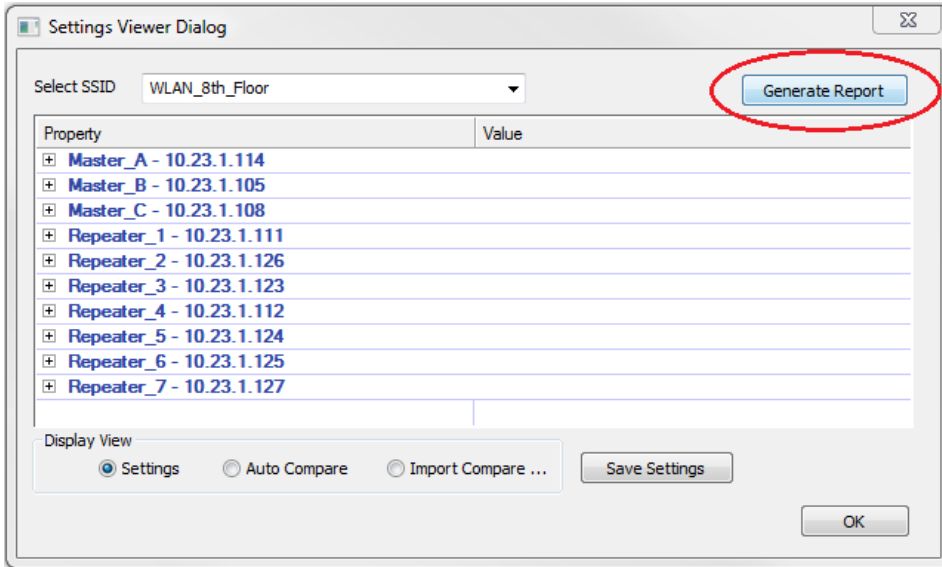

The **GENERATE REPORT** button allows you to select the folder to save the .rtf file. The default file name is: "IHB_Report_Settings_mm.dd.year_hh.mm.ss.rtf".

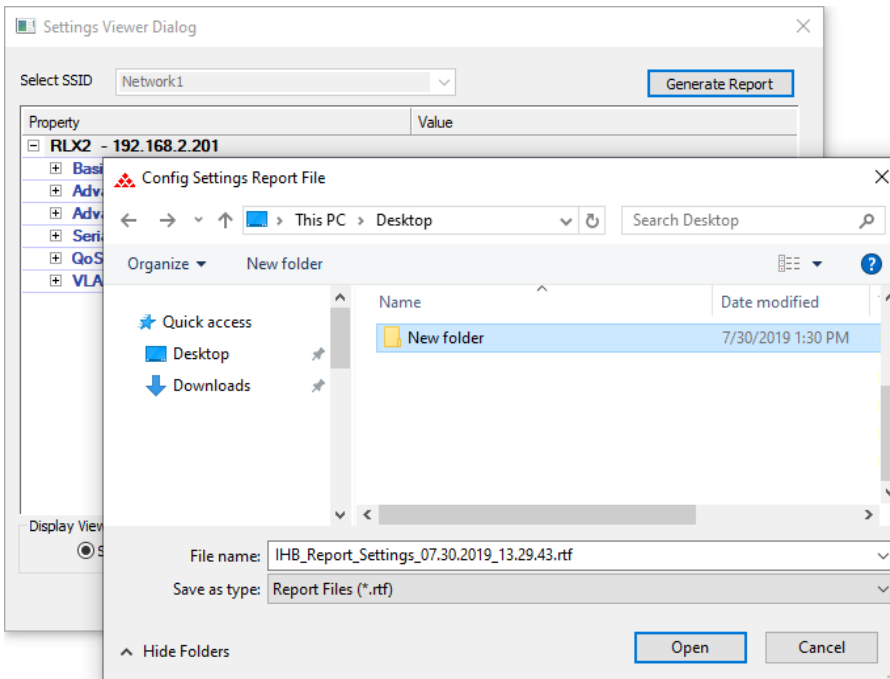

Report Example:

Display Settings Report

RLX2 - 192.168.2.201

Basic Settings

Basic Wireless Settings

Radio Name	: RLX2
Network SSID	: Network1
802.11 Mode	: 802.11n
RLX2 Mode	: Master
Channel	: 48

Wireless Security Settings

Security Mode	: WPA/WPA2 Personal
Encryption	: AES
Hide Network SSID	: Off
MAC Filter	: Off

Access Settings

Obtain IP Address	: DHCP
-------------------	--------

Advanced Settings

Advanced Wireless Settings

Max Data Rate	: 54 Mb/s
Min Data Rate	: MCS0
Max Basic Rate	: 24 Mb/s
Optimize For	: RLX2 Bridging
Immediate Bcasts	: On
Ignore Probes	: On
Prosoft-only Clients	: Off
Range	: Long
Range (km)	: 25
WAPSD Support	: On

5.12 Foreign AP Detection

This feature retrieves scan information from RLX2s that have responded to the IH Browser and appear in the main list view. This scan data can be used to detect the presence of rogue foreign Access Points that are operating on the same channel as the RLX2 units and can become a source of serious interference.

The IH Browser maintains a **whitelist** which allows the IH Browser to differentiate between detected APs that are meant to be present on that channel and APs that have come on-line in the facility either by error, or with malicious intent. A **foreign AP** is therefore defined as any AP that is not in the whitelist.

The *Foreign AP Detection* window can be opened by clicking on **NETWORK > FOREIGN AP DETECTION**, or by clicking the **FOREIGN AP DETECTION** icon in the shortcuts bar.

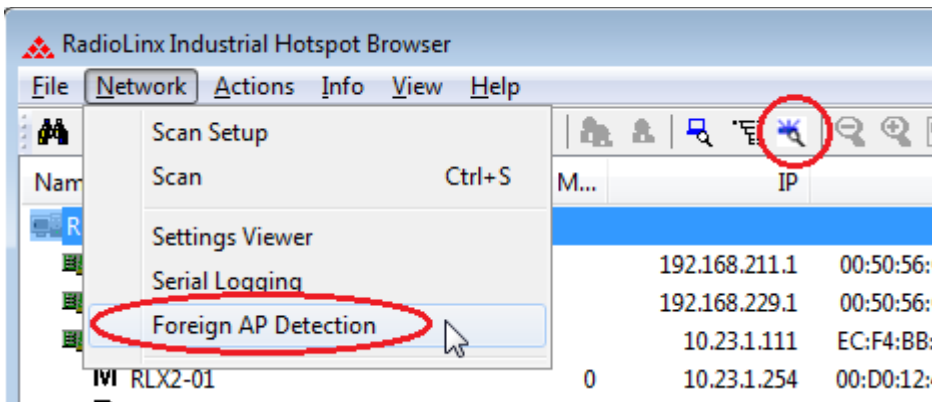

The dialog window initially opens in the disabled state as shown below. Clicking on the **ENABLE** button will enable the feature and the IH Browser will commence pulling scan information from the RLX2 units.

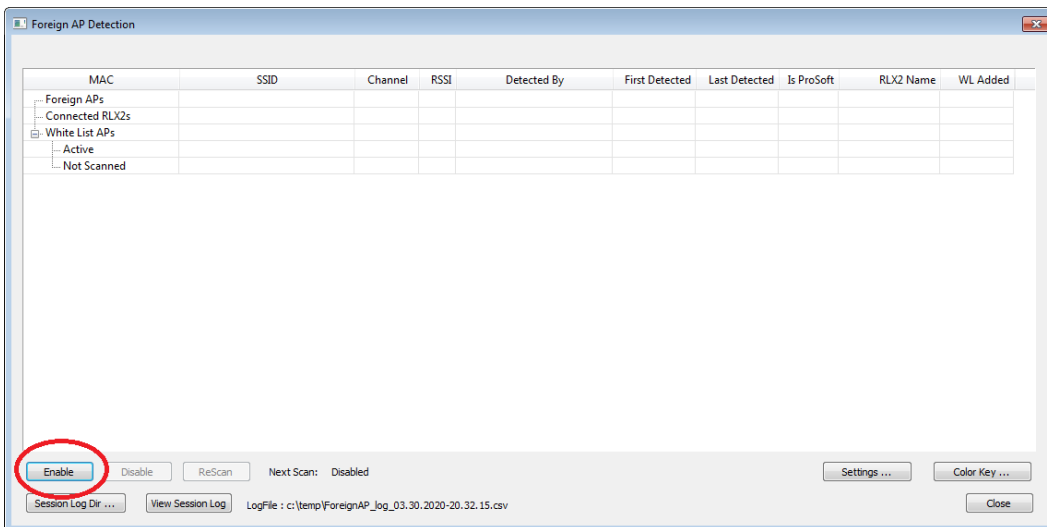

When first enabled the dialog populates the **Connected RLX2s** section of the display with all RLX2 units that are present in the main view of the IH Browser. These are the units that will be used as a source of Scan information to populate the other sections of the display.

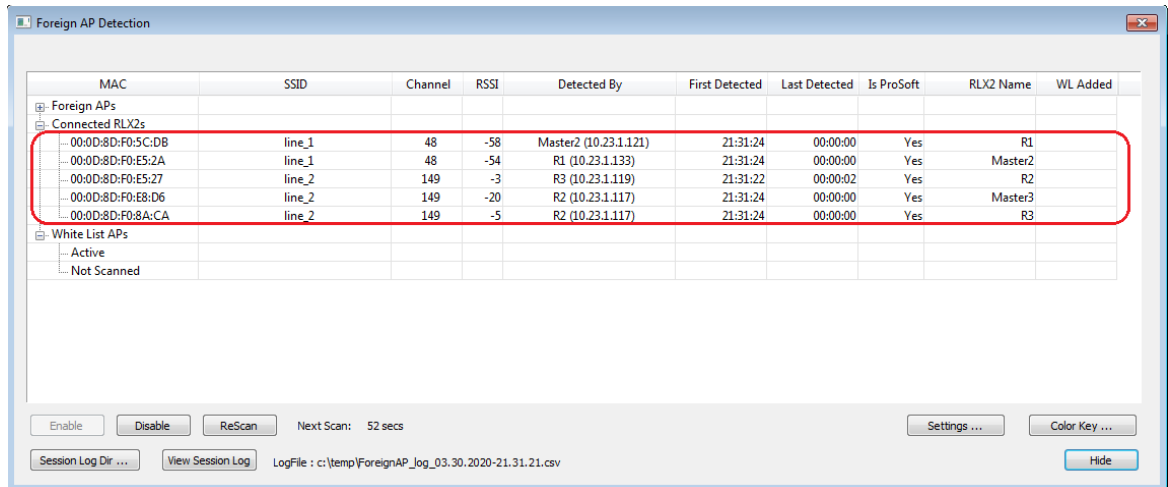

When any Foreign APs are detected the following pop up appears. Clicking the **OK** button will expand the **Foreign APs** section and display all APs that have currently been detected.

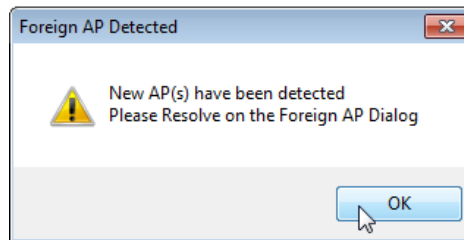

Clicking on any column heading in the Foreign AP Detection display will sort the table by that column to aid in viewing and interpreting the

MAC	SSID	Channel	RSSI
Foreign APs			
... 74:05:88:38:6C:04	Manrkemesh	149	0

In the Foreign AP Detection dialog shown in the example below the whitelist is currently empty as we have not yet assigned the known good APs to the whitelist. Therefore all detected APs are initially displayed in the Foreign APs section.

MAC	SSID	Channel	RSSI	Detected By	First Detected	Last Detected	Is ProSoft	RLX2 Name	WL Added
26:05:88:38:4C:CD		149	-75	R3 (10.23.1.119)	22:12:08	00:00:00	No		
26:05:88:38:4C:01		149	-70	R3 (10.23.1.119)	22:12:08	00:00:00	No		
26:05:88:38:4B:FD		149	-86	R2 (10.23.1.117)	22:12:08	00:00:00	No		
00:0D:8D:F0:C8:B6		149	-6	R3 (10.23.1.119)	22:12:05	00:00:03	Yes		
7C:5A:1C:44:73:21	COE Open	149	-70	Master1 (10.23.1.107)	22:12:07	00:00:01	No		
7C:5A:1C:44:73:D5	COE Open	149	-79	Master1 (10.23.1.107)	22:12:00	00:00:08	No		
86:5A:1C:44:73:21	COE_Enterprise	48	-75	Master1 (10.23.1.107)	22:12:08	00:00:00	No		
82:5A:1C:44:73:21	COESecure	149	-80	Master1 (10.23.1.107)	22:12:04	00:00:04	No		
82:5A:1C:44:73:D5	COESecure	149	-71	Master1 (10.23.1.107)	22:12:06	00:00:02	No		
00:0D:8D:F0:5C:C8	line_3	149	-19	Master3 (10.23.1.108)	22:12:08	00:00:00	Yes		
00:0D:8D:F0:E5:25	line_3	149	-15	Master3 (10.23.1.108)	22:12:08	00:00:00	Yes		
00:0D:8D:F0:E7:70	line_3	149	-10	Master3 (10.23.1.108)	22:12:08	00:00:00	Yes		
00:0D:8D:F0:E8:C9	line_3	149	-17	Master3 (10.23.1.108)	22:12:08	00:00:00	Yes		
00:0D:8D:F0:D6:77	line_3	48	-11	R1 (10.23.1.133)	22:12:08	00:00:00	Yes		
24:05:88:38:6C:04	Manrkemesh	149	-71	Master1 (10.23.1.107)	22:12:08	00:00:00	No		
24:05:88:38:4B:FD	Manrkemesh	149	-79	R3 (10.23.1.119)	22:12:08	00:00:00	No		
24:05:88:38:4C:CE	Manrkemesh	149	-75	R3 (10.23.1.119)	22:12:08	00:00:00	No		
24:05:88:38:6C:00	Manrkemesh	149	-71	R3 (10.23.1.119)	22:12:08	00:00:00	No		
6C:3B:6B:3F:DF:0F	MikroTik-3FDF0F	48	-50	Master1 (10.23.1.107)	22:12:08	00:00:00	No		

The Foreign AP Detection display columns

Column	Description
MAC	MAC address of the AP,
SSID	The SSID that the AP is advertising in its Beacon,
Channel	The channel number on which the AP was detected,
RSSI	The signal strength of the AP as measured by the detecting unit. Note: if more than one 'Connected RLX2s' the same AP the table will display the information from the unit that measured the highest RSSI.
Detected By	The name and IP Address of the Connected RLX2 that detected the AP with the strongest RSSI.
First Detected	The date/time that the AP was first detected by any Connected RLX2. Only the time is shown if the date is the same as the current date.
Last Detected	The elapsed time since information was last received for the AP. Can occur if an AP is powered down or moved out of range.
Is ProSoft	Indicates 'Yes' if the AP is a ProSoft RLX2, 'No' otherwise.
RLX2 Name	The name of the unit if it is an RLX2. This column will only contain a value in the 'Connected RLX2s' section.
WL Added	The time that an AP was added to the whitelist.

Right-clicking on any AP row in the view will present the action menu below. Only actions allowed or relevant are enabled with the others grayed out.

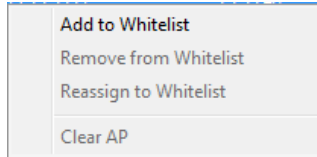

Foreign AP Detection

MAC	SSID	Channel	RSSI	Detected By	First Detected	Last Detected	Is ProSoft	RLX2 Name	WL Added
Foreign APs									
26:05:88:38:4C:CD		149	-75	R3 (10.23.1.119)	22:12:08	00:00:00	No		
26:05:88:38:6C:01		149	-70	R3 (10.23.1.119)	22:12:08	00:00:00	No		
26:05:88:38:4B:FD		149	-86	R2 (10.23.1.117)	22:12:08	00:00:00	No		
00:0D:8D:F0:C8:B6	-----	149	-6	R3 (10.23.1.119)	22:12:05	00:00:03	Yes		
7C:5A:1C:44:73:21	COE Open	149	-70	Master1 (10.23.1.107)	22:12:07	00:00:01	No		
7C:5A:1C:44:73:D5	COE Open	149	-79	Master1 (10.23.1.107)	22:12:00	00:00:08	No		
86:5A:1C:44:73:21	COE_Enterprise	48	-75	Master1 (10.23.1.107)	22:12:08	00:00:00	No		
82:5A:1C:44:73:21	COESecure	149	-80	Master1 (10.23.1.107)	22:12:04	00:00:04	No		
82:5A:1C:44:73:D5	COESecure	149	-71	Master1 (10.23.1.107)	22:12:06	00:00:02	No		
00:0D:8D:F0:5C:C8	line_3	149	-19	Master3 (10.23.1.108)	22:12:08	00:00:00	Yes		
00:0D:8D:F0:E5:25	line_3	149	-15	Master3 (10.23.1.108)	22:12:08	00:00:00	Yes		
00:0D:8D:F0:E7:70	line_3	149	-10	Master3 (10.23.1.108)	22:12:08	00:00:00	Yes		
00:0D:8D:F0:E8:C9	line_3	149	-17	Master3 (10.23.1.108)	22:12:08	00:00:00	Yes		
00:0D:8D:F0:D6:77	line_3	48	-11	R1 (10.23.1.133)	22:12:08	00:00:00	Yes		
24:05:88:38:6C:04	Mankemesh	149	-71	Master1 (10.23.1.107)	22:12:08	00:00:00	No		
24:05:88:38:4B:FD	Mankemesh	149	-79	R3 (10.23.1.119)	22:12:08	00:00:00	No		
24:05:88:38:4C:CE	Mankemesh	149	-75	R3 (10.23.1.119)	22:12:08	00:00:00	No		
24:05:88:38:6C:00	Mankemesh	149	-71	R3 (10.23.1.119)	22:12:08	00:00:00	No		
6C:3B:6B:3F:DF:0F	MikroTik-3FDF0F	48	-50	Master1 (10.23.1.107)	22:12:08	00:00:00	No		
Connected RLX2s									
White List APs									
Active									
Not Scanned									

Enable Disable ReScan Next Scan: 104 secs Settings ... Color Key ...

Session Log Dir ... View Session Log LogFile : c:\temp\ForeignAP_log_03.30.2020-22.12.05.csv Hide

5.12.1 Adding APs to the Whitelist

The previous SSID sorted list shows that there are 4 other systems on the channels of our network plus two single APs. In all cases the actions to take are as follows:

- If an AP or set of AP's belong to your organization and should be operating on the these channels, then they can be whitelisted.
- If an AP or set of AP's belong your organization but should not be operating on these channels, then your IT department should move them to a different channel.
- If an AP or set of AP's does not belong to your organization, then take steps to identify its location. If it's deemed legitimate (e.g. a neighbor's system) then whitelist, otherwise remove the AP.

In our example there are 6 sets of APs that have to be addressed.

- 1 This set of 3 APs has no SSID displayed which means the APs have 'hidden' their SSID. In this case the only identification that can be used to find these APs are their MAC addresses.
- 2 This "COE" system has 3 related SSIDs but have APs on both of our channels (48 and 149). Its RSSIs indicate that it is not very close to our system.
- 3 This "line_3" network is made up of ProSoft units. Since it did not appear in the list of "Connected RLX2s" it means that these units' Ethernet network is isolated from the Ethernet of line_1 and line_2 but within wireless range. In fact they are probably co-located as their RSSI is very strong.
- 4 The "Manrkemesh" system has 4 APs on channel 149. Given its RSSIs are very low this system is also not close by.

The AP with SSID "-----" is an RLX2 unit in Repeater mode but configured to not allow other Repeaters to connect to it (Allow Children set to NO).

To add an AP to the whitelist right-click on the AP and click on the "Add to Whitelist" option. Multiple APs can be first selected by holding the Shift or Cntl key in the normal Windows fashion. Then right click on the selected group and click on the Add to Whitelist option as shown below.

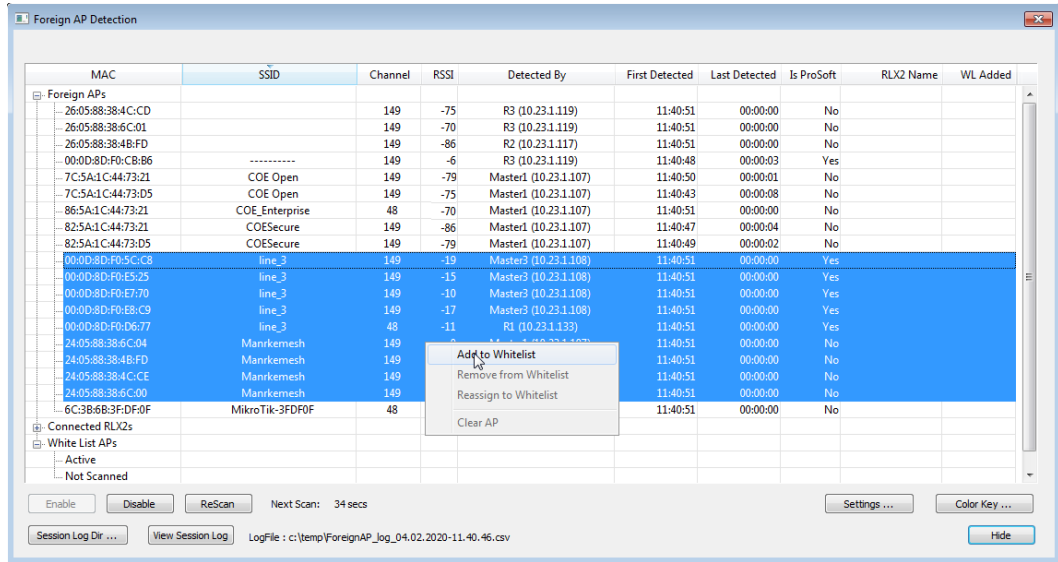

The selected APs now appear in the **White List APs** section as Active nodes. The WL Added column now shows the time that these APs were added to the whitelist.

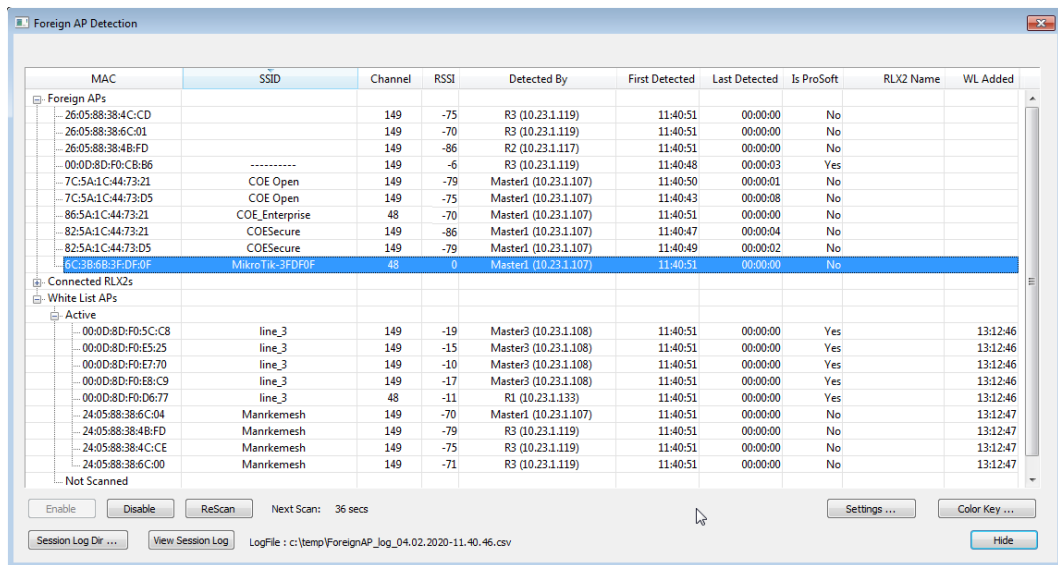

5.12.2 Removing APs from the Whitelist

If an AP is mistakenly added to the whitelist it can be removed by right-clicking on the AP's row and selecting the **REMOVE FROM WHITELIST** option.

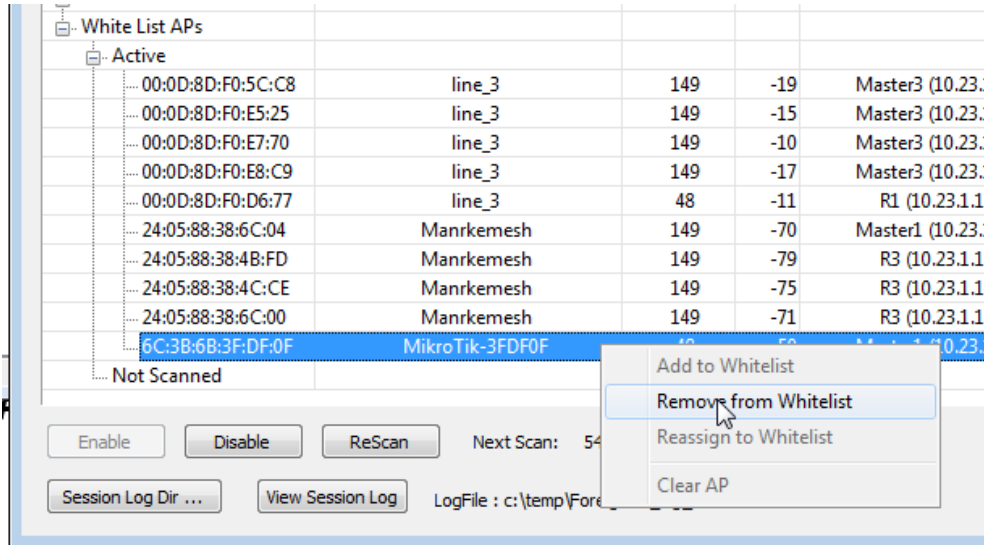

5.12.3 Forcing a Scan

The Foreign AP Detection window requests new scan data from the **Connected RLX2s** every 120 seconds by default. This value can be changed using the Settings dialog (see Section 5.12.4).

The time to the next scan event is shown in the display:

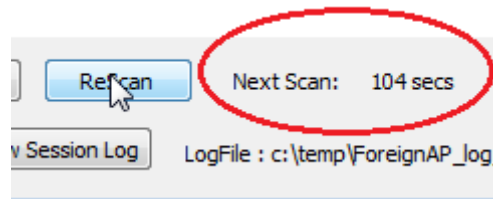

Clicking on the **RESCAN** button will initiate an immediate scan and the timer will reset to the scan interval value.

5.12.4 Foreign AP Detection Settings

Clicking on the Settings button in the Foreign AP Detection window opens a dialog box allowing the setting of Foreign AP Detection parameters.

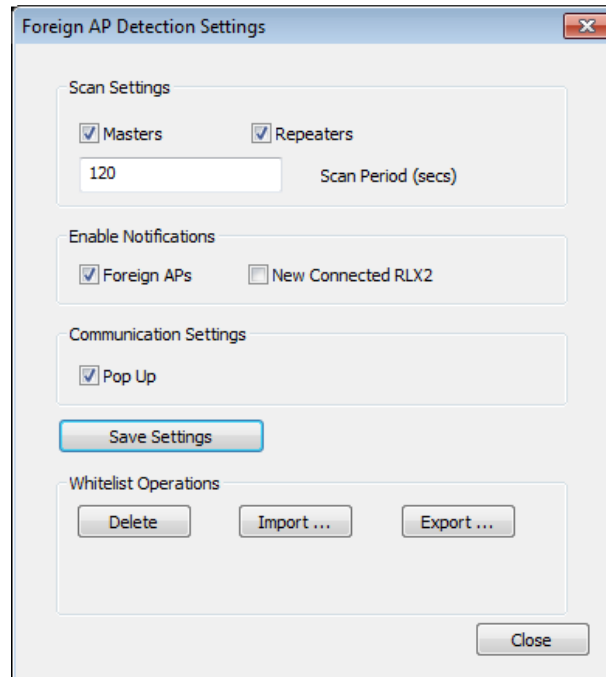
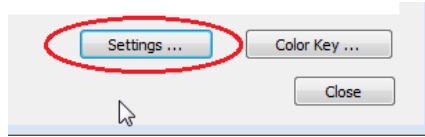

Scan Settings	Description
Masters	Check this checkbox to use all Masters in Connected RLX2s as a source of scan data.
Repeaters	Check this checkbox to use all Repeaters in Connected RLX2s as a source of scan data.
Scan Period	Sets the time interval at which the IH Browser queries enabled Masters and/or Repeaters for their scan information. Valid interval is between 30 and 3600 seconds.
Enable Notifications	Description
Foreign APs	When checked a notification is made when a new Foreign AP is detected.
New Connected RLX2	When checked a notification is made when a new RLX2 is added to the Connected RLX2s section.
Communication Settings	Description
Pop Up	When checked a pop-up is used as means of a notification. Note: at present this is the only communication mechanism for notification events.

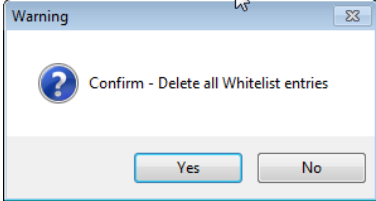
Whitelist Operations	Description
Delete	<p>Click to delete the current whitelist. A pop-up is shown to verify the deletion.</p> 
Import...	<p>Click to import a whitelist file. Note: This will overwrite any whitelist currently being maintained by the Foreign AP Detection feature. First perform an export to save the current whitelist if you wish to retain the current whitelist for future use.</p>
Export...	<p>Click to export the whitelist to a file. This file can then be imported by any IH Browser that wishes to use this whitelist.</p>
Save Settings	<p>Click this button to save any changes made to the settings in this dialog.</p>

5.12.5 Session Log

The Foreign AP Detection window maintains a session log with information on each event that occurs such as detecting a new Foreign AP as well as moving APs from/to the whitelist.

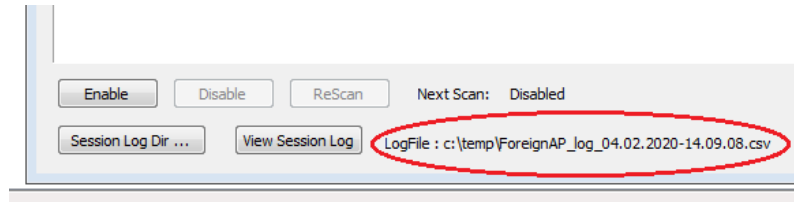

The directory the session log is written to is shown at the bottom of the Foreign AP Detection window. To change the directory the log is written to, click the **SESSION LOG DIR...** button. A Windows navigator dialog appears that allows directory selection.

Each time Foreign AP Detection Enabled, a new session file is started in the directory. The session file is a .csv (comma separated values) and can be opened by any spreadsheet program. The file name used includes the date and time the session file was started.

ForeignAP_log_04.02.2020-13.26.32 - Excel

Time	Msg ID	BSSID	Channel	SSID	Message	RSSI	Detected By	First Detected
2020/04/02-13:26:32	9	00:0D:8D:F0:5C:C8	149	line_3	Load Whitelist Entry from File			
2020/04/02-13:26:32	9	00:0D:8D:F0:E5:25	149	line_3	Load Whitelist Entry from File			
2020/04/02-13:26:32	9	00:0D:8D:F0:E7:70	149	line_3	Load Whitelist Entry from File			
2020/04/02-13:26:32	9	00:0D:8D:F0:E8:C9	149	line_3	Load Whitelist Entry from File			
2020/04/02-13:26:32	9	00:0D:8D:F0:D6:77	48	line_3	Load Whitelist Entry from File			
2020/04/02-13:26:32	9	24:05:88:38:6C:04	149	Manrkemesh	Load Whitelist Entry from File			
2020/04/02-13:26:32	9	24:05:88:38:4B:FD	149	Manrkemesh	Load Whitelist Entry from File			
2020/04/02-13:26:32	9	24:05:88:38:4C:CE	149	Manrkemesh	Load Whitelist Entry from File			
2020/04/02-13:26:32	9	24:05:88:38:6C:00	149	Manrkemesh	Load Whitelist Entry from File			
2020/04/02-13:26:32	9	6C:3B:6B:3F:DF:0F	48	MikroTik-3FDF0F	Load Whitelist Entry from File			
2020/04/02-13:26:38	2	24:05:88:38:6C:04	149	Manrkemesh	Detected New Foreign AP	0	Master1 (10.23.1.107)	13:26:38
2020/04/02-13:26:38	2	6C:3B:6B:3F:DF:0F	48	MikroTik-3FDF0F	Detected New Foreign AP	0	Master1 (10.23.1.107)	13:26:38
2020/04/02-13:26:38	2	7C:5A:1C:44:73:21	149	COE Open	Detected New Foreign AP	0	Master1 (10.23.1.107)	13:26:37
2020/04/02-13:26:38	2	7C:5A:1C:44:73:D5	149	COE Open	Detected New Foreign AP	0	Master1 (10.23.1.107)	13:26:30
2020/04/02-13:26:38	2	82:5A:1C:44:73:21	149	COESecure	Detected New Foreign AP	0	Master1 (10.23.1.107)	13:26:34
2020/04/02-13:26:38	2	82:5A:1C:44:73:D5	149	COESecure	Detected New Foreign AP	0	Master1 (10.23.1.107)	13:26:36
2020/04/02-13:26:38	2	86:5A:1C:44:73:21	48	COE_Enterprise	Detected New Foreign AP	0	Master1 (10.23.1.107)	13:26:38
2020/04/02-13:26:38	5	00:0D:8D:F0:5C:DB	48	line_1	Detected New RLX2 attached Unit	-58	Master2 (10.23.1.121)	13:26:38
2020/04/02-13:26:38	2	00:0D:8D:F0:5C:C8	149	line_3	Detected New Foreign AP	-19	Master3 (10.23.1.108)	13:26:38

5.12.6 Hiding the Foreign AP Detection window

When the Foreign AP Detection feature is active, the button at the bottom right of the window changed from **CLOSE** to **HIDE**. Note that the IH Browser cannot be closed if the feature is running. Clicking on the **HIDE** button closes the window but the feature remains active.

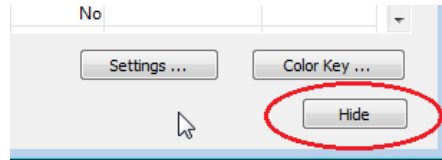

The current status of the Foreign AP Detection function can always be viewed from the IH Browser's Toolbar. When the feature is active, the Foreign AP Detection icon is green.

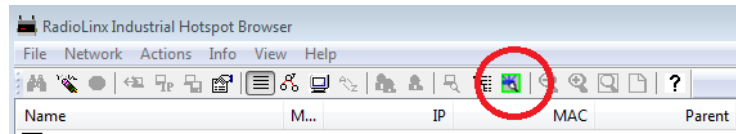

If a Foreign AP is detected while the window is closed, the icon turns red.

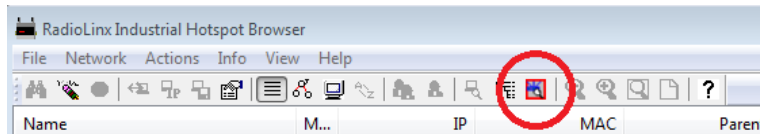

6 Diagnostics and Troubleshooting

Use the IH Browser's diagnostic and signal strength settings at the top of the *Radio Settings* window to make sure the network is working properly:

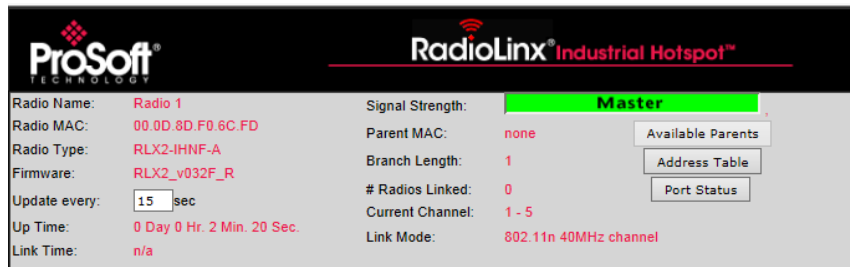

- **Signal Strength:** This shows the radio's signal strength.
 - *Master* appears if this is a Master radio.
 - *Scanning* appears if the radio is scanning to connect to another radio.
 - *Not Connected* appear if the radio is not connected to a network and not currently scanning.
- **Update every:** Specifies the interval (in seconds) between updates.
- The other parameters on this display are Read-only.

Tip: You can display the help topic for any parameter by clicking the parameter name.

You can perform the following troubleshooting routines:

- Check the Ethernet cable
- Check the LEDs on the radio
- Retrieve the default password by resetting the radio
- View error messages in the IH Browser
- Find missing radios

6.1 Checking the Ethernet Cable

If the radio's Ethernet port is connected to a PC or network, and the Ethernet LED does not light on the radio, there may be a problem with the Ethernet cable. Verify that the cable is plugged into the radio at one end, and to an Ethernet hub, a PC, or a 10/100/1000 Base-T Ethernet switch at the other end.

If using the PoE injector, verify that the M12 to RJ45 cable is connected between the radio and the injector and also that the Ethernet patch cable is connected between the injector and the switch.

Note: The RLX2-IHx series radio auto-detects the Ethernet connection type, and does not require a crossover cable for direct connection to a PC.

6.2 LED Display

The RLX2-IHx series radio front panel includes a set of LEDs that indicate the radio's status.

LED	Description
POWER	<ul style="list-style-type: none"> ● Booting up ● Fully operational <p>This two-color LED turns amber when power is first applied. After power is applied, this LED goes out completely for about four seconds while the internal hardware is initialized. After initialization the power LED turns green, indicating the radio is fully operational.</p>
RF TRANSMIT	<ul style="list-style-type: none"> ● Transmitting data over the wireless interface
RF RECEIVE	<ul style="list-style-type: none"> ● Receiving data over the wireless interface
SERIAL	<ul style="list-style-type: none"> ● Receiving serial data
ETHERNET	<ul style="list-style-type: none"> ● Transmitting Ethernet data over the wireless interface <p>Note that the state of the front-panel ETHERNET LED may not necessarily correspond to the state of the DATA LED on the Ethernet connector. The DATA LED on the Ethernet connector indicates traffic over the wired link, while the ETHERNET LED indicates network data sent or received through the wireless link.</p> <p>For example, if the radio is pinged over the wired link, the DATA LED on the Ethernet connector blinks but the ETHERNET LED does not (because the ping packet was not transmitted over the air).</p>
NET	<ul style="list-style-type: none"> ▶ Blinks if SD card with new configuration inserted. Reserved for future additional use.
MOD	<ul style="list-style-type: none"> ▶ Blinks if SD card with new configuration inserted. Reserved for future additional use.
SIGNAL STRENGTH	<ul style="list-style-type: none"> ▶▶▶ Blinks if SD card inserted with new configuration. This is for all radio modes. <p>Radios in Master mode:</p> <ul style="list-style-type: none"> ○ ● ○ No radios linked ○ ● ■ One or more radios linked (right LED blinking). ▶▶▶ DFS Channel Availability Check in progress (all LEDs blinking Amber) <p>Radios in Repeater or Client mode:</p> <ul style="list-style-type: none"> ○ ○ ○ No Signal ● ○ ○ Radio linked, Poor Signal ● ● ○ Radio linked, Fair Signal ● ● ● Radio linked, Good Signal

The following LEDs should illuminate when you connect the power and Ethernet cables to the radio.

- The POWER LED should turn green.
- The SPEED LED on the Ethernet connector should indicate a valid wired link. This LED is located at the top of the Ethernet RJ-45 connector and is marked SPEED
 - OFF = 10 MB
 - ON = 100 MB
 - BLINK = 1GB.
- The RF TRANSMIT and RF RECEIVE LEDs should start to blink occasionally.

For radios in Repeater or Client mode, all three SIGNAL STRENGTH LEDs blink just after the radio links to the Master radio but before fully authenticating the link. Normally this lasts only a few seconds. If the SIGNAL STRENGTH LEDs blink for longer than a few seconds, or do not stop blinking, it usually means the encryption keys are not correct. The Wireless Security Settings on a Repeater radio must match those on the Master radio. See *Configuring a Radio - Getting Started* (page 40).

6.3 Resetting a RLX2-IHx series Radio

If you lose the password to a radio, you cannot change the radio settings. You can reset the radio to restore the default password, but the radio loses all the configuration settings and returns to the default settings.

6.3.1 Resetting the RLX2-IHNF-W and RLX2-IHNF-WC to Defaults

These steps reset the radio to its default settings, including the default password.

- 1 Remove power from the radio.
- 2 Press the *Reset* button. The Reset button is located on the front of the unit just under the ProSoft logo.

The Reset button is located under this logo. Press firmly to reset the radio to its default settings.



- 3 While holding down the button, apply power to the radio and continue to hold the button down for 30 seconds.

This resets the radio to its default settings. You can now log in to the radio using the default password: **password**.

6.3.2 Resetting All Other Radios

These steps reset the radio to its default settings, including the default password.

- 1 Remove power from the radio.
- 2 Locate the **Reset** button hole.



- 3 Insert the end of a paperclip or similar device into the hole to press the reset button.
- 4 While pressing the reset button in with a paperclip, apply power to the radio, and continue to hold down the reset button for 30 seconds.

This resets the radio to its default settings. You can now log in to the radio using the default password: **password**.

6.4 Unable to scan for AP's error message

The *Unable to scan for AP's* error message may appear in the IH Browser when it attempts to scan for radios and no valid network connection exists on the PC (wired or wireless).

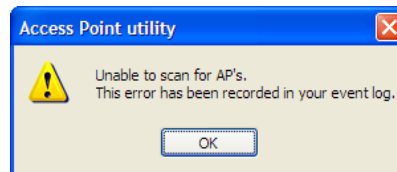

To correct this error

- 1 Confirm that the PC has at least one active network (LAN) connection. It could be a wired Ethernet connection or a wireless 802.11 connection.
- 2 Confirm that the network connection has a valid IP address. The network connection might need to have a static IP address assigned to it. Check the IP address of the network connection to determine that one has been assigned.

6.5 Finding Missing Radios

If the radios are not visible in the IH Browser, try the following:

- 1 Refresh the IH Browser display. See *Refreshing the Display in the IH Browser* (page 38). The IH Browser sends scans as broadcast messages, which can be dropped in RF connections, requiring that you repeat the scan.
- 2 Disable any software firewall running on the PC (This is most common in Windows XP and newer). Open the *Network connections* folder in the Windows Control Panel, then open the *Local Area Connection Properties* window and verify that the check box under **INTERNET CONNECTION FIREWALL** is not checked.
- 3 If these steps do not help, verify that the PC running the IH Browser and the radios are connected to the same local network.
- 4 In the IH Browser, change to the *Topology view*. From the **VIEW** menu, click **TOPOLOGY VIEW**. Any unlinked radios may appear at the bottom of the window. Scroll down to see all the unlinked radios. If you still cannot see the radios in the IH Browser, call ProSoft Technology Technical Support. See *Contacting Technical Support* (page 237).

7 Appendix A - Adding a Radio to RSLogix 5000

You can use an *Add-On Instruction* (AOI) to add an RLX2-IHx series radio to RSLogix 5000™. You can then extract information from the radio and transfer it to the ControlLogix processor connected by EtherNet/IP™. This allows you to view and use the radio status and diagnostic information in the program on the controller.

Note: You must download the RLX2-IHx series radio Add-On Instruction from the ProSoft Technology website. Go to www.prosoft-technology.com and search for your radio. From the RLX2-IHx series radio webpage, download the Add-On Instruction.

There are two procedures that you must complete in order to import and use the RLX2-IHx series Add-On Instruction in RSLogix 5000.

- 1 Add the RLX2-IHx series radio to a project in RSLogix 5000.
- 2 Import the AOI into the MainRoutine ladder logic in the same project.

7.1 Adding the Radio to RSLogix 5000

- 1 In RSLogix 5000, open an existing project, or create a new project
- 2 In the *Controller Organizer*, right-click **1756 BACKPLANE, 1756-A7** and then click **NEW MODULE**.

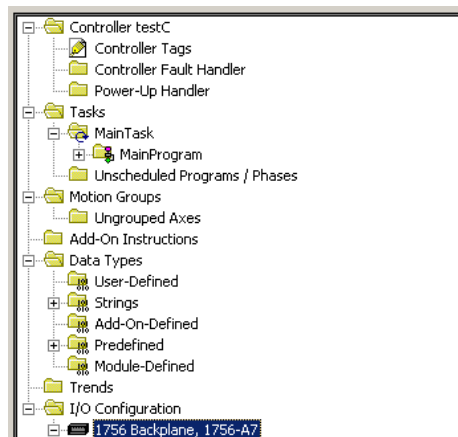

- 3 In the *Select Module Type* dialog box, select the correct Ethernet card (ENBT in this example) and click **OK**.



- 4 Enter a name for the card (*Ethernet* in this example) and the **IP ADDRESS** and then click **OK**.

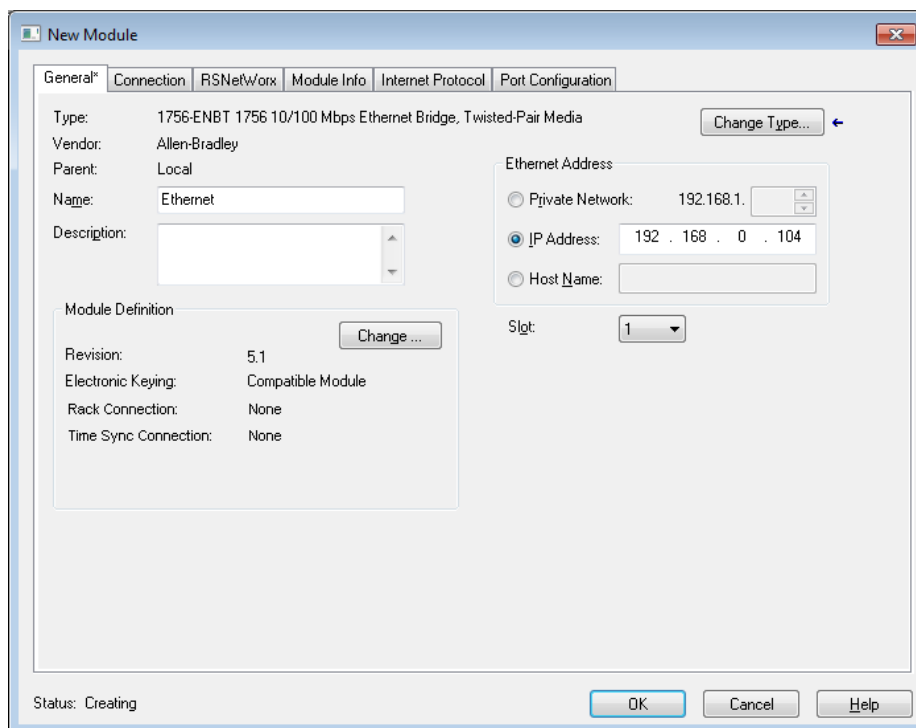

- In the Controller Organizer, right-click the new **ETHERNET** module and then click **NEW MODULE**.

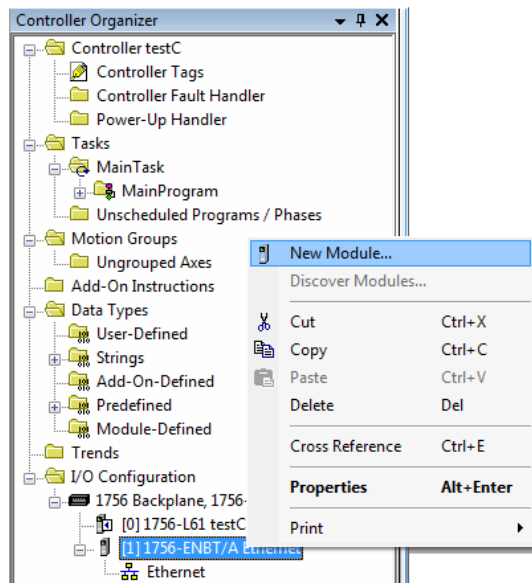

- In the *Select Module Type* dialog box, click **ETHERNET-BRIDGE GENERIC ETHERNET/IP CIP BRIDGE** and then click **OK**.

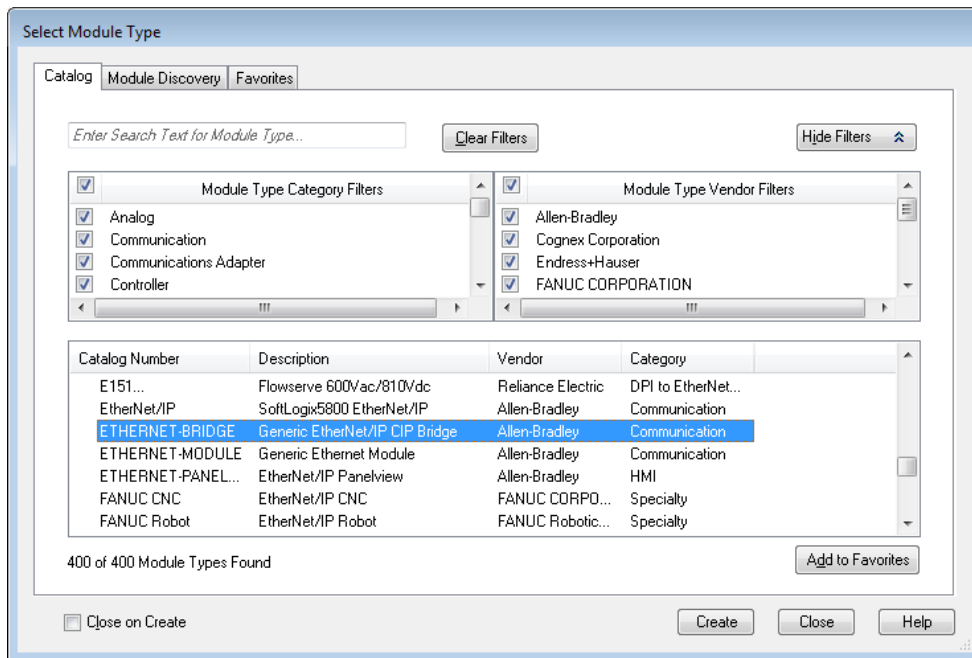

- In the *New Module* dialog, enter the **NAME** (RLX2 in this example).

- 8 Select the **IP ADDRESS** radio button and type in the IP address of the RLX2-IHx series radio, and then click **OK**.

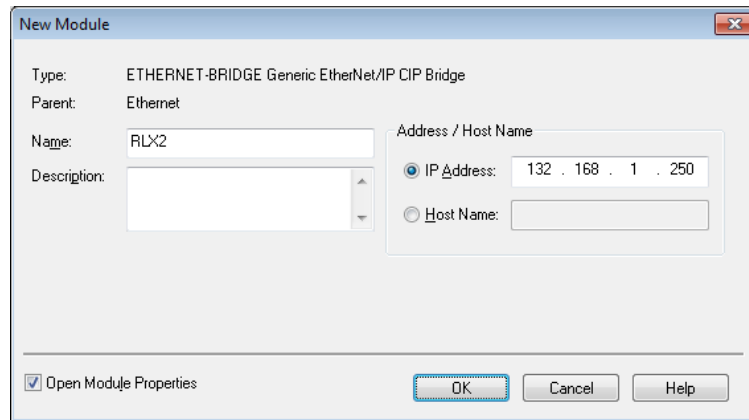

- 9 In the *Module Properties* dialog box, click **OK**. The Ethernet Bridge appears in the *Controller Organizer*.

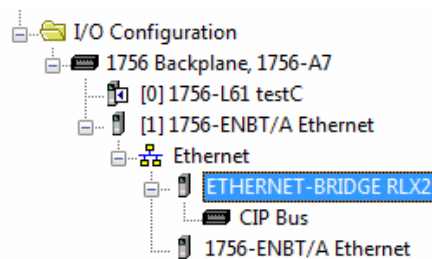

7.2 Importing the Add-On Instruction

- 1 In RSLogix 5000, in the *Controller Organizer* window, expand the **TASKS** folder until you see the **MAINPROGRAM** folder.
- 2 Under the **MAINPROGRAM** folder, double-click **MAINROUTINE** to open the MainRoutine in the *Ladder Editor*.
- 3 Right-click an empty rung in the routine, and then click **IMPORT RUNG...**

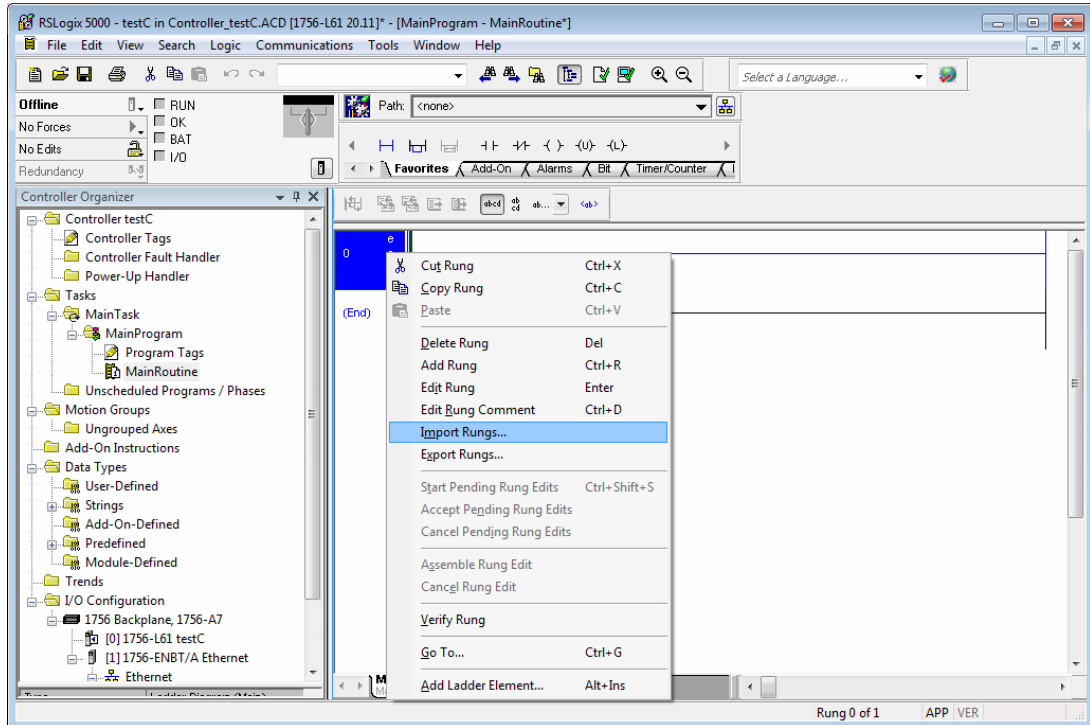

- 4 Navigate to the location on your PC where you saved the Add-On Instruction (for example, Desktop). Select the .L5X file and click **IMPORT**.

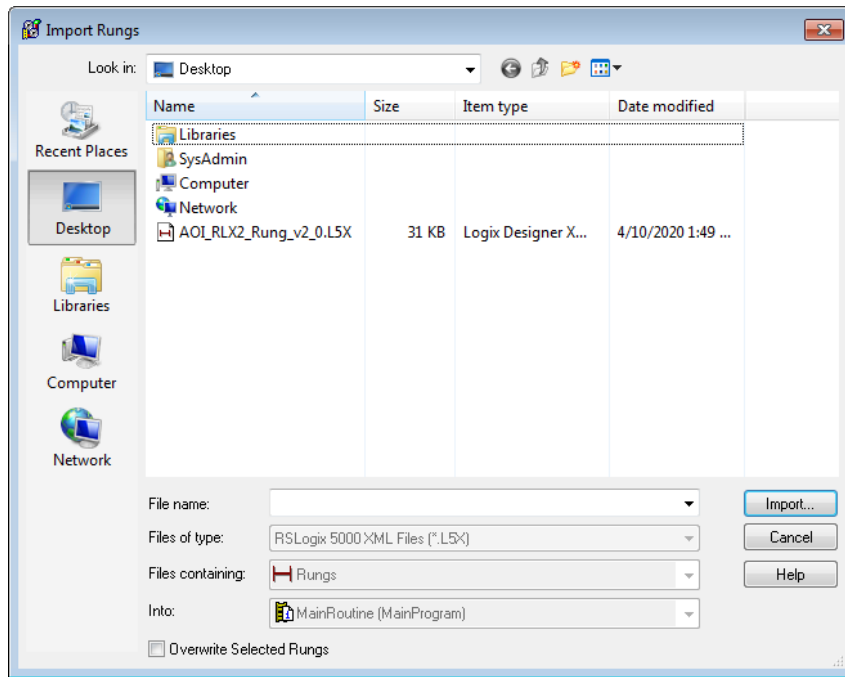

- 5 This opens the *Import Configuration* dialog box. Click **TAGS** to see the controller tags that the Add-On Instruction creates.

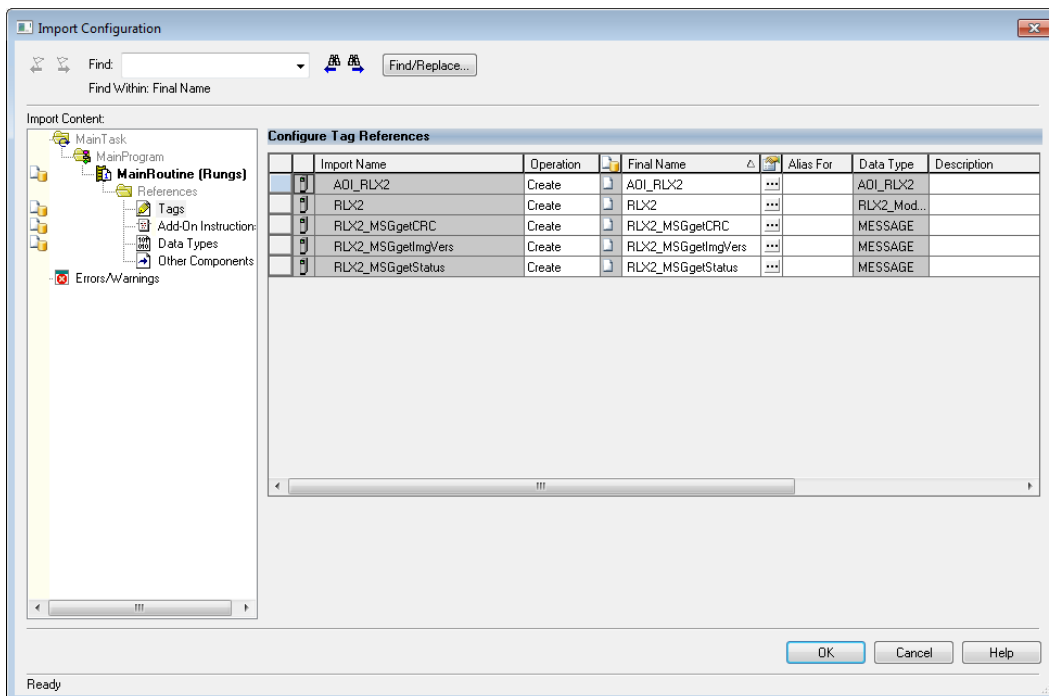

- Click **OK** to import the AOI. A progress bar appears during the import.

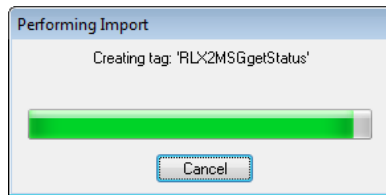

- After the import completes, the new rung with the Add-On Instruction appears in the Ladder editor.

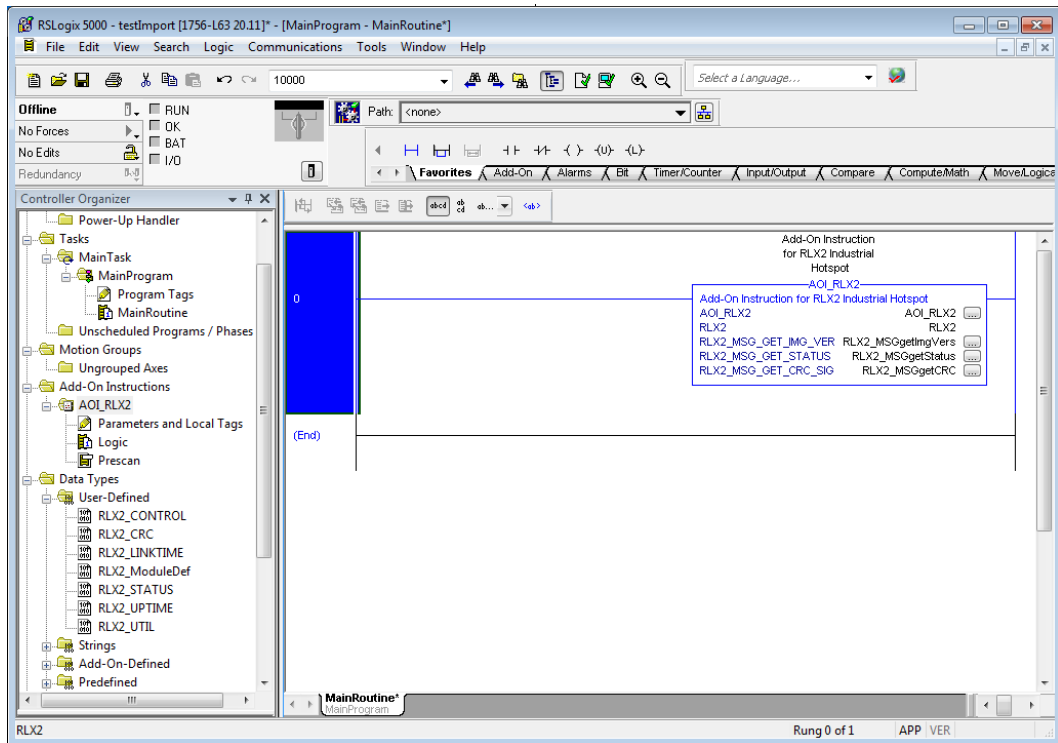

The procedure also imports new User Defined Data Types, Controller Tags, and the Add-On instruction for your project.

- 8 Ensure that a communications path exists using the *Who Active* dialog as shown.

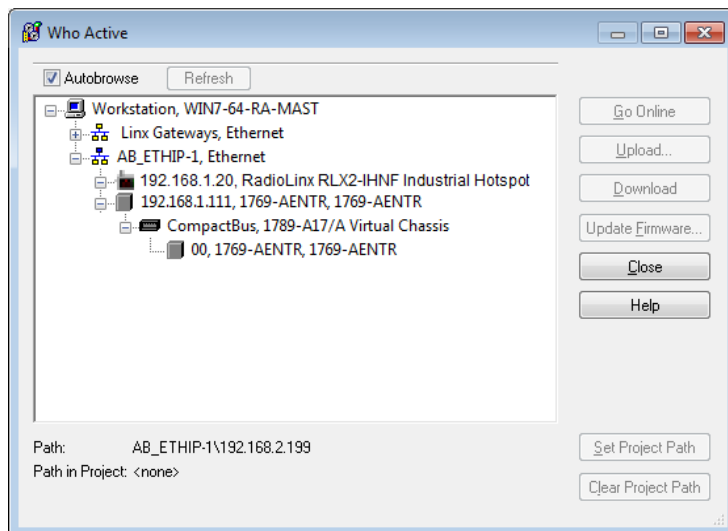

- 9 Save the project. When ready, download the project to the processor.

7.3 RLX2 Controller Tags

You use the controller tags in RSLogix 5000 to monitor elements of the RLX2-IHx series radio from RSLogix 5000. You use only the RLX2.xxx controller tag structure for this purpose.

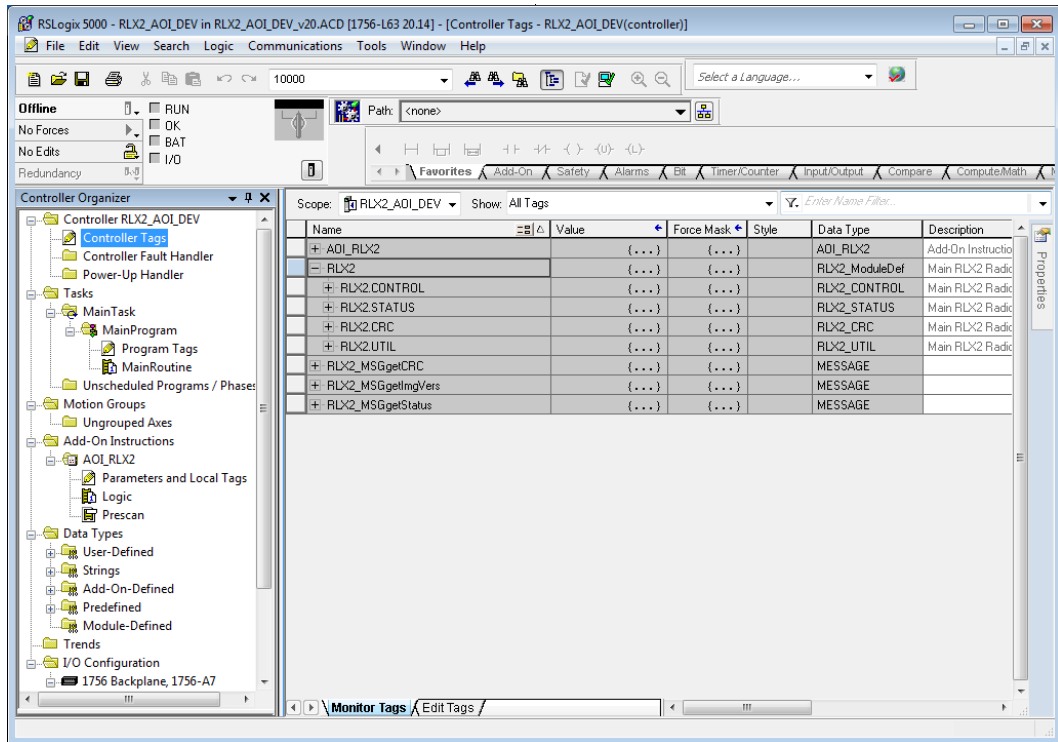

7.3.1 RLX2.CONTROL

This array contains trigger bits used to request functions from the RLX2-IHx series radio. The description is "Main RLX2 Radio definition Reads status of Diagnostic data from RLX2."

After execution, the bit is reset to 0 to be ready for the next execution.

7.3.2 RLX2.STATUS

This array is populated when the *RLX2.CONTROL.Get_Status_Data* is triggered. The following is the CIP™ object definition to read the RLX2-IHx Diagnostics and Status information.

CIP Data Tag Name	Data Type	Description
RLX2.STATUS.SSID	SINT[32]	Service Set Identifier is a name assigned to the wireless network
RLX2.STATUS.IPAddress	SINT[4]	IP address of RLX2-IHx radio
RLX2.STATUS.MACAddress	SINT[6]	Media Access Control (MAC) address of the device
RLX2.STATUS.NetworkMode	SINT	RLX2 radio network mode 6 = Master 7 = Repeater 1 = Client
RLX2.STATUS.ConnectionState	SINT	Connection State of RLX2 radio found at the bit-level (RLX2.STATUS.ConnectionState.x) Bit sequence [yyyy 0001] = 1 = Not connected Bit sequence [yyyy 0010] = 2 = Scanning Not reported = 3 = Locally connected Bit sequence [yyyy 0100] = 4 = Globally connected Where y = RLX2 radio model type: Bit sequence [0001 zzzz] = 802.11g (2.4 GHz) radio Bit sequence [0010 zzzz] = 802.11a (5 GHz) radio Bit sequence [0011 zzzz] = 802.11n radio Example: Bit sequence 0010 0100 = 36 = Globally connected 5 Ghz radio
RLX2.STATUS.SignalStrength	INT	Current Strength of the signal in dBm
RLX2.STATUS.Channel	SINT	Current Channel in which RLX2-IHx is transmitting
RLX2.STATUS.WEP	SINT	WEP encryption key
RLX2.STATUS.Flags	DINT	Flags value when bit is set: Flags [0/1] = Extension channel above/below Flags [2] = SSID is hidden Flags [3] = Do not allow children Flags [4/5] = STP/RSTP enabled Flags [6] = Transmit using GI40 Flags [7] = (Not used) Flags [8] = RLX2-IHx in Bridging Client Mode Flags [9] = DHCP is enabled Flags[10] = NAT is enabled
RLX2.STATUS.MasterMACAddress	SINT[6]	MAC Address of Parent Radio in which Repeater or Client is linked
RLX2.STATUS.HopCount	SINT	Number of hops to the master
RLX2.STATUS.PortStatus	SINT	Ethernet Port Status xxxx x1xx = RLX2-IHx Ethernet cable attached x, N/A
RLX2.STATUS.Associations	INT	Number of devices wirelessly connected to radio

RLX2.STATUS.BridgeAssociations	INT	Number of RLX2-IHx bridges to which radio has a wireless connection
RLX2.STATUS.TxRadioThroughput	INT	Transmit throughput in kilobytes per second
RLX2.STATUS.RxRadioThroughput	INT	Receive throughput in kilobytes per second
RLX2.STATUS.Uptime	DINT	This is the amount of time the radio has been running since power up in seconds
RLX2.STATUS.Linktime	DINT	The time the radio has been linked in seconds
RLX2.STATUS.TxPacketRate	DINT	Packets per second transmitted on air
RLX2.STATUS.RxPacketRate	DINT	Packets per seconds received on air
RLX2.STATUS.ModuleName	SINT[32]	The name of the radio
RLX2.STATUS.ProductName	SINT[32]	Name of product
RLX2.STATUS.ImageVerStr	SINT[28]	Firmware version loaded in device
RLX2.STATUS.TxGood	DINT	Number of Good Transmitted Frames
RLX2.STATUS.RxGood	DINT	Number of Good Received Frames
RLX2.STATUS.TxBad	DINT	Number of Bad Transmitted Frames
RLX2.STATUS.RxBad	DINT	Number of Bad Received Frames
RLX2.STATUS.TxDirectedFrames	DINT	Number of Transmitted Directed Frames
RLX2.STATUS.TxMulticastFrames	DINT	Number of Transmitted Multicast Frames
RLX2.STATUS.TxBroadcastFrames	DINT	Number of Transmitted Broadcast Frames
RLX2.STATUS.RxDirectedFrames	DINT	Number of Received Directed Frames
RLX2.STATUS.RxMulticastFrames	DINT	Number of Received Multicast Frames
RLX2.STATUS.RxBroadcastFrames	DINT	Number of Received Broadcast Frames
RLX2.STATUS.RxCRCErr	DINT	Number of CRC Errors

The following additional array elements are populated if the RLX2 is running firmware greater or equal to *RLX2_v0038_R*.

RLX2.STATUS.Retries	SINT	The radio retransmission percentage (0-100%) Retries = # retransmissions / total transmissions
RLX2.STATUS.Utilization	SINT	The percentage of time the media is detected as busy. (0-100%)
RLX2.STATUS.ChannelWidth	SINT	Configured channel width (20 or 40 MHz)
RLX2.STATUS.Antennas	SINT	Antenna Status xxxx xxyy, where yy = # of Enabled Antennas x, N/A
RLX2.STATUS.TxRate	INT	Encoded current Tx Rate to Parent (Client/Repeater mode only) 0x800y, where y => MCSy, or 0x0zzz, where zzz = bit rate in 100 kb/s units
RLX2.STATUS.TxBitRate	INT	Decoded actual signaling bit rate on the air in 100 kb/s units
RLX2.STATUS.TxBcastRate	INT	Broadcast (ff:ff:ff:ff:ff:ff) packet rate being sent to radio. Value calculated every 5 seconds.
RLX2.STATUS.TxMcastRate	INT	Multicast (01:xx:xx:xx:xx:xx) packet rate being sent to radio. Value calculated every 5 seconds.
RLX2.STATUS.ReservedXX	DINT	16 DINT variables reserved for future use.

8 Appendix B - Radio Hardware

8.1 Radio Power Requirements (RLX2-IHNF-W)

These cables are available for purchase from ProSoft Technology:

Description	ProSoft Part Number
Power Cable, 3m (7 ft), M12 to un-terminated leads	CULPWR-M12-010
Power Cable, 10m (33 ft), M12 to un-terminated leads	CULPWR-M12-033



The RLX2-IHNF-W and WC radios accept PoE configuration.

- The RLX2-IHNF-W radio is equipped with a power M12 port (IEC 61076-2-101).
- The RLX2-IHNF-WC Ethernet and PoE cable protrudes from the module. There is no M12 port.

Contact Assignment of the M12 Socket

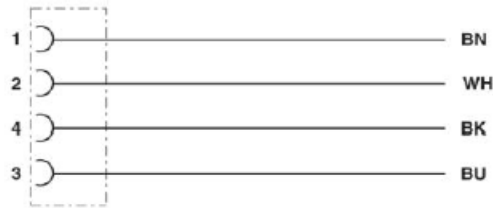

- BK (Black) and BU (Blue) wires are tied together and connect to "+".
- BN (Brown) and WH (White) wires are tied together and connected to "-".

Pin Assignment M12 Socket, 4-pos, A-coded, View Female Side

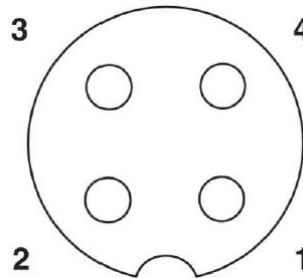

8.2 Radio Power Requirements (All other radios)

Note: The following instructions do not pertain to the RLX2-IHNF-W radio.

The RLX2-IHx series radios accept voltages between 10 and 24 VDC, with an average power draw of less than 8 Watts. A detachable power connector comes with the radio, as shown below. The connector terminals are labeled + (positive DC connection) and - (DC ground connection).

You can use the AC-to-DC power supply adapter supplied with the optional RLX-IHBTB Bench Test Kit to convert the input power. The DC power wires must be less than 3 meters in length to meet regulatory requirements.

Warning: When wiring the power connector supplied with the radio, be sure to observe the proper polarity markings on the power connector. **Wiring the connector incorrectly can cause serious damage to the radio which is not covered under the ProSoft Technology warranty.**

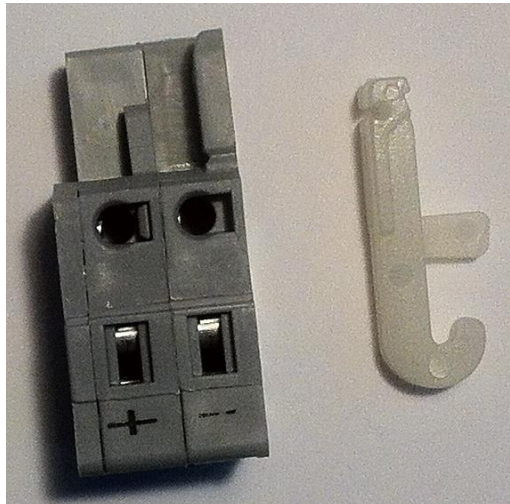

The power connector (ProSoft Technology part number 002-0116) is shown on the left in the photo above. Note the + and – polarity markings. The wire installation tool (ProSoft part number 357-0061) shown on the right is helpful for installing wires into the spring-loaded contacts inside power connector.

To use the installation tool, insert it into the connector as shown below.

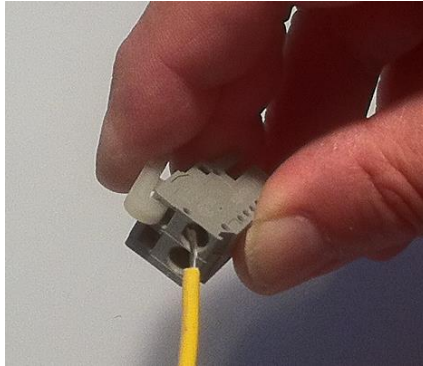

Press down on the installation tool to use it as a level to open the connector's contacts to insert a wire. A properly-wired power connector is shown below.



The RLX2-IHx series radios accept power from 802.3af Mode B or passive Power over Ethernet (PoE) sources supplying 48VDC, with an average power draw of less than 8 watts. ProSoft Technology offers the following passive PoE injectors for use with the RLX2-IHx series radios:

POE-48I-AC	Power over Ethernet Injector, AC input
POE-48I-DC-DC	Power over Ethernet Injector, 9 to 36 VDC input voltage

- The radio shall be installed by trained personnel only, as outlined in the installation instructions provided with each radio.
- The equipment shall be installed by a qualified installer/electrician. The installer/electrician is responsible for obtaining a secured ground connection between the lug terminal on the surge protector to a verified common ground point using a minimum 6 AWG gauge wire. This must be done when attaching power lines to the radio during installation.

Danger: A solid ground connection should be verified using a meter prior to applying power to the radio. Failing to secure a proper ground could result in serious injury or death as a result of a lightning strike.

Using Power over Ethernet (PoE) to power remote devices has several advantages:

- "Carrier Class" Power Over Ethernet system.
- Power can be supplied over long distances, up to 300 feet.
- Power can be available wherever network access is available.
- The power supply can be centrally located where it can be attached to an uninterruptible power supply.
- You can easily power or reset the attached equipment from a remote location.
- There is no need to run additional power cabling to the device as power can be supplied over the CAT5, CAT5E, or CAT6 Ethernet cable.
- You can save on the cost of coax cable and reduce RF losses for remote mounted radios.
- Built-in Ethernet surge protection to prevent equipment damage.
- Overload and short circuit protection.

8.3 Ethernet Cable Specifications

- The recommended cable is Category 5 or better. A Category 5 cable has four twisted pairs of wires, which are color-coded and cannot be swapped. The module uses only two of the four pairs when running at 10 MBit or 100 MBit speeds. All eight wires are used when running at 1000 MBit speeds.
- Category 5e or better cable is recommended for 1000 MBit speeds.
- The Ethernet port on the module is Auto-Sensing. Use either a standard Ethernet straight-through cable or a crossover cable when connecting the module to an Ethernet hub, a 10/100/1000 Base-T Ethernet switch, or directly to a PC. The module detects the cable type and uses the appropriate pins to send and receive Ethernet signals.
- Ethernet cabling is similar to U.S. telephone cables, except that it has eight conductors. Some hubs have one input that can accept either a straight-through or crossover cable, depending on a switch position. In this case, ensure the switch position and cable type agree.
- Refer to Ethernet Cable Configuration (page 199) for a diagram of how to configure Ethernet cables.

8.4 Ethernet Cable Configuration

8.4.1 Ethernet Cable Configuration (RLX2-IHNF-W)

The RLX2-IHNF-W weatherproof radio uses cables with M12 connectors on one end and RJ45 connectors on the other. These are Power over Ethernet (PoE) cables that you can purchase directly from ProSoft Technology.

Description	ProSoft Part Number
Network Cable, 2m (7 ft) M12 to RJ45	CURJ45-M12-007
Network Cable, 10m (33 ft) M12 to RJ45	CURJ45-M12-033



This PoE cable contains an M12 (IP65, IP67) connector on one end that attaches to the radio. The other end contains an RJ45 connector for a network connection or power injector.

Pin Assignments

M12 socket, 8-pos, A-coded, female	
RJ45 pin assignment	

Circuit Diagram

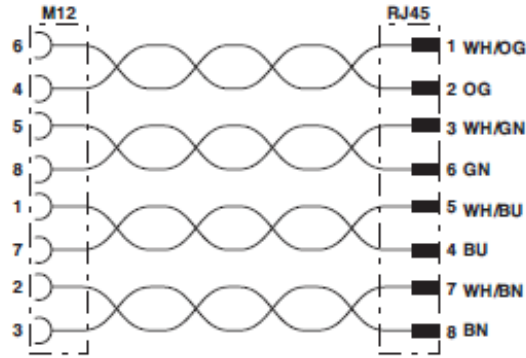

Contact assignment of the M12 and RJ45 plug

8.4.2 Ethernet Cable Configuration (all other radios)

The RLX2-IHx series radios (except the RLX2-IHNF-W weatherproof radio) use Ethernet cable. A diagram of the pin assignments appears below.

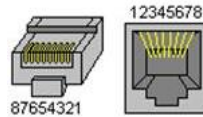

Straight-Though Cable

RJ-45 Pin	RJ-45 Pin
1 Rx+	1 Tx+
2 Rx-	2 Tx-
3 Tx+	3 Rx+
6 Tx-	6 Rx-

Crossover Cable

RJ-45 Pin	RJ-45 Pin
1 Rx+	3 Tx+
2 Rx-	6 Tx-
3 Tx+	1 Rx+
6 Tx-	2 Rx-

9 Appendix C - RLX2-IHx 5 GHz Radio DFS Support

Some channels in the 5 GHz band are shared with radar and must adhere to *Dynamic Frequency Selection* (DFS) rules. If the radio detects the presence of radar on its operating frequency, it must automatically change to another frequency.

Note: This applies only to radios that can operate at frequencies in the 5 GHz band.

9.1 DFS Radio Operations

If radar is detected on an operating channel, transmissions must cease within the required *Channel Closing Transmission Time*, and must move to a new channel within the required *Channel Move Time*. Before transmitting on a new DFS channel that has not been previously checked for radar, the RLX2-IHx series radio must monitor the channel for the *Channel Availability Check Time* before transmitting. Operations cannot return to a channel where radar was detected for at least the *Non-Occupancy Period*. The values for these parameters are noted in the table below:

Parameter	FCC Value	ETSI Value	ETSI Value 5.600 to 5.650 GHz (Channels 120, 124, & 128)
Channel Availability Check Time	60 seconds	60 seconds	10 minutes
Channel Move Time	10 seconds (12 seconds for "long pulse" radar)	10 seconds	10 seconds
Channel Closing Transmission Time	200 milliseconds (plus up to 60 milliseconds over 10 seconds)	1 second	1 second
Non-Occupancy Period	30 minutes	30 minutes	30 minutes

If a Master radio detects radar, it issues a channel change announcement to all Client and Repeater radios in the network. It then moves to a new channel within the *Channel Move Time*. (Typically, this move time is 500 milliseconds or less.) If the selected channel was not previously checked for the presence of radar, the Master radio must do so for the *Channel Availability Check Time* before it can begin to transmit. If the newly-selected channel is not a DFS channel, or if the channel was previously monitored for radar since the radio was powered on, transmissions can begin immediately.

During the *Channel Availability Check Time*, a radio blinks all three amber Signal Strength LEDs approximately once per second. If radar is detected on the new channel during the *Channel Availability Check Time*, the Master radio selects another channel and begins the process again.

If a Client or Repeater radio detects radar, in addition to stopping data transmission, must notify its parent of the presence of radar. Each unit receiving a radar notification from a child unit treats it the same as if it had detected radar itself and acts accordingly. Thus radar notifications always reach the Master radio which causes a channel change order to be issued.

After a Master radio successfully selects a DFS channel, Repeater or Client radios connect to the Master and scan for radar for an additional 60 seconds (*Channel Availability Check Time*). If a chain of Repeater radios ultimately connects to a Master radio using a DFS channel, the time to connect is 60 seconds for **each** Repeater radio in the chain as DFS channels are initially scanned for radar transmissions.

9.1.1 Selecting a DFS 5 GHz Channel

For Master radios operating in the 5 GHz band, you can select a DFS channel, or let the radio automatically select the DFS channel. DFS channels are a 5 GHz radio parameter only, and apply to all RLX2-IHx series radios except the RLX2-IHG.

Note: In some cases, the radio may select a channel in the 5 GHz Upper Band if it does not find an open channel in the 5 GHz DFS Band.

To Select a DFS Channel

On the **BASIC SETTINGS** tab, in the **BASIC WIRELESS SETTINGS** group, select the starting DFS channel. If the radio detects a radar signal on this channel, it changes the channel as described in DFS Radio Operations (page 201).

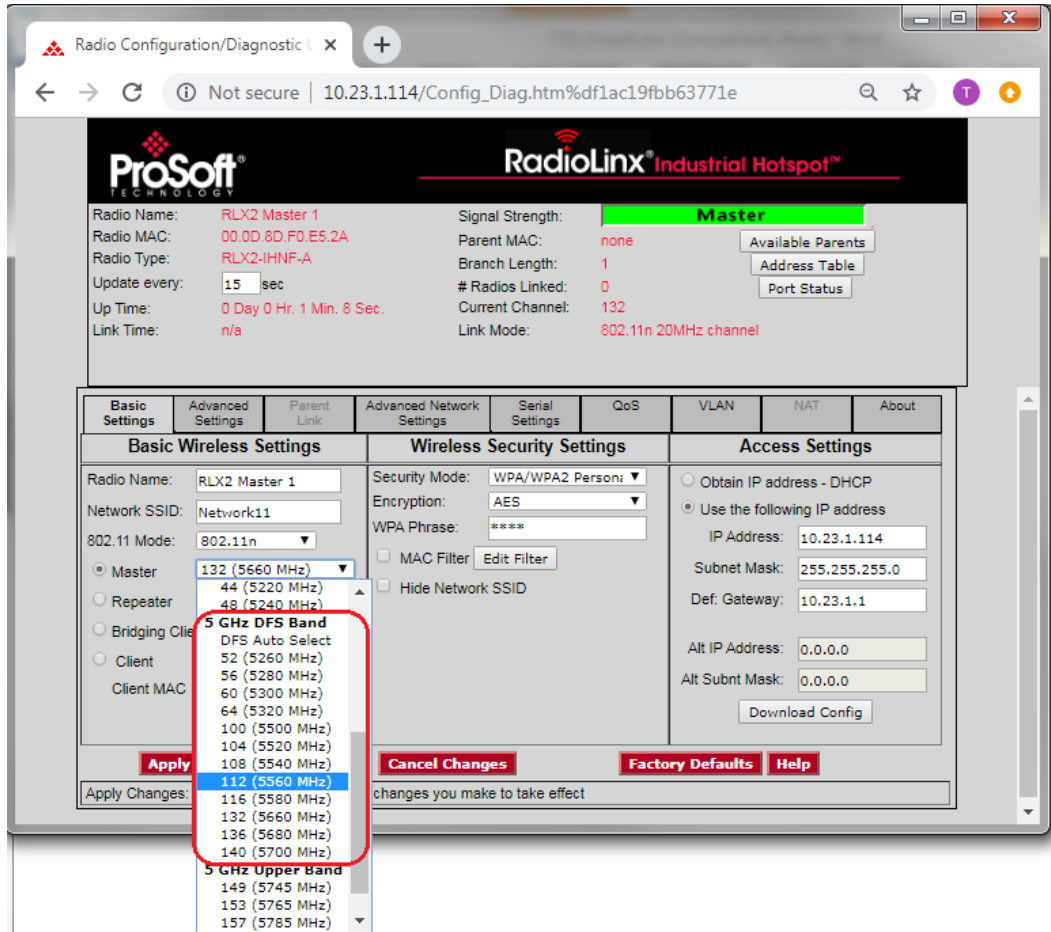

The actual channel in operation is always shown in the **CURRENT CHANNEL** display.

Current Channel: 132

To Use DFS Auto Select

On the **BASIC SETTINGS** tab, in the **BASIC WIRELESS SETTINGS** group, select the Master radio channel *DFS Auto Select*.

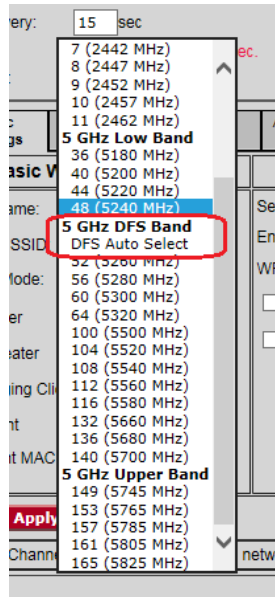

With this selection the radio randomly selects a DFS channel for operation. The actual channel in operation is always shown in the **CURRENT CHANNEL** display.

10 Appendix D - RLX2-IHx series Virtual LAN (VLAN) Functionality

Virtual Local Area Networks (VLANs) are typically used to segment core network components and network access rules. A VLAN provides the equivalent of a wired patch panel through software (packet filtering) rather than hardware (physical wires).

Constraining data to a particular Virtual LAN requires that the radio tag packets with a VLAN identifier. VLAN tagging simply adds extra information in the packet header of Ethernet frames so VLAN-enabled switches know how to pass along the data.

The RLX2-IHx series radios (version 33 and later) provide:

- Transparent support of VLAN tags (802.1Q)
- Port/Radio-based VLAN tagging with Managed Switches
- Port/Radio-based VLAN tagging without Managed Switches

10.1 Transparent Support of VLAN Tags (802.1Q)

The following provides an example of transparent communication between Managed Switches using VLAN trunking.

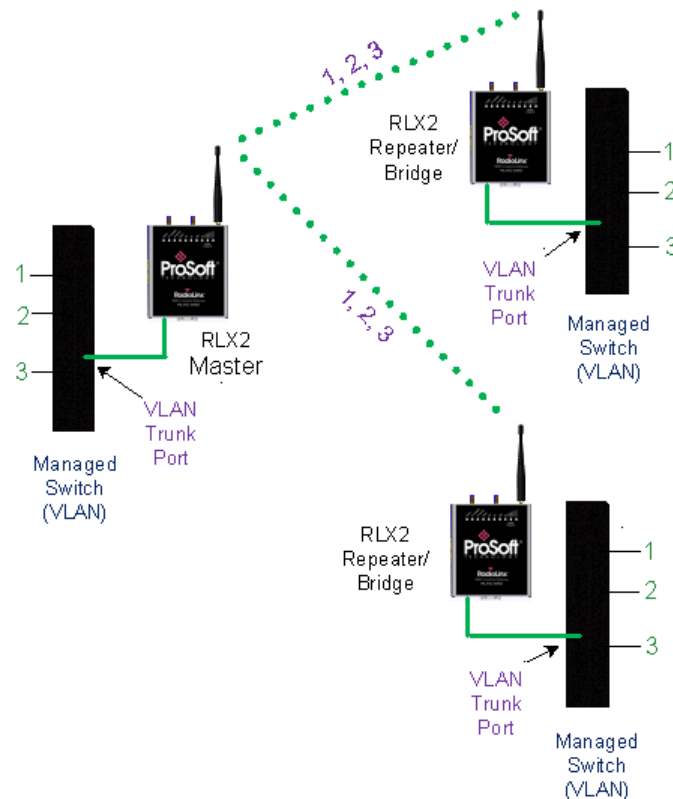

10.2 Port/Radio-based VLAN Tagging with Managed Switches

In this example, the network has three VLANs (capacity for 15). Each VLAN has access to a Managed Switch pre-configured to assign each VLAN to a specific port. The Radio supporting the Managed Switch passes on the 802.1Q frames. This example shows support for Radio to Radio VLANs using one or more Trunk Links.

- PLC, Drive, and HMI communicate on VLAN 1 and with the Control Network (same subnet).
- Mobile worker communicates to the SCADA network only (VLAN 2). The laptop communicates to Internet/Business Network only (VLAN 3).

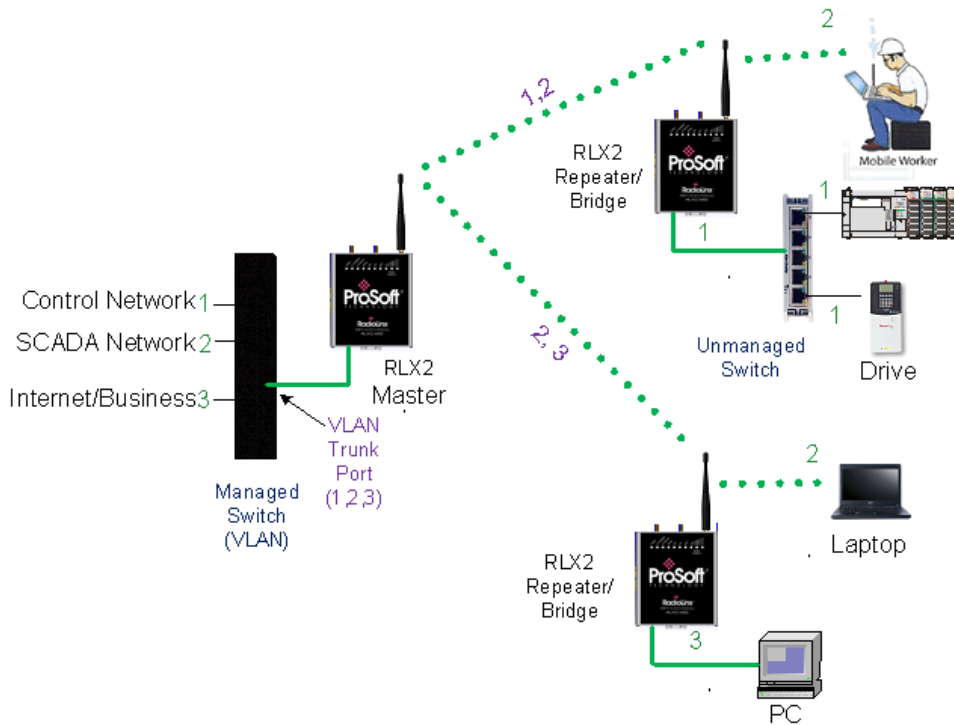

10.3 Port/Radio-based VLAN Tagging without Managed Switches

In the following example, the network has three VLANs (capacity for 15). Each VLAN has access to a specific Radio port. The Radio supporting the Managed Switch passes on the 802.1Q frames. The wireless network also supports Radio to Radio VLANs using one or more Trunk Links.

- PLC, Drive & HMI communicate on one VLAN on the same subnet.
- Mobile Worker/Laptop communicate with a fixed server on VLAN 2 (separate subnet).

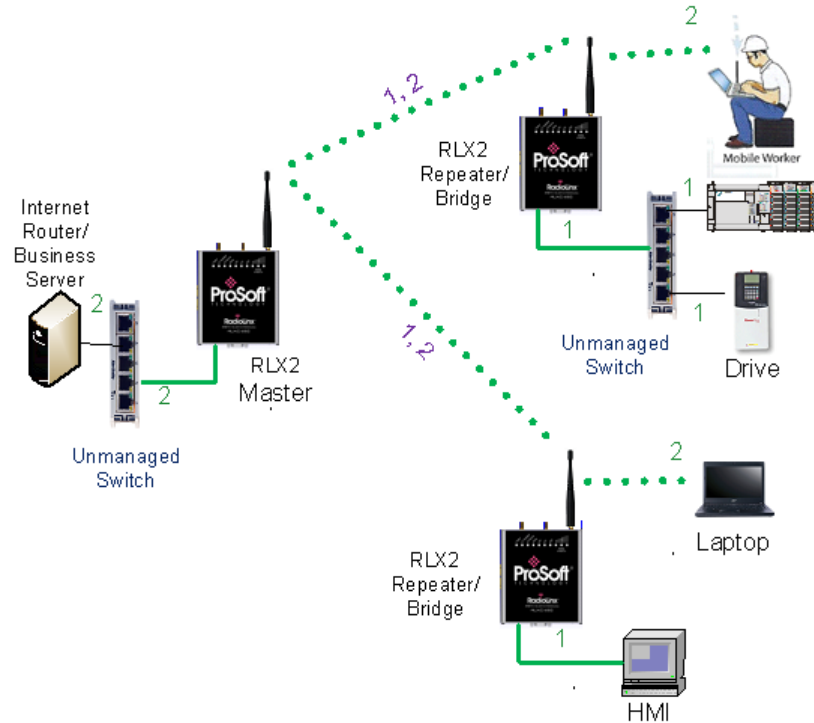

11 Appendix E - EtherNet/IP and Modbus TCP/IP Support

You can get diagnostic and status information from the RLX2-IHx series radio by querying the radio using either the Ethernet/IP or Modbus TCP/IP protocols.

11.1 Modbus TCP/IP Server Support

You can use a Modbus TCP/IP client to poll the RLX2-IHx series radio for diagnostic and status information. The Modbus TCP/IP server in the radio monitors port 502 and port 2000, and responds to requests from the port eth0 (Ethernet port) or ppp0 (Point-to-Point Protocol). PPP is a data link layer protocol that establishes a connection between two nodes.

The radio supports up to five concurrent Modbus TCP/IP client connection.

11.1.1 Modbus Memory Map Diagnostic Information

The topic lists the is the Modbus register addresses that you use to read the RLX2-IHx series radio diagnostic and status information.

Name	Data Type	Access	Modbus Register
RLX2_Diag.SSID	SINT[32]	Read	30001 to 30016
RLX2_Diag.IPAddress	SINT[4]	Read	30017 to 30018
RLX2_Diag.MACAddress	SINT[6]	Read	30019 to 30021
RLX2_Diag.NetworkMode	SINT	Read	30022
RLX2_Diag.ConnectionState	SINT	Read	30023
RLX2_Diag.SignalStrength	INT	Read	30024
RLX2_Diag.Channel	SINT	Read	30025
RLX2_Diag.WEP	SINT	Read	30026
RLX2_Diag.Flags	DINT	Read	30027 to 30028
RLX2_Diag.MasterMACAddress	SINT[6]	Read	30029 to 30031
RLX2_Diag.HopCount	SINT	Read	30032
RLX2_DiagStatus	SINT	Read	30033
RLX2_Diag.NumAssociations	INT	Read	30034
RLX2_Diag.NumBridgeAssocs	INT	Read	30035
RLX2_Diag.TxRadioThroughput	INT	Read	30036
RLX2_Diag.RxRadioThroughput	INT	Read	30037
RLX2_Diag.Uptime	DINT	Read	30038 to 30039
RLX2_Diag.LinkTime	DINT	Read	30040 to 30041
RLX2_Diag.TxPktThput	DINT	Read	30042 to 30043

RLX2_Diag.RxPktThput	DINT	Read	30044 to 30045
RLX2_Diag.ModuleName	SINT[32]	Read	30046 to 30061
RLX2_Diag.ProductName	SINT[32]	Read	30062 to 30077
RLX2_Diag.ImageVerStr	SINT[28]	Read	30078 to 30091
RLX2_Diag.tx_good	DINT	Read	30092 to 30093
RLX2_Diag.rx_good	DINT	Read	30094 to 30095
RLX2_Diag.tx_bad	DINT	Read	30096 to 30097
RLX2_Diag.rx_bad	DINT	Read	30098 to 30099
RLX2_Diag.tx_directed_frames	DINT	Read	30100 to 30101
RLX2_Diag.tx_multicast_frames	DINT	Read	30102 to 30103
RLX2_Diag.tx_broadcast_frames	DINT	Read	30104 to 30105
RLX2_Diag.rx_directed_frames	DINT	Read	30106 to 30107
RLX2_Diag.rx_multicast_frames	DINT	Read	30108 to 30109
RLX2_Diag.rx_broadcast_frames	DINT	Read	30110 to 30111
RLX2_Diag.rx_crc_error	DINT	Read	30112 to 30113

The following registers are available if the firmware in the RLX2 is *RLX2_v0038_R or greater*.

RLX2_Diag.Retries	INT	Read	30114
RLX2_Diag.Utilization	INT	Read	30115
RLX2_Diag.ChannelWidth	INT	Read	30116
RLX2_Diag.NumAntennas	INT	Read	30117
RLX2_Diag.TxRate	INT	Read	30118
RLX2_Diag.TxBitRate	INT	Read	30119
RLX2_Diag.TxBcstRate	INT	Read	30120
RLX2_Diag.TxMcstRate	INT	Read	30121
RLX2_Diag.OS_Files	DINT	Read	30122 to 30123
RLX2_Diag.Wireless_Files	DINT	Read	30124 to 30125
RLX2_Diag.Config_Files	DINT	Read	30126 to 30127
RLX2_Diag.Security_Files	DINT	Read	30128 to 30129
RLX2_Diag.Web_Files	DINT	Read	30130 to 30131
RLX2_Diag.SD_Card_Files	DINT	Read	30132 to 30133

*Modbus Function Code 4 (Read Input Registers(3X)) is supported.

11.2 EtherNet/IP™ Server Support

The CIP™ object definition that you use to read the RLX2-IHx series radio diagnostic and status information.

Class ID: 0xA1 (161) - RLX2 Info

Number of Instances: 1

CIP Data Tag Name	Data Type	Access
RLX2_Diag.SSID	SINT[32]	Read
RLX2_Diag.IPAddress	SINT[4]	Read
RLX2_Diag.MACAddress	SINT[6]	Read
RLX2_Diag.NetworkMode	SINT	Read
RLX2_Diag.ConnectionState	SINT	Read
RLX2_Diag.SignalStrength	INT	Read
RLX2_Diag.Channel	SINT	Read
RLX2_Diag.WEP	SINT	Read
RLX2_Diag.Flags	DINT	Read
RLX2_Diag.MasterMACAddress	SINT[6]	Read
RLX2_Diag.HopCount	SINT	Read
RLX2_Diag.Status	SINT	Read
RLX2_Diag.NumAssociations	INT	Read
RLX2_Diag.NumBridgeAssocs	INT	Read
RLX2_Diag.TxRadioThroughput	INT	Read
RLX2_Diag.TxRadioThroughput	INT	Read
RLX2_Diag.Uptime	DINT	Read
RLX2_Diag.Linktime	DINT	Read
RLX2_Diag.TxPktThput	DINT	Read
RLX2_Diag.RxPktThput	DINT	Read
RLX2_Diag.ModuleName	SINT[32]	Read
RLX2_Diag.ProductName	SINT[32]	Read
RLX2_Diag.ImageVerStr	SINT[28]	Read
RLX2_Diag.tx_good	DINT	Read
RLX2_Diag.rx_good	DINT	Read
RLX2_Diag.tx_bad	DINT	Read
RLX2_Diag.rx_bad	DINT	Read
RLX2_Diag.tx_directed_frames	DINT	Read
RLX2_Diag.tx_multicast_frames	DINT	Read
RLX2_Diag.tx_broadcast_frames	DINT	Read
RLX2_Diag.rx_directed_frames	DINT	Read
RLX2_Diag.rx_multicast_frames	DINT	Read
RLX2_Diag.rx_broadcast_frames	DINT	Read
RLX2_Diag.rx_crc_err	DINT	Read

Class ID: 0xA2 (162) - RLX2 Info Extended

Number of Instances: 1

Available from RLX2 radios with firmware *RLX2_v0038_R* or later.

CIP Data Tag Name	Data Type	Access
RLX2_Diag.SSID	SINT[32]	Read
RLX2_Diag.IPAddress	SINT[4]	Read
RLX2_Diag.MACAddress	SINT[6]	Read
RLX2_Diag.NetworkMode	SINT	Read
RLX2_Diag.ConnectionState	SINT	Read
RLX2_Diag.SignalStrength	INT	Read
RLX2_Diag.Channel	SINT	Read
RLX2_Diag.WEP	SINT	Read
RLX2_Diag.Flags	DINT	Read
RLX2_Diag.MasterMACAddress	SINT[6]	Read
RLX2_Diag.HopCount	SINT	Read
RLX2_Diag.Status	SINT	Read
RLX2_Diag.NumAssociations	INT	Read
RLX2_Diag.NumBridgeAssocs	INT	Read
RLX2_Diag.TxRadioThroughput	INT	Read
RLX2_Diag.TxRadioThroughput	INT	Read
RLX2_Diag.Uptime	DINT	Read
RLX2_Diag.Linktime	DINT	Read
RLX2_Diag.TxPktThput	DINT	Read
RLX2_Diag.RxPktThput	DINT	Read
RLX2_Diag.ModuleName	SINT[32]	Read
RLX2_Diag.ProductName	SINT[32]	Read
RLX2_Diag.ImageVerStr	SINT[28]	Read
RLX2_Diag.tx_good	DINT	Read
RLX2_Diag.rx_good	DINT	Read
RLX2_Diag.tx_bad	DINT	Read
RLX2_Diag.rx_bad	DINT	Read
RLX2_Diag.tx_directed_frames	DINT	Read
RLX2_Diag.tx_multicast_frames	DINT	Read
RLX2_Diag.tx_broadcast_frames	DINT	Read
RLX2_Diag.rx_directed_frames	DINT	Read
RLX2_Diag.rx_multicast_frames	DINT	Read
RLX2_Diag.rx_broadcast_frames	DINT	Read
RLX2_Diag.rx_crc_err	DINT	Read
RLX2_Diag.Retries	SINT	Read
RLX2_Diag.Utilization	SINT	Read
RLX2_Diag.ChannelWidth	SINT	Read
RLX2_Diag.NumAntennas	SINT	Read

RLX2_Diag.TxRate	INT	Read
RLX2_Diag.TxBitRate	INT	Read
RLX2_Diag.TxBcastRate	INT	Read
RLX2_Diag.TxMcstRate	INT	Read
RLX2_Diag.Reserved1	DINT	Read
RLX2_Diag.Reserved2	DINT	Read
RLX2_Diag.Reserved3	DINT	Read
RLX2_Diag.Reserved4	DINT	Read
RLX2_Diag.Reserved5	DINT	Read
RLX2_Diag.Reserved6	DINT	Read
RLX2_Diag.Reserved7	DINT	Read
RLX2_Diag.Reserved8	DINT	Read
RLX2_Diag.Reserved9	DINT	Read
RLX2_Diag.Reserved10	DINT	Read
RLX2_Diag.Reserved11	DINT	Read
RLX2_Diag.Reserved12	DINT	Read
RLX2_Diag.Reserved13	DINT	Read
RLX2_Diag.Reserved14	DINT	Read
RLX2_Diag.Reserved15	DINT	Read
RLX2_Diag.Reserved16	DINT	Read

Class ID: 0xA3 (163) - File CRC Signatures

Number of Instances: 1

Available from RLX2 radios with firmware *RLX2_v0038_R* or later.

CIP Data Tag Name	Data Type	Access
RLX2_CRC.OS_Sig	DINT	Read
RLX2_CRC.Wireless_Sig	DINT	Read
RLX2_CRC.Config_Sig	DINT	Read
RLX2_CRC.Security_Sig	DINT	Read
RLX2_CRC.Web_Sig	DINT	Read
RLX2_CRC.SDCard_Sig	DINT	Read
RLX2_CRC.Rsvd1	DINT	Read
RLX2_CRC.Rsvd2	DINT	Read
RLX2_CRC.Rsvd2	DINT	Read
RLX2_CRC.Rsvd3	DINT	Read
RLX2_CRC.Rsvd4	DINT	Read
RLX2_CRC.Rsvd5	DINT	Read
RLX2_CRC.Rsvd6	DINT	Read
RLX2_CRC.Rsvd7	DINT	Read
RLX2_CRC.Rsvd8	DINT	Read
RLX2_CRC.Rsvd9	DINT	Read
RLX2_CRC.Rsvd10	DINT	Read
RLX2_CRC.Rsvd11	DINT	Read
RLX2_CRC.Rsvd12	DINT	Read
RLX2_CRC.Rsvd13	DINT	Read
RLX2_CRC.Rsvd14	DINT	Read

12 Appendix F - Master Channel-Frequency Table

The following table shows the channels/frequencies available in each RLX2-IHx series radio. Note that radios configured for FCC and ETSI regulatory domains do not have the same channels available. Also, some channels may have usage or power restrictions (for example, indoor or outdoor) in some locations.

Channel Number	Center Frequency (MHz)	FCC RLX2-XXX-A versions				ETSI RLX2-XXX-E versions			
		IHA	IHG	IHNF	IHW	IHA	IHG	IHNF	IHW
1	2412		✓	✓	✓			✓	✓
2	2417		✓	✓	✓			✓	✓
3	2422		✓	✓	✓			✓	✓
4	2427		✓	✓	✓			✓	✓
5	2432		✓	✓	✓			✓	✓
6	2437		✓	✓	✓			✓	✓
7	2442		✓	✓	✓			✓	✓
8	2447		✓	✓	✓			✓	✓
9	2452		✓	✓	✓			✓	✓
10	2457		✓	✓	✓			✓	✓
11	2462		✓	✓	✓			✓	✓
12	2467							✓	✓
13	2472							✓	✓
36	5180	✓		✓	✓			✓	✓
40	5200	✓		✓	✓			✓	✓
44	5220	✓		✓	✓			✓	✓
48	5240	✓		✓	✓			✓	✓
52 (DFS)	5260			✓				✓	
56 (DFS)	5280			✓				✓	
60 (DFS)	5300			✓				✓	
64 (DFS)	5320			✓				✓	
100 (DFS)	5500			✓				✓	
104 (DFS)	5520			✓				✓	
108 (DFS)	5540			✓				✓	
112 (DFS)	5560			✓				✓	
116 (DFS)	5580			✓				✓	
120 (DFS)	5600			✓				✓	
124 (DFS)	5620			✓				✓	
128 (DFS)	5640			✓				✓	

132 (DFS)	5660			✓				✓	
136 (DFS)	5680			✓				✓	
140 (DFS)	5700			✓				✓	
149	5745	✓		✓	✓				
153	5765	✓		✓	✓				
157	5785	✓		✓	✓				
161	5805	✓		✓	✓				
165	5825	✓		✓	✓				

13 Appendix G - Antenna Configuration

13.1 Antennas

There are several important electrical characteristics that you must consider when selecting antennas for a RLX2-IHx series radio.

- Antenna pattern
- Antenna gain
- Antenna polarity
- Antenna location, spacing, and mounting

13.1.1 Control Drawing

ProSoft Technology Control Drawing # 06/2514

Rev. 0

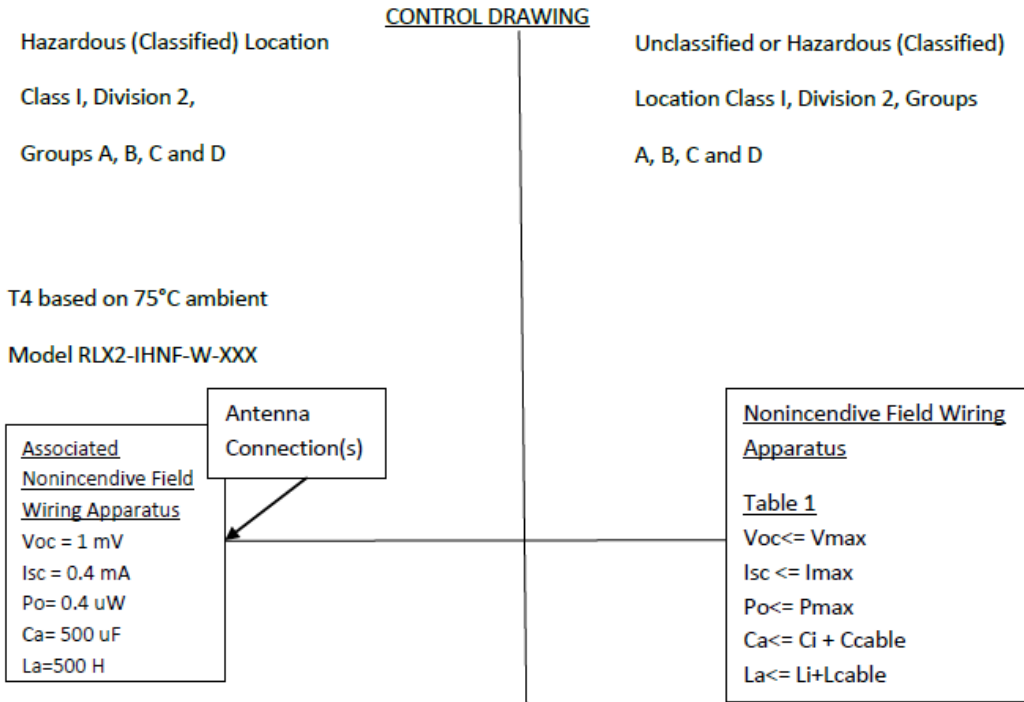

1. Selected Nonincendive Field wiring apparatus must be third party Listed as nonincendive field wiring apparatus for the application, and have entity parameters conforming with the table above.
2. The associated nonincendive field wiring apparatus may also be connected to simple apparatus as defined in Article 504.2 and installed and temperature classified in accordance with Article 504.10 (B) and 504.10 (D) of the national electrical code (NFPA 70), or other local codes as applicable.
3. The associated nonincendive field apparatus may be in a Zone 2 location, if so approved.

4. Capacitance and inductance of the field wiring from the nonincendive field wiring apparatus equipment to the associated nonincendive field wiring apparatus shall be calculated and must be included in the system calculation as shown in the above table. Cable capacitance C_{cable} , plus nonincendive field wiring apparatus capacitance C_i , must be less than the marked capacitance C_a (or C_o), shown on any associated apparatus used. The same applies for inductance (L_{cable} L_i and L_a or L_o respectively). Where the cable capacitance and inductance per foot are not known, the following values shall be used:

$$C_{cable} = 60 \text{ pF/ft}, \quad L_{cable} = 0.2 \text{ } \mu\text{H/ft}.$$

5. The associated apparatus must be connected to a suitable ground electrode per the national Electrical code (ANSI/NFPA 70), the Canadian electrical code or other local installation codes, as applicable the resistance of the ground path must be less than 1 ohm.
6. Where multiple circuits extend from the same piece of associated apparatus, they must be installed in separate cables or in one cable having suitable insulation. Refer to article 504.30 (B) of the National Electrical code (NFPA 70) and Instrument Society of America Recommended Practice ISA RP12.6 for installing intrinsically safe equipment.
7. This associated apparatus has not been evaluated for use in combination with other associated apparatus.

13.1.2 Antenna Pattern

Wireless devices transfer Information using electromagnetic energy radiated by one antenna and received by another antenna. The power radiated by most antennas is not uniform in all directions and has varying intensities. The power radiated by the antenna in various directions is called the *pattern* of the antenna. Mount each antenna so that the direction of strongest radiation points toward the other antenna or antennas with which it will exchange signals.

Complete antenna patterns are three-dimensional. Often only a two-dimensional slice of the pattern is shown when all the antennas of interest are located in roughly the same horizontal plane instead of above or below one another. A slice taken in a horizontal plane through the center (or looking down onto the pattern) is called the *azimuth pattern*. A slice taken in a vertical plan from the side is called the *elevation pattern*.

An antenna pattern with equal or nearly equal intensity in all directions is called *omnidirectional*. In two dimensions, an omnidirectional pattern appears as a circle (in three dimensions, an omnidirectional antenna pattern is a sphere, but no antenna has a true omnidirectional pattern in three dimensions). An antenna is considered omnidirectional if one of its two dimensional patterns, either azimuth or elevation pattern, is omnidirectional.

Beamwidth is an angular measurement of how strongly the power is concentrated in a particular direction. Beamwidth is a three dimensional quantity but can be broken into two-dimensional slices just like the antenna pattern. The beamwidth of an omnidirectional pattern is 360 degrees because the power is equal in all directions.

13.1.3 Antenna Gain

Antenna gain is a measure of how strongly an antenna radiates in its direction of maximum intensity compared to the strength of the radiation if the same power were applied to an omnidirectional antenna (one that radiated all of its power equally in all directions). In the antenna pattern, the gain is the distance to the furthest point on the pattern from the origin. For an omnidirectional pattern, the gain is 1, or equivalently 0 dB. The higher the antenna gain, the narrower the beamwidth, and *vice versa*.

The amount of power received by the receiving antenna is proportional to the transmitter power multiplied by the transmit antenna gain, multiplied by the receiving antenna gain. Therefore, you can make trade-offs between the antennas' gain and transmitting power. For example, doubling the gain of one of the antennas has the same effect as doubling the transmitting power. Doubling the gain for both antennas has the same effect as quadrupling the transmitting power.

13.1.4 Antenna Polarity

Antenna polarization refers to the direction in which the electromagnetic field lines point as energy radiates away from the antenna. In general, the polarization is elliptical. The simplest and most common form of this elliptical polarization is a straight line, or *linear polarization*.

An antenna only receives the portion of the transmitted power that has the same polarization as the receiving antenna polarization. For example:

- If the transmitting antenna polarization is in the vertical direction (vertical polarization), and the receiving antenna also has vertical polarization, the maximum amount of power possible is received.
- On the other hand, if the transmit antenna has vertical polarization and the receiving antenna has horizontal polarization, no power should be received. If the two antennas have linear polarizations oriented at 45° to each other, only half of the possible maximum power is received.

13.2 Antenna Types

Antenna types used with a RLX2-IHx series radio include whip, collinear array, yagi array, and parabolic reflector. See the *RLX2-IHx series Approved Antennas* (page 222) section for other types of approved antennas.

13.2.1 Whip Antennas

For RLX2-IHx series radios, use a 1/2 wave straight whip antenna or a 1/2 wave articulating whip (2 dBi) antenna. These antennas are the most common type in use today.

- They are approximately 5 inches long, and are likely to be connected directly to the client radio enclosure.
- These antennas do not require a ground plane.
- Articulating antennas and non-articulating antennas work in the same way.



13.2.2 Collinear Array Antennas

A collinear array antenna is typically composed of several linear antennas stacked on top of each other. The more stacked elements it has, the longer it is, and the more gain it has. The signal is connected at one end.



- The antenna pattern is torroidal. Its azimuthal beamwidth is 360° (omnidirectional). Its vertical beamwidth depends on the number of elements/length, and more elements produce a narrower beamwidth.
- The antenna gain depends on the number of elements/length, and more elements produce a higher gain. The typical gain for this antenna is 5 to 10 dBi.
- The antenna polarity is linear, or parallel to the length of the antenna.

13.2.3 Yagi Array Antenna

A yagi array antenna is composed of an array of linear elements, each parallel to one another and attached perpendicular to, and along the length of, a metal boom. The signal is connected to only one of the elements. Elements on one side of the connected element are longer and act as reflectors; elements on the other side are shorter and act as directors. This causes the antenna to radiate in a beam out of the end with the shorter elements. The pattern depends on the overall geometry, including the number of elements, element spacing, element length, and so on. Sometimes the antenna is enclosed in a protective tube hiding the actual antenna geometry (as shown in the image below).



- The antenna pattern is a beam pointed along the boom toward the end with the shorter elements. The beamwidth varies with antenna geometry but generally is proportional to the length (where longer length produces a narrower beam).
- The antenna gain varies with antenna geometry but generally is proportional to the length (where longer length produces higher gain). Typical values are 6 to 15dBi.
- The antenna polarity is Linear (parallel to the elements, perpendicular to the boom).

13.2.4 Parabolic Reflector Antennas

A parabolic reflector antenna consists of a parabolic shaped dish and a feed antenna located in front of the dish. The feed antenna radiates power toward the reflector. Due to the parabolic shape, the reflector concentrates the radiation into a narrow pattern, resulting in a beam with high gain.



- The antenna pattern is a beam pointed away from the concave side of the dish. Beamwidth and antenna gain vary with the size of the reflector and the antenna construction. Typical gain values are 15 to 30 dBi.
- The antenna polarity depends on the feed antenna polarization.

13.3 RLX2-IHx Approved Antennas

If you are located in the U.S. and Canada, use antennas that are specifically approved by the U.S. Federal Communications Commission (FCC) and Industry Canada for use with the RLX2-IHx series radios. Contact ProSoft Technology or visit www.prosoft-technology.com for a current list of approved antennas.

Antenna selection depends on whether the bi-directional amplifier is being used or not. For each approved antenna, there is a specified minimum distance the antennas must be separated from users for safe exposure limits, according to FCC part 2.1091.

13.3.1 Approved Antenna Table

Use the following approved antennas when the RLX2-IHx series radio module is connected directly to an antenna. See Approved Antennas with Power Amp (page 224) for a table of approved antennas with bi-directional power amplifiers.

Type	Pattern	Gain	Connector	Size (cm)	Min. distance from Body
1/2 Wave	Omni	2 dB	SMA-RP	7H x 1.5	20 cm
1/2 Wave art.	Omni	2 dB	SMA-RP	10H x 1.0	20 cm
Collinear Array	Omni	3 dB	SMA-RP	6H x 3.0	20 cm
Collinear Array, art.	Omni	5 dB	SMA-RP	19H x 1.0	20 cm
Collinear Array	Omni	5 dB	SMA-RP	19H x 1.0	20 cm
Collinear Array	Omni	8 dB	N-RP	43H x 1.6	20 cm
Collinear Array	Omni	9 dB	N-RP	43H x 1.6	20 cm
Collinear Array	Omni	12 dB	N-RP	106H x 4.0	25 cm
Patch	Directional	8 dB	SMA-RP	15.0H x 15.0	20 cm
Patch	Directional	11 dB	SMA-RP	22H x 12.7	22 cm
Patch	Directional	13 dB	N-RP	22H x 22	28 cm
Patch*	Directional	19 dB	N-RP	15.5 x 15.5	57 cm
Yagi	Directional	14 dB	N-RP	81L x 9.0	28 cm
Parabolic*	Directional	15 dB	N-RP	40H x 51W x 25D	36 cm
Parabolic*	Directional	19 dB	N-RP	58H x 66W x 26D	57 cm
Parabolic*	Directional	24 dB	N-RP	78H x 96W x 29D	100 cm

* Only allowed in a point-to-point network.

13.3.2 Approved Antennas in Europe/CE

In Europe/CE, the gain of the antenna connected to the RLX2-IHx series radio main antenna port, minus the antenna cable loss, must be less than 4 dB to stay below the 100-mW EIRP transmit power limit.

The AUX port on the radio is only used to receive; it never transmits.

Note: In France, the user is responsible for ensuring that the selected frequency channels comply with French regulatory standards. At the time of this printing, only channels 10 through 13 can be used in France.

13.3.3 Approved Antennas in Mexico

The gain of the antenna connected to the RLX2-IHx series radio main antenna port, minus the antenna cable loss, must be less than 12 dB to stay below the 650-mW EIRP transmit power limit.

Note: In Mexico, the user is responsible for ensuring that the selected frequency channels comply with Mexican regulatory standards. At the time of this printing, only channels 9 through 11 can be used outdoors (1 through 8 cannot); however, channels 1 through 11 can all be used indoors.

13.3.4 Approved Antennas with Power Amp

When the RLX2-IHx series radio is used in conjunction with the amplifier, the antennas are limited to antennas listed in the following table.

Type	Pattern	Gain	Connector	Size (cm)	Min. distance from Body
1/2 Wave	Omni	2 dB	SMA-RP	7H x 1.5	20 cm
1/2 Wave art.	Omni	2 dB	SMA-RP	10H x 1.0	20 cm
Collinear Array	Omni	3 dB	SMA-RP	6H x 3.0	20 cm
Collinear Array, art.	Omni	5 dB	SMA-RP	19H x 1.0	20 cm
Collinear Array	Omni	5 dB	SMA-RP	19H x 1.0	20 cm
Collinear Array	Omni	8 dB	N-RP	43H x 1.6	20 cm
Collinear Array	Omni	9 dB	N-RP	43H x 1.6	20 cm
Collinear Array*	Omni	12 dB	N-RP	106H x 4.0	25 cm
Patch	Directional	8 dB	SMA-RP	15.0H x 15.0	20 cm
Patch*	Directional	11 dB	SMA-RP	22H x 12.7	20 cm
Patch*	Directional	13 dB	N-RP	22H x 22	28 cm
Yagi*	Directional	14 dB	N-RP	81L x 9.0	28 cm

* Only allowed in a point-to-point network.

13.4 Antenna Location, Spacing, and Mounting

Consider the following points regarding RLX2-IHx series radio antenna location, spacing, and mounting:

- When placing antennas, ensure a clear line of sight between the Master radio's antenna and all of the other radio antennas.
- If the site contains obstructing terrain or structures, mount the antenna on a tower or rooftop to provide a line-of-sight path. This line-of-sight consideration becomes more important as the transmission path becomes longer.
- Mount the antennas as high off the ground as is practical for greater range.
- Mount the antennas away from massive structures. For example, radio signals bounce off metal walls, which can compromise a clear signal.
- Mount the antennas and install radios away from sources of RF interference.
- Use the shortest possible antenna cable length. Signals lose power over the length of the cable.
- Choose antennas that are appropriate for the network's intended function.
- If antennas are on radios on the same network, mount them with matching polarity. If the antennas are on separate networks, mount them with different antenna polarity; for example, mount one antenna vertically and the other horizontally.
- Space radios at least three feet (one meter) apart so they do not overload each other. If radio antennas must be near each other:
 - Mount omnidirectional antennas directly above each other.
 - Position directional antennas so they do not point at nearby antennas: place antennas side by side if they point in the same direction; place antennas back to back if they point in opposite directions.

14 Appendix H - FCC Emission Regulations

The charts in this section show the maximum emissions allowed for the FCC in the United States. These data should only be considered guidelines. Consult official FCC documents for the latest official regulations.

In the 2.4 GHz band, the maximum *Equivalent Isotropically Radiated Power* (EIRP) is 4W for multipoint links: that is, radios with omnidirectional antennas. Point-to-Point links using directional antennas are allowed higher EIRP.

14.1 2.4 GHz Band, Point-To-Multipoint

Maximum Power From Radio		Maximum Antenna Gain	Maximum EIRP	
dBm	mW	dBi	dBm	W
30	1000	6	36	4
27	500	9	36	4
24	250	12	36	4
21	125	15	36	4
18	63	18	36	4
15	32	21	36	4
12	16	24	36	4

14.2 2.4 GHz Band, Point-To-Point

Maximum Power From Radio		Maximum Antenna Gain	Maximum EIRP	
dBm	mW	dBi	dBm	W
30	1000	6	36	4.0
29	800	9	38	6.3
28	630	12	30	10.0
27	500	15	42	16.0
26	400	18	44	25.0
25	316	21	46	39.8
24	250	24	48	63.0
23	200	27	50	100.0
22	160	30	52	158.0

The FCC states that for every 1 dBi power reduction in the radio's transmitter output, the antenna gain may be increased by 3 dB.

14.3 5 GHz Bands, Point-To-Multipoint

5 GHz Band	Frequency Range (GHz)	Channels	Permitted Location	Maximum Power from Radio		Maximum EIRP	
				dBm	mW	dBm	W
UNII	5.15 to 5.25	36, 40, 44, 48	Indoor or Outdoor	30	1000	36	4
UNII-2	5.25 to 5.35	52, 56, 60, 64	Indoor or Outdoor	24	250	30	1
UNII-2 Extended	5.470 to 5.725	100, 104, 108, 112, 116, 120, 124, 128, 132, 136, 140	Indoor or Outdoor	24	250	30	1
UNII-3	5.725 to 5.825	149, 153, 157, 161, 165	Typical Outdoor	30	1000	36	4

14.4 5 GHz Bands, Point-To-Point

5 GHz Band	Frequency Range (GHz)	Channels	Permitted Location	Maximum Power from Radio		Maximum EIRP	
				dBm	mW	dBm	W
UNII	5.15 to 5.25	36, 40, 44, 48	Indoor or Outdoor	30	1000	53	200
UNII-2	5.25 to 5.35	52, 56, 60, 64	Indoor or Outdoor	24	250	30	1
UNII-2 Extended	5.470 to 5.725	100, 104, 108, 112, 116, 120, 124, 128, 132, 136, 140	Indoor or Outdoor	24	250	30	1
UNII-3	5.725 to 5.825	149, 153, 157, 161, 165	Indoor or Outdoor	30	1000	No limit	No limit

15 Appendix I - Compatibility with ProSoft RLXIB Series Radios

The RLX2-IHx series radios are 100% functionally compatible with ProSoft's legacy RLXIB-IHA, RLXIB-IHG, and RLXIB-IHW radio models. This allows customers with RLXIB series radios to add RLX2-IHx series radios to their existing networks without any reconfiguration of existing assets or problems with obsolescence. The main differences in the RLX2-IHx series radios are the following improvements:

- Different enclosure size for more efficient heat dissipation
- Faster, more efficient electronics that consume less power
- Gigabit Ethernet
- MicroSD memory cards for configuration data storage
- Internal temperature sensor

The RLX2-IHx series radios will acquire additional functionality as new firmware features are added. These new features will not be added to the RLXIB radios, but the RLX2-IHx series radios will continue to work with RLXIB radios using their existing functionality.

The RLX2-IHNF is an 802.11n device that does not have an RLXIB series equivalent. It *cannot* function as a Repeater or Master radio to ProSoft's RLXIB-IHxN series radio products. Specific differences by product are noted in the following table. Specifications that have not changed between the RLXIB and RLX2-IHx series radio products are not listed.

	RLXIB-IHA	RLX2-IHA	RLXIB-IHG	RLX2-IHG	RLXIB-IHW	RLX2-IHW	RLX2-IHNF
Dimensions	4.5/115 W x 4.6/117 H x 1.75/45 D (inches/mm)	5.82/148 W x 4.64/118 H x 1.48/38 D (inches/mm)	4.5/115 W x 4.6/117 H x 1.75/45 D (inches/mm)	5.82/148 W x 4.64/118 H x 1.48/38 D (inches/mm)	4.5/115 W x 4.6/117 H x 1.75/45 D (inches/mm)	5.82/148 W x 4.64/118 H x 1.48/38 D (inches/mm)	5.82/148 W x 4.64/118 H x 1.48/38 D (inches/mm)
Weight	1.1 lbs (499g)	1.1 lbs (499g)	1.1 lbs (499g)	1.1 lbs (499g)	1.06 lbs (479g)	1.06 lbs (479g)	1.1 lbs (499g)
Typical Power Consumption	< 9W	5.7W	< 9W	4.5W	< 6 W	4.5W	7.1W
Max Power Consumption	9W	10W	9W	8W	6W	8W	9W
Active antenna ports	1	1	1	1	1 Tx/Rx, 1 optional Rx only	1 Tx/Rx, 1 optional Rx only	1, 2, or 3, MIMO or independent antennas
Ethernet Speeds	10/100 MBit	10/100/1000 MBit	10/100 MBit	10/100/1000 MBit	10/100 MBit	10/100/1000 MBit	10/100/1000 MBit
NET and MOD Status LEDs		✓		✓		✓	✓
Fast Roaming		✓		✓		✓	✓
MicroSD card		✓		✓		✓	✓
Onboard temperature sensor		✓		✓		✓	✓
5 GHz band DFS channels							✓
Use RLXIB Firmware Image	✓		✓		✓		
Use RLX2-IHx series Firmware Image		✓		✓		✓	✓

16 Appendix J - Detailed Radio Specifications

16.1 RLX2-IHA Detailed Specifications

RLX2-IHA Radio

Frequency Band (Varies by country)	802.11a 5.150 GHz to 5.250 GHz (FCC/ETSI) 5.725 GHz to 5.850 GHz (FCC)
Wireless Standards	802.11a, 802.11i
Transmit Power (Programmable) (varies by country)	23 dBm (200 mW)
Channel Data Rates (Modulation)	802.11a: 54, 48, 36, 24, 18, 12, 9, 6 Mbps (OFDM)
Receiver Sensitivity (Typical)	-92 dBm @ 6 Mbps -84 dBm @ 24 Mbps -72 dBm @ 54 Mbps
Channel Selection	36, 40, 44, 48, 149, 153, 157, 161, 165
Security	WPA2 - 802.11i with 128 bit AES-CCM Legacy WPA TKIP, WEP support MAC ID filter, Admin password

Physical

Enclosure	Extruded aluminum with DIN and panel mount
Size (H x W x D)	14.8 x 11.8 x 3.8 cm 5.82 x 4.64 x 1.48 in
Shock	IEC 60068 2-27 (20g, 3-Axis)
Vibration	IEC 60068 2-6 (5g, 10Hz to 150Hz)
Ethernet Ports	(1) 10/100/1000 Base-T, RJ45 connector
Serial Port	(1) DB9 female (serial tunneling & encapsulation)
Antenna Port	(1) RP-SMA connector
Weight	1.1 lbs (499g)

Environmental

Operating Temperature	-40°C to +75°C (-40°F to +167°F)
Humidity	Up to 100% RH, with no condensation
External Power Power over Ethernet	10 VDC to 24 VDC 802.3af Compliant
Peak Power Consumption	< 7W

Agency Approvals & Certifications

Visit www.prosoft-technology.com for current wireless approval information.

16.2 RLX2-IHG Detailed Specifications

Radio

Frequency Band (Varies by country)	802.11g: 2.412 GHz to 2.462 GHz (FCC) 2.412 GHz to 2.472 GHz (ETSI)
Wireless Standards	802.11b, 802.11g, 802.11i
Transmit Power (Programmable) (varies by country)	Up to 24 dBm (250 mW)
Channel Data Rates (Modulation)	802.11g: (OFDM) Mbps 54, 48, 36, 24, 18, 12, 9, and 6 802.11b: (DSS) Mbps 11, 5.5, 2, and 1
Receiver Sensitivity (Typical)	-94 dBm @ 1 Mbps -92 dBm @ 11 Mbps -84 dBm @ 24 Mbps -72 dBm @ 54 Mbps
Channel Selection	802.11g: 1 to 11 (FCC), 1 to 13 (ETSI)
Security	WPA2 Enterprise – 802.11i AES w/RADIUS [PEAP, TTLS, TLS, EAP] WPA2 Personal – 802.11i AES w/Passphrase Legacy WPA TKIP, WEP support

Physical

Enclosure	Extruded aluminum with DIN and panel mount
Size (H x W x D)	14.8 x 11.8 x 3.8 cm 5.82 x 4.64 x 1.48 in
Shock	IEC 60068 2-27 (20g, 3-Axis)
Vibration	IEC 60068 2-6 (5g, 10Hz to 150Hz)
Ethernet Ports	(1) 10/100/1000 Base-T, RJ45 connector
Serial Port	(1) DB9 female (serial tunneling & encapsulation)
Antenna Port	(1) RP-SMA connector

Environmental

Operating Temperature	-40°C to +75°C (-40°F to +167°F)
Humidity	Up to 100% RH, with no condensation
External Power Power over Ethernet	10 VDC to 24 VDC 802.3af Compliant
Peak Power Consumption	< 7W

Agency Approvals & Certifications

Visit www.prosoft-technology.com for current wireless approval information.

16.3 RLX2-IHNF, -W, -WC Detailed Specifications

Radio

Specification	Frequency	Channel	
Frequency Band (Varies by country)	2.412 GHz to 2.462 GHz (FCC) 2.412 GHz to 2.472 GHz (ETSI)	1 to 11 1 to 13	
	5.150 GHz to 5.250 GHz (FCC/ETSI) 5.250 GHz to 5.350 GHz (FCC/ETSI)* 5.450 GHz to 5.725 GHz (FCC/ETSI)* 5.725 GHz to 5.850 GHz (FCC/ETSI) * DFS channels with RADAR detection	36 to 48 52 to 64* 100 to 140* 149 to 165	
Wireless Standards	802.11n, 802.11a, 802.11g, 802.11h (DFS), 802.11i (Security), 802.11e (QoS) 802.112Q (VLAN), 802.113af (PoE), IGMPv2		
Transmit Power (Programmable) *Subject to Regional Regulatory Limits	22 dBm @ MCS0, (802.11an/gn) 17 dBm @ MCS7, MCS15 (802.11an/gn) 24 dBm @ 6 Mbps (802.11a/g) 21 dBm @ 54 Mbps (802.11a/g)		
	Antenna Impact: 3 Antennas/MIMO: Use values above 2 Antennas: Subtract 2 dB from values above 1 Antenna: Subtract 5 dB from values above		
Channel data rates (802.11n)	MCS0 through MCS15, 1 Channel or 2 Channels with 1 Stream or 2 Streams		
	1 Channel	2 Channels	Rate
	6.5 Mbps	13.5 Mbps	MCS0
	65 Mbps	150 Mbps	MCS7
	13 Mbps	27 Mbps	MCS8
130 Mbps	300 Mbps	MCS15	
802.11b 802.11a/g	11, 5.5, 2, 1 Mbps 54, 48, 36, 24, 18, 12, 11, 9, 6, 5.5, 2, 1 Mbps		
Receiver Sensitivity (Typical)	-92 dBm @ MCS0, (802.11an/gn) -76 dBm @ MCS7, (802.11an) -71 dBm @ MCS15, (802.11an) -76 dBm @ MCS7, (802.11gn) -72 dBm @ MCS15, (802.11gn) -92 dBm @ 6 Mbps (802.11an/gn) -76 dBm @ 54 Mbps (802.11a/g)		
Security	WPA2 Personal/Enterprise – 802.11i AES WPA2 Personal – 802.11i AES w/ Passphrase Legacy WPA TKIP, WEP support MAC ID filter		

Physical

Enclosure	Extruded aluminum with DIN rail mount (RLX2-IHNF) Die-cast Aluminum with Pole Mount (RLX2-IHNF-W and RLX2-IHNF-WC)
Size (H x W x D)	14.8 x 11.8 x 3.8 cm (RLX2-IHNF) 5.82 x 4.64 x 1.48 in 29.2 x 17.8 x 7 cm (RLX2-IHNF-W and WC) 11.5 x 7 x 2.75 in
Shock	IEC 60068 2-27 (20g, 3-Axis)
Vibration	IEC 60068 2-6 (5g, 10Hz to 150Hz)

Ethernet Port	(1) 10/100 Base-T connector, shielded RJ45 IEEE 802.3, 802.3u, 802.3x Water/Dust Tight M12 Connector (RLX2-IHNF-W) 10/100/1000 Base-T connector, shielded RJ45 IEEE 802.3, 802.3u, 802.3x, 802.3af, Passive PoE Not 802.3at/PoE+ compatible Water/Dust Tight (RLX2-IHNF-WC) 10/100/1000 Base-T connector, shielded RJ45 IEEE 802.3, 802.3u, 802.3x, 802.3af
Antenna Port	(3) RP-SMA connector (3) N-Type Connectors (RLX2-IHNF-W and WC)
Personality Module	Industrial SD Memory Module No Personality Module on RLX2-IHNF-W or WC
Weight	1.1 lbs (499 g) (RLX2-IHNF) 3 lb 9 oz, 1.6 Kg – less cables and pole mounting bracket (RLX2-IHNF-W or WC)

Environmental

Operating Temperature	-40°F to +167°F (-40°C to +75°C) -40°F to +158°F (-40°C to +70°C), RLX2-IHNF Series B and C only
Humidity	Up to 100% RH, with no condensation
External Power PoE Injector	10 to 24 VDC 802.3af PoE Powered Device The RLX2-IHNF-WC has a 6-foot attached cable and a 6-foot attached CAT6 cable for PoE applications
Peak Power Consumption	< 9W (Series B), < 8W (Series C)

Agency Approvals & Certifications

Visit www.prosoft-technology.com for current wireless approval information.

16.4 RLX2-IHW Detailed Specifications

Radio

Frequency Band (Varies by country)	2.412 GHz to 2.462 GHz (FCC) 2.412 GHz to 2.472 GHz (ETSI) 5.150 GHz to 5.250 GHz (FCC/ETSI) 5.725 GHz to 5.850 GHz (FCC)
Wireless Standards	802.11a, 802.11b, 802.11g, 802.11i
Transmit Power (Programmable) (varies by country)	2.4 GHz: Up to 100 mW (20 dBm) 5 GHz: Up to 64 mW (18 dBm)
Channel data rates (Modulation)	802.11b: 11, 5.5, 2, 1 Mbps (DSSS, BPSK, QPSK, CCK) 802.11g: 54, 48, 36, 24, 18, 12, 9, 6 Mbps (OFDM) 802.11a: 54, 48, 36, 24, 18, 12, 9, 6 Mbps (OFDM)
Receiver Sensitivity (Typical)	-90 dBm @ 1 Mbps -85 dBm @ 11 Mbps -82 dBm @ 24 Mbps -75 dBm @ 54 Mbps
Channels Selection	1 to 13 (802.11b/g) 36, 40, 44, 48, 149, 153, 157, 161, 165 (802.11a)
Security	WPA2 - 802.11i with 128 bit AES-CCM Legacy WPA TKIP, WEP support MAC ID filter, Admin password

Physical

Enclosure	Extruded aluminum with DIN and panel mount
Size (H x W x D)	14.8 x 11.8 x 3.8 cm 5.82 x 4.64 x 1.48 in
Shock	IEC 60068 2-27 (20g, 3-Axis)
Vibration	IEC 60068 2-6 (5g, 10Hz to 150Hz)
Ethernet Ports	(1) 10/100/1000 Base-T, RJ45 connector
Serial Port	(1) DB9 female (serial tunneling & encapsulation)
Antenna Ports	(2) RP-SMA connectors (1 trans/rec, 1 rec only)

Environmental

Operating Temperature	-40°C to +75°C (-40°F to +167°F)
Humidity	Up to 100% RH, with no condensation
External Power PoE (Power over Ethernet)	10 to 24 VDC 802.3af Compliant
Peak Power Consumption	< 6W

Agency Approvals & Certifications

Visit www.prosoft-technology.com for current wireless approval information.

17 Appendix K - Application Examples

This chapter provides example applications using RLX2-IHx series radios.

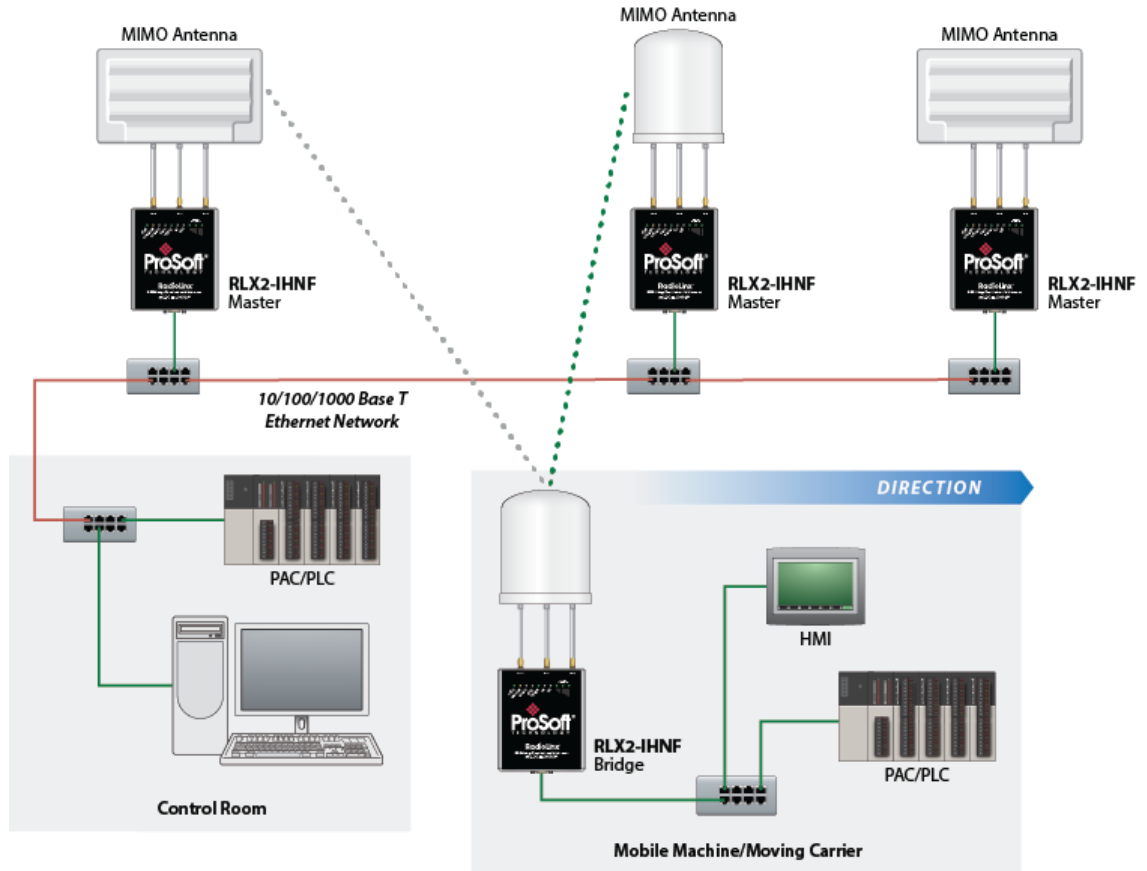

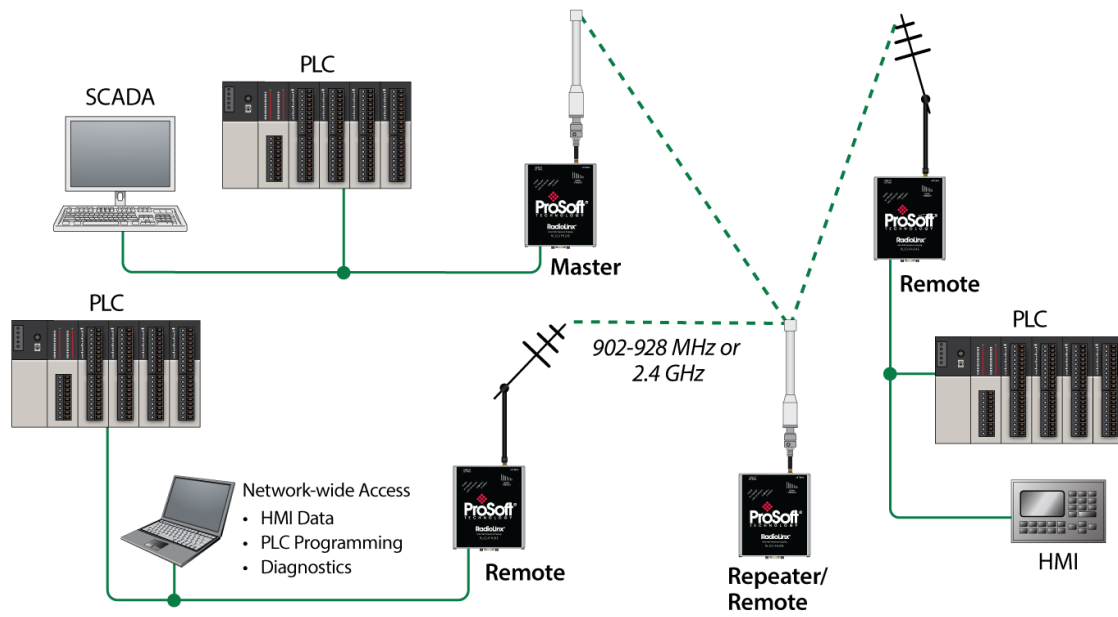

18 Support, Service & Warranty

18.1 Contacting Technical Support

ProSoft Technology, Inc. is committed to providing the most efficient and effective support possible. Before calling, please gather the following information to assist in expediting this process:

- 1 Product Version Number
- 2 System architecture
- 3 Network details

If the issue is hardware related, we will also need information regarding:

- 1 Module configuration and associated ladder files, if any
- 2 Module operation and any unusual behavior
- 3 Configuration/Debug status information
- 4 LED patterns
- 5 Details about the interfaced serial, Ethernet or Fieldbus devices

Note: For technical support calls within the United States, ProSoft's 24/7 after-hours phone support is available for urgent plant-down issues.

<p>North America (Corporate Location)</p> <p>Phone: +1.661.716.5100 info@prosoft-technology.com Languages spoken: English, Spanish REGIONAL TECH SUPPORT support@prosoft-technology.com</p>	<p>Europe / Middle East / Africa Regional Office</p> <p>Phone: +33.(0)5.34.36.87.20 france@prosoft-technology.com Languages spoken: French, English REGIONAL TECH SUPPORT support.emea@prosoft-technology.com</p>
<p>Latin America Regional Office</p> <p>Phone: +52.222.264.1814 latinam@prosoft-technology.com Languages spoken: Spanish, English REGIONAL TECH SUPPORT support.la@prosoft-technology.com</p>	<p>Asia Pacific Regional Office</p> <p>Phone: +60.3.2247.1898 asiapc@prosoft-technology.com Languages spoken: Bahasa, Chinese, English, Japanese, Korean REGIONAL TECH SUPPORT support.ap@prosoft-technology.com</p>

For additional ProSoft Technology contacts in your area, please visit:

<https://www.prosoft-technology.com/About-Us/Contact-Us>.

18.2 Warranty Information

For complete details regarding ProSoft Technology's TERMS & CONDITIONS OF SALE, WARRANTY, SUPPORT, SERVICE AND RETURN MATERIAL AUTHORIZATION INSTRUCTIONS, please see the documents at:

www.prosoft-technology/legal

19 Glossary of Terms

Symbols & Numeric

802.11

A group of wireless specifications developed by the IEEE. It details a wireless interface between devices to transport packet traffic.

802.11a

Operates in the 5 GHz frequency range with a maximum 54 Mbit/sec signaling rate.

802.11b

Operates in the most commonly used 2.4 GHz Industrial, Scientific, and Measurement (ISM) band. Provides signaling rates of up to 11 Mbit/sec using CCK modulation.

802.11g

Similar to 802.11b but supports signaling rates of up to 54 Mbit/sec using OFDM modulation. Operates in the heavily used 2.4 GHz ISM band.

802.11i

Sometimes called Wi-Fi Protected Access 2 (WPA 2). WPA 2 exclusively uses the 128-bit and above Advanced Encryption Standard (AES), along with 802.1x authentication and key management features.

802.11n

Uses higher modulation rates and packet aggregation to raise effective WLAN throughput to more than 100 Mbit/sec.

A

Access Point

A generic term for an 802.11 radio that "attaches" other 802.11 (clients) to a wired network. Some access points (APs) can also bridge to other APs.

Ad hoc Mode

Wireless network framework in which devices can communicate directly with one another without using an accesspoint or a connection to a regular network. RLX2-IHx series radio products do not support *Ad hoc* mode.

AES

Advanced Encryption Standard. New standard for encryption adopted by the U.S. government for secure communications.

Amplifier

A device connected to an antenna that increases the signal strength and amplifies weak incoming signals.

Antenna

A device connected to a wireless transceiver that concentrates transmitted and received radio waves to increase signal strength and thus the effective range of a wireless network.

ASCII

American Standard Code for Information Interchange. A communication mode in which each eight-bit byte in a message contains one ASCII character code. ASCII characters (or hexadecimal characters) are sometimes used as a key to encrypt data and ensure its secure transmission.

Association

Process whereby two 802.11 radios establish communications with each other. Requirements for communication include the same SSID (network names) and encryption settings.

Authenticate

The process of confirming the identity of someone connecting to a network.

Authentication Server

A back-end database server that confirms the identity of a supplicant to an authenticator in an 802.1x-authenticated network.

B**Band**

Another term for spectrum used to indicate a particular set of frequencies. Wireless networking protocols work in either the 2.4 GHz or the 5 GHz bands.

Bandwidth

(see Throughput)

Bridging Client, Radio Mode

A radio in *Bridging Client* mode can connect to any Access Point, and can support one multiple Ethernet device but can only bridge IP-based traffic. See also *Repeater, Radio Mode*.

C**CACT**

CACT is an acronym for *Channel Availability Check Time*, a parameter used in DFS channel selection. During DFS when a radio changes channels, it must listen for the CACT on the new channel before beginning operations. For most channels the CACT is 60 seconds.

Channel

One portion of the available radio spectrum that all devices on a wireless network use to communicate. Changing the channel on the access point/router can help reduce interference.

D**dBi**

Decibels referenced to an ideal isotropic radiator in free space; frequently used to express antenna gain

dBm

Decibels referenced to one milliwatt (mW); an absolute unit used to measure signal power (transmit) power output or received signal strength)

DCE

Data communications equipment. A modem, for example.

Decibel (dB)

A measure of the ratio between two signal levels; used to express gain (or loss) in a system.

Default Gateway

The IP address of a network router where data is sent if the destination IP address is outside the local subnet. The gateway is the device that routes the traffic from the local area network to other networks such as the Internet.

Device-to-Device Network (Peer-to-Peer Network)

Two or more devices that connect using wireless network devices without the use of a centralized wireless access point. Also known as a peer-to-peer network.

DFS

DFS stands for *Dynamic Frequency Selection*, a requirement for operation on certain frequencies in the 5 GHz band in many countries. When a radio operates on a DFS frequency, it must sense the presence of radar and automatically change to another channel if radar is detected.

DHCP

The dynamic host configuration protocol is an Internet protocol, similar to BootP, for automating the configuration of computers that use TCP/IP. DHCP can be used to automatically assign IP addresses, to deliver IP stack configuration parameters, such as the subnet mask and default router, and to provide other configuration information, such as the addresses for printer, time, and news servers.

Direct Sequence Spread Spectrum

A modulation mechanism that spreads the signal for a wide band, allowing reception even for overlapping data signals. 802.11b uses DSSS modulation.

Directional Antenna

Transmits and receives radio waves in a single direction.

Diversity Antenna

An antenna system that uses multiple antennas to reduce interference and maximize reception and transmission quality.

DTE

Data Terminal Equipment, for example, a computer or terminal.

Dual Band

A device that is capable of operating in two frequency bands. On a wireless network, dual-band devices are capable of operating in both the 2.4 GHz (802.11b/g) and 5 GHz (802.11a) bands.

E

EAP

Extensible Authentication Protocol. A protocol that provides an authentication framework for both wireless and wired Ethernet enterprise networks.

EIRP

Equivalent isotropically radiated power (EIRP) is the amount of power that would have to be emitted by an isotropic antenna (that evenly distributes power in all directions and is a theoretical construct) to produce the peak power density observed in the direction of maximum antenna gain.

Encryption

Method of scrambling data so that only the intended viewers can decipher and understand it.

F

Firmware

Firmware is the embedded software code that runs in hardware containing a CPU (similar to the BIOS in a personal computer). This is distinguished from the IH Browser software that is installed on the Configuration PC.

Fresnel Zone

An elliptical area on either side of the straight line of sight that must also be clear for a long-range wireless network to work.

Full-Duplex

A communications circuit or system designed to simultaneously transmit and receive two different streams of data. Telephones are an example of a full-duplex communication system. Both parties on a telephone conversation can talk and listen at the same time. If both talk at the same time, their two signals are not corrupted.

G

Gain, Antenna

The amount by which an antenna concentrates signal strength in a wireless network.

Gateway

In wireless terms, a gateway is an access point with additional software capabilities such as providing NAT and DHCP and access to a Wide Area network (WAN), Internet or other main network.

Guard Interval (GI)

An interval of time between data symbols during transmission. The guard interval time for 802.11a/b/g systems is fixed at 800 microseconds. 802.11n devices can also use a 400 microsecond guard interval, falling back to 800 microseconds if excessive data corruption is detected.

H

Half-Duplex

A communications circuit or system designed to transmit and receive data, but not both simultaneously. CB or walkie-talkie radios are an example of a half-duplex communication system. Either parties on a radio conversation may talk or listen; but both cannot talk at the same time without corrupting each other's signal. If one operator is sending, the other must be receiving to have successful communication.

Hz

Hertz. The international unit for measuring frequency equivalent to the older unit of cycles per second. One megahertz (MHz) is one million hertz. One gigahertz (GHz) is one billion hertz. The standard US electrical power frequency is 60 Hz. 802.11a devices operate in the 5 GHz band; 802.11b and g devices operate in the 2.4 GHz band.

I

IEEE

Institute of Electrical and Electronics Engineers, Inc. IEEE is a professional organization with members in over 175 countries and is an authority in technical areas such as computer engineering and telecommunications. IEEE developed the 802.11 specifications.

IP Address

A 32-bit identification number for each node on an Internet Protocol network. These addresses are represented as four sets of 8-bit numbers (numbers from 0 to 255), separated by periods ("dots").

Networks using the TCP/IP protocol route messages based on the IP address of the destination. Each number can be 0 to 255. For example, 192.168.0.100 could be an IP address. Each node on the network must have a unique IP address.

K

Key

A set of information (often from 40 to as much as 256 bits in size) that is used as a seed to an encryption algorithm to encrypt (scramble) data. Ideally, the key must also be known by the receiver to decrypt the data.

L

LAN

Local Area Network. A system of connecting PCs and other devices within the same physical proximity for sharing resources such as internet connections, printers, files, and drives. When Wi-Fi is used to connect the devices, the system is known as a wireless LAN or WLAN.

LED

Light-emitting diode.

Line of Sight (LoS)

A clear line from one antenna to another in a long-range wireless network.

M

MAC ID

Media Access Control address. Every device has its own MAC address which is a unique identifier used to unambiguously identify the source and destination of any packet on the network.

Mbps

Megabits per second, or a million bits per second. A measure of data rate.

Megahertz

A measure of electromagnetic wave frequency equal to one million hertz. Often abbreviated as MHz and used to specify the radio frequency used by wireless devices.

MIC

Message Integrity Check. One of the elements added to the TKIP standard. A signature is added by each radio on each packet it transmits. The signature is based on the data in the packet, a 64-bit value (key) and the MAC address of the sender. The MIC allows the receiving radio to verify (check) that the data is not forged or altered.

MIMO

Multiple Input Multiple Output refers to using multiple antennas in a Wi-Fi device to improve performance and throughput. MIMO technology takes advantage of a characteristic called multipath, which occurs when a radio transmission starts out at Point A and the reflects off or passes through surfaces or objects before arriving, via multiple paths, at Point B. MIMO technology uses multiple antennas to collect and organize signals arriving via these paths.

Modbus

The Modbus protocol provides the internal standard that the MODICON® controllers use for parsing messages. During communications on a Modbus network, the protocol determines how each controller knows its device address, recognizes a message addressed to it, determines the kind of action to be taken, and extracts any data or other information contained in the message. If a reply is required, the controller constructs the reply message and sends it using Modbus protocol.

Modem

MODulator-DEModulator, a device that converts digital signals to analog signals and vice-versa. Analog signals can be transmitted over communications links such as telephone lines.

N**Network**

A series of stations or nodes connected by some type of communication medium. A network may consist of a single link or multiple links.

Node

An address or software location on the network.

Non-Occupancy Period

The time during which a radio cannot return to a frequency where radar was detected. This time is typically 30 minutes. Typically a radio will not return to a channel where radar was previously detected unless absolutely necessary.

Null Modem Cable

A specialty cross-communication cable with female connectors on each end used for direct connection between DTE devices when no modems are present. Commonly used as a quick and inexpensive way to transfer files between two PCs without installing a dedicated network card in each PC.

P

Panel Antenna

An antenna type that radiates in only a specific direction. Panel antennas are commonly used for point-to-point situations. Sometimes called Patch antennas.

Parabolic Antenna

An antenna type that radiates a very narrow beam in a specific direction. Parabolic antennas offer the highest gain for long-range point-to-point situations.

Peer-to-Peer Network

Each radio in a Peer-to-Peer network has the ability to receive data from, and transmit data to, any other radio in the network.

Point-to-Multipoint

A wireless network in which one device (the access point or Master Bridge) serves multiple other devices associated to it.

Point-to-Point Network

A network consisting of a single Master radio and a single Remote radio.

Poll

A method of electronic communication.

Power Supply

A device that supplies electrical power to the I/O chassis containing the processor, coprocessor, or other modules.

Protocol

The language or packaging of information that is transmitted between nodes on a network.

Q

QoS

Quality of Service. Required to support wireless multimedia applications and advanced traffic management. QoS enables Wi-Fi access points to prioritize traffic and optimize the way shared network resources are allocated among different applications.

R

Range

The distance covered by a wireless network radio device. Depending on the environment and the type of antenna used, Wi-Fi signals can have a range of up to a several miles.

Repeater

A Repeater is a device used to extend the range of a Wi-Fi signal. Placed at the edge of signal reception, a repeater can receive and re-transmit the signal.

Repeater, Radio Mode

A RLX2-IHx series radio in *Repeater* mode can only connect to other ProSoft radios, but can bridge any number of Ethernet network devices attached to it. It also simultaneously functions as an access point, allowing other wireless devices to associate to it. See also *Client, Radio Mode*.

RS-232

Recommended Standard 232; the standard for serial binary signals between DTE and DCE devices.

S**Sector Antenna**

An antenna type that radiates in only a specific direction. Multiple sector antennas are commonly used in point-to-multipoint situations.

Signal Diversity

A process by which two antennas are used to send and receive, combining their results for better effect.

Signal Loss

The amount of signal strength that's lost in antenna cable, connectors, and free space. Signal loss is measured in decibels (dB). Also referred to as gain loss.

Signal Strength

The strength of the radio waves received at a wireless device.

Site Survey

A comprehensive facility study performed by network managers to ensure that planned service levels will be met when a new wireless LAN or additional WLAN segments to an existing network are deployed. Site surveys are usually performed by a radio frequency engineer and used by systems integrators to identify the optimum placement of access points to ensure that planned levels of service are met. Site surveys are sometimes conducted following the deployment to ensure that the WLAN is achieving the necessary level of coverage. Site surveys can also be used to detect rogue access points.

Spectrum

A range of electromagnetic frequencies.

Spread Spectrum

A form of wireless communication in which a signal's frequency is deliberately varied. This increases bandwidth and lessens the chances of interruption or interception of the transmitted signal.

SSID

Service Set Identifier is a sequence of characters unique to a specific network or network segment that's used by the network and all attached devices to identify themselves and allow devices to connect to the correct network when one or more than one independent network is operating in nearby areas.

Subnet Mask

A mask used to determine what subnet an IP address belongs to. An IP address has two components: the network address, and the host (node or device) address; for example the IP address 150.215.017.009. Assuming this is part of a Class B network (with a subnet mask of 255.255.0.0), the first two numbers (150.215) represent the Class B network address, and the second two numbers (017.009) identify a particular host on this network.

T

TKIP

Temporal Key Integrity Protocol. A wireless security encryption mechanism in Wi-Fi Protected Access (WPA).

U

UART

Universal Asynchronous Receiver/Transmitter

W

WDS

Wireless Distribution System. Enables access points to communicate with one another in order to extend the range of a wireless networks. Used in 802.11g based access points.

WEP

Wired-Equivalent Privacy protocol was specified in the original IEEE 802.11 standard to provide a WLAN with a minimal level of security and privacy comparable to a typical wired LAN, using data encryption.

Wi-Fi

A certification mark managed by a trade group called the Wi-Fi Alliance. Wi-Fi certification encompasses numerous standards including 802.11a, 802.11b, 802.11g, WPA, and more. Equipment must pass compatibility testing to receive the Wi-Fi mark.

Wi-Fi CERTIFIED™

The certification standard designating IEEE 802.11-based wireless local area network (WLAN) products that have passed interoperability testing requirements developed and governed by the Wi-Fi alliance.

Wi-Fi Interoperability Certificate

A statement that a product has passed interoperability testing and will work with other Wi-Fi CERTIFIED products.

Wi-Fi Protected Setup

Wi-Fi Protected Setup™ (previously called Wi-Fi Simple Config) is an optional certification program developed by the Wi-Fi alliance designed to ease set up of security enabled Wi-Fi networks in the home and small office environment. Wi-Fi Protected Setup supports methods (pushing a button or entering a PIN into a wizard-type application) that are familiar to most consumers to configure a network and enable security.

Wireless Gateway

A term used to differentiate between an access point and a more-capable device that can share an internet connection, serve DHCP, and bridge between wired and wireless networks.

Wireless Network

A network of connected using a centralized wireless access point.

WLAN

Wireless Local Area Network. A type of local area network in which data is sent and received via high-frequency radio waves rather than cables or wires.

WPA

Wi-Fi Protected Access is a data encryption specification for 802.11 wireless networks that replaces the weaker WEP. It improves on WEP by using dynamic keys, Extensible Authentication Protocol to secure network access, and an encryption method called Temporal Key Integrity Protocol (TKIP) to secure data transmissions.

WPA2

An enhanced version of WPA. It is the official 802.11i standard. It uses Advanced Encryption Standard instead of TKIP. AES supports 128-bit, 192-bit, and 256-bit encryption keys.

Y

Yagi Antenna

An antenna type that radiates in only a specific direction. Yagi antennas are used in point-to-point situations.

Index

2

- 2.4 GHz Band, Point-To-Multipoint • 226
- 2.4 GHz Band, Point-To-Point • 226

5

- 5 GHz Bands, Point-To-Multipoint • 227
- 5 GHz Bands, Point-To-Point • 227

A

- About RLX2-IHx series Industrial Hotspot Products • 14
- About This Manual • 14
- Access Settings • 78
- Active Antennas
 - RLX2-IHW • 84
 - RLX-IHNF • 84
- Adding the Radio to RSLogix 5000 • 183
- Advanced Wireless Settings • 80, 95
- Antenna Gain • 218
- Antenna Location, Spacing, and Mounting • 225
- Antenna Pattern • 218
- Antenna Polarity • 219
- Antenna Port Connections • 17, 30
- Antenna Spacing Requirements for User Safety • 8
- Antenna Types • 219
- Antennas • 215
- Appendix A - Adding a Radio to RSLogix 5000 • 183
- Appendix B - Radio Hardware • 193
- Appendix C - RLX2-IHx 5 GHz Radio DFS Support • 201
- Appendix D - RLX2-IHx series Virtual LAN (VLAN) Functionality • 116, 205
- Appendix E - EtherNet/IP and Modbus TCP/IP Support • 208
- Appendix F - Master Channel-Frequency Table • 213
- Appendix G - Antenna Configuration • 17, 61, 68, 141, 215
- Appendix H - FCC Emission Regulations • 226
- Appendix I - Compatibility with ProSoft RLXIB Series Radios • 14, 228
- Appendix J - Detailed Radio Specifications • 16, 230
- Appendix K - Application Examples • 235
- Apply Changes • 58
- Approved Antenna Table • 223
- Approved Antennas in Europe/CE • 223
- Approved Antennas in Mexico • 224
- Approved Antennas with Power Amp • 223, 224
- Assigning a Temporary IP Address • 38, 39, 44, 45, 46, 47, 51, 131, 132
- Assigning an IP address • 45, 47, 50, 78

B

- Basic Wireless Settings • 67, 95

- Before You Begin • 14

C

- Cable Break Detection • 106
- Cancelling Changes • 58
- Certificate Management • 76
- Changing IH Browser Columns in List View • 123
- Changing Password Settings • 91
- Checking the Ethernet Cable • 177
- Collinear Array Antennas • 220
- Configuration Help • 56
- Configuring a Bridging Client Radio • 47, 69
- Configuring a Client Radio • 23, 47, 50, 69
- Configuring a Radio - Detailed Configuration • 40, 52, 54
- Configuring a Radio - Getting Started • 39, 40, 52, 53, 132, 179
- Configuring a Repeater Radio • 45, 69
- Configuring Advanced Network Settings • 97
- Configuring Advanced Settings • 79
- Configuring Basic Settings • 66
- Configuring Parent Link Settings • 87, 92, 123
- Configuring Quality of Service (QoS) Settings • 113
- Configuring Serial Settings • 107
- Configuring VLAN Settings • 115, 117, 120
- Connecting to the Radio Configuration Utility • 40, 43, 45, 47, 51, 54, 77, 124, 133, 135
- Contacting Technical Support • 182, 237
- Content Disclaimer • 2
- Control Drawing • 216

D

- Defining the Scan Parameters in the IH Browser • 122
- Designer Functional Specifications • 27
- Detecting 802.11 Access Points • 29, 140
- DFS Radio Operations • 201, 203
- Diagnostics and Troubleshooting • 177

E

- Encryption Type • 71, 73
- Enterprise Mode Settings • 71, 75
- Ethernet Cable Configuration • 198, 199
- Ethernet Cable Configuration (all other radios) • 200
- Ethernet Cable Configuration (RLX2-IHNF-W) • 199
- Ethernet Cable Specifications • 198
- EtherNet/IP™ Server Support • 210

F

- Factory Defaults • 58
- Finding Missing Radios • 182
- Freezing the Display in the IH Browser • 123

G

- General Features • 16
- Glossary of Terms • 238

H

- Hiding the Toolbar and Status Bar in the IH Browser • 129

How to Contact Us • 2

I

IGMP Settings • 98
IH Browser System Requirements • 21
Important Safety Information • 3
Importing and Exporting IH Browser Data • 128
Importing the Add-On Instruction • 187
Improving Signal Quality • 28
Industrial Hotspot Bench Test Kit (RLX-IHBTK) • 21
Industry Canada Requirements: • 4
Installation Questions • 24
Installing IH Browser Software • 22
Installing the ProSoft Wireless Designer • 23, 24
Installing the RadioLinx Industrial Hotspot Browser • 21
IP address, Assigning • 45, 47, 50, 78

L

LED Display • 16, 178
List View Columns • 123, 124, 130
Location Services Settings • 88

M

MAC Filter • 71, 72
Making Power and Data Connections • 27, 30, 31
Max Data Rate • 83
Modbus Memory Map Diagnostic Information • 208
Modbus TCP/IP Server Support • 208

N

Network Planning • 23, 30

P

Package Contents • 19, 53
Packet Delineation Settings • 110
Parabolic Reflector Antennas • 222
Parent Selection Method Settings • 93
Password, Changing • 91
Personality Module Settings • 53, 58, 89
Ping Options Dialog Box • 136, 137
Pinging Devices on the Network • 136, 137
Planning the Physical Installation • 25
Port Settings • 112
Port/Radio-based VLAN Tagging with Managed Switches • 206
Port/Radio-based VLAN Tagging without Managed Switches • 207
Preparing the Configuration Environment • 30
Printing the View in the IH Browser • 128
Product Overview • 14
ProSoft Wireless Designer • 25

R

Radio Power Requirements (All other radios) • 196
Radio Power Requirements (RLX2-IHNF-W) • 194
Radio Power-Up • 37
Rapid Spanning Tree Functionality • 101, 103
Read-Only Fields • 55
Recommended Antennas • 7

Refreshing the Display in the IH Browser • 38, 44, 122, 182

Remote IP Settings • 109
Repeater Parameters Settings • 94
Replacing an Existing Radio • 30, 53, 89
Resetting a RLX2-IHx series Radio • 30, 40, 54, 134, 180
Resetting All Other Radios • 181
Resetting IH Browser Columns • 123
Resetting the RLX2-IHNF-W and RLX2-IHNF-WC • 180
RLX2 Controller Tags • 191
RLX2.CONTROL • 191
RLX2.STATUS • 192
RLX2-IHA Detailed Specifications • 230
RLX2-IHA, -IHG, -IHNF, -IHW • 19
RLX2-IHG Detailed Specifications • 231
RLX2-IHNF, RLX2-IHA, RLX2-IHG, RLX2-IHW • 4
RLX2-IHNF, -W, -WC Detailed Specifications • 232
RLX2-IHNF-W • 5, 19
RLX2-IHNF-W Cables (sold separately) • 20
RLX2-IHNF-W Radio Connections • 31
RLX2-IHNF-WC • 5, 6, 20
RLX2-IHNF-WC Radio Connections • 34
RLX2-IHW Detailed Specifications • 234
RLX2-IHW, IHNF, IHG, IHA Radio Connections • 31
RLX2-IHx series Approved Antennas • 219, 222
RLX2-IHx series Quick Setup • 30
Roam Control Settings • 85

S

Selecting a DFS 5 GHz Channel • 202
Serial Encapsulation Mode Setting • 108
Setting the Event Log Filter • 143, 144
Setting the Radio IP Address in the IH Browser • 38, 131
Setting Up a Master Radio • 43, 68
SNMP Agent • 105
Spanning Tree Protocol • 101
Start Here • 14
Starting the IH Browser • 22, 29, 37, 121, 133
STP Settings • 96, 99, 101
Support, Service & Warranty • 237
Switching between List and Topology Views • 123, 124, 127

T

Temporary IP Address, Assigning • 39
Testing the Network Installation • 25, 27
Topology View Description • 123, 127
Transparent Support of VLAN Tags (802.1Q) • 205

U

Unable to scan for AP's error message • 181
Updating the Radio Firmware • 60, 135
Using the IH Browser to Configure Radios • 27, 37
Using the IH Browser to Manage your Radios • 22, 29, 37, 121

V

Viewing a Radio's Configuration • 52
Viewing Additional Data in the IH Browser • 128, 133
Viewing Available Parents for a Radio • 60, 61, 140
Viewing Ethernet Nodes in the IH Browser • 139
Viewing Network Data in the IH Browser • 138, 146
Viewing Parent Radios in the IH Browser • 145
Viewing Radio Status • 59
Viewing the Port Table in the IH Browser • 142
Viewing the Radio Address Table • 60, 63
Viewing the Radio Event Log in the IH Browser • 143
Viewing the Radio Port Status • 60, 64, 103
Viewing the Radio Properties • 124, 129
Viewing the Radios in the IH Browser • 37, 121
Viewing the Scan List in the IH Browser • 140, 145
Viewing Wireless Clients in the IH Browser • 138, 146,
151

W

Warranty Information • 237
WEP Key • 71, 73, 74
Whip Antennas • 219
Wireless Security Settings • 70, 72, 96

Y

Yagi Array Antenna • 221
Your Feedback Please • 2