

Multiturn absolute encoder PSM58

- Industrial standard housing Ø58 mm
- PROFIBUS interface
- 30 Bit multiturn
- Speed transfer
- Extended scaling functions
- Programmable limit switches
- Commissioning mode
- Recessed hollow shaft



Function

This series of PROFIBUS rotary encoders is based on the modern fast technology of singleturn sampling and the mechanical gear box of the multiturn unit. The absolute encoder corresponds to the PROFIBUS profile for encoders, order no. 3.062. Operation is supported based on Class 1 and Class 2.

For operation based on Class 1, position data and diagnostic data bytes 1 ... 16 are available. In addition, the direction of the code can be selected as either cw ascending (clockwise rotation, code course ascending) or cw descending (clockwise rotation, code course descending).

If the rotary encoder is operated according to Class 2, additional functions to those from Class 1 are available. These include scaling of the resolution per revolution and the overall resolution, as well as the preset function. In addition, expanded diagnostic reporting is supported. Besides, the rotary encoder offers extended functionalities such as speed transfer, extended scaling functions, programmable limit switches and a commissioning mode.

The removable connecting hood contains a slide switch for setting the terminating resistor and the rotary switches for setting the address. Assign a fixed address and bus termination to the encoder with this switches.

The absolute encoder is mounted directly onto the application shaft, without any coupling. Rotation of the absolute encoder is prevented by a torque rest.

Dimensions

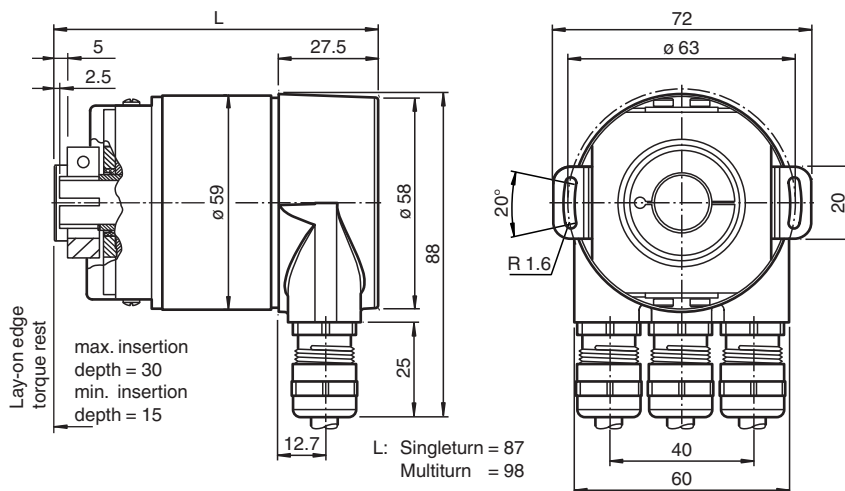

Technical Data

General specifications	
Detection type	photoelectric sampling
Device type	Multiturn absolute encoder
Functional safety related parameters	
MTTF _d	70 a
Mission Time (T _M)	20 a
L ₁₀	1.9 E+11 at 6000 rpm and 20/40 N axial/radial shaft load

Release date: 2020-09-28 Date of issue: 2020-09-28 Filename: t49155_eng.pdf

Refer to "General Notes Relating to Pepperl+Fuchs Product Information".

Pepperl+Fuchs Group
www.pepperl-fuchs.com

USA: +1 330 486 0001
fa-info@us.pepperl-fuchs.com

Germany: +49 621 776 1111
fa-info@de.pepperl-fuchs.com

Singapore: +65 6779 9091
fa-info@sg.pepperl-fuchs.com

PF PEPPERL+FUCHS

Technical Data

Diagnostic Coverage (DC)		0 %
Electrical specifications		
Operating voltage	U_B	10 ... 30 V DC
No-load supply current	I_0	max. 230 mA at 10 V DC max. 100 mA at 24 V DC
Power consumption	P_0	max. 2.5 W
Time delay before availability	t_v	< 1000 ms
Linearity		± 2 LSB at 16 Bit, ± 1 LSB at 13 Bit, $\pm 0,5$ LSB at 12 Bit
Output code		binary code
Code course (counting direction)		programmable, cw ascending (clockwise rotation, code course ascending) cw descending (clockwise rotation, code course descending)
Interface		
Interface type		PROFIBUS
Resolution		
Single turn		up to 16 Bit
Multiturn		14 Bit
Overall resolution		up to 30 Bit
Transfer rate		0.0096 ... 12 MBit/s
Standard conformity		PNO profile 3.062, RS-485
Connection		
Terminal compartment		in removable housing cover
Standard conformity		
Degree of protection		DIN EN 60529, IP65 IP66 (with shaft seal)
Climatic testing		DIN EN 60068-2-30, no moisture condensation
Emitted interference		EN 61000-6-4:2007
Noise immunity		EN 61000-6-2:2005
Shock resistance		DIN EN 60068-2-27, 100 g, 6 ms
Vibration resistance		DIN EN 60068-2-6, 10 g, 10 ... 2000 Hz
Approvals and certificates		
UL approval		cULus Listed, General Purpose, Class 2 Power Source
Ambient conditions		
Operating temperature		-40 ... 85 °C (-40 ... 185 °F)
Storage temperature		-40 ... 85 °C (-40 ... 185 °F)
Mechanical specifications		
Material		
Combination 1		housing: powder coated aluminum flange: aluminum shaft: stainless steel
Combination 2 (Inox)		housing: stainless steel flange: stainless steel shaft: stainless steel
Mass		approx. 600 g (combination 1) approx. 1200 g (combination 2)
Rotational speed		max. 12000 min ⁻¹
Moment of inertia		30 gcm ²
Starting torque		≤ 3 Ncm (version without shaft seal)
Tightening torque, fastening screws		max. 1.8 Nm
Shaft load		
Angle offset		$\pm 0,9^\circ$
Axial offset		static: $\pm 0,3$ mm, dynamic: $\pm 0,1$ mm
Radial offset		static: $\pm 0,5$ mm, dynamic: $\pm 0,2$ mm

Release date: 2020-09-28 Date of issue: 2020-09-28 Filename: t49155_eng.pdf

Refer to "General Notes Relating to Pepperl+Fuchs Product Information".

Pepperl+Fuchs Group
www.pepperl-fuchs.com





USA: +1 330 486 0001
fa-info@us.pepperl-fuchs.com

Germany: +49 621 776 1111
fa-info@de.pepperl-fuchs.com

Singapore: +65 6779 9091
fa-info@sg.pepperl-fuchs.com

 PEPPERL+FUCHS

Accessories

	AH 58-B1CA-2BW	
	ACC-PACK-ABS-_S_58 ø15	Accessories set for Ø58 absolut rotary encoder with recessed hollow shaft 15 mm
	ACC-PACK-ABS-_S_58 ø14	Accessories set for Ø58 absolut rotary encoder with recessed hollow shaft 14 mm
	ACC-PACK-ABS-_S_58 ø12	Accessories set for Ø58 absolut rotary encoder with recessed hollow shaft 12 mm
	ACC-PACK-ABS-_S_58 ø10	Accessories set for Ø58 absolut rotary encoder with recessed hollow shaft 10 mm

Connection

Terminal	Explanation
⊥	Ground connection for power supply
B (left)	Data line B (pair 1), Bus In
A (left)	Data line A (pair 1), Bus In
(-)	0 V
(+)	10 V ... 30 V
B (right)	Data line B (pair 2), Bus Out
A (right)	Data line A (pair 2), Bus Out
(-)	0 V
(+)	10 V ... 30 V
	The supply lines only have to be connected once (regardless to which terminal). The outgoing bus is being uncoupled while the terminal resistor is on.

The arrangement of the terminals is shown in the section commissioning.

Commissioning

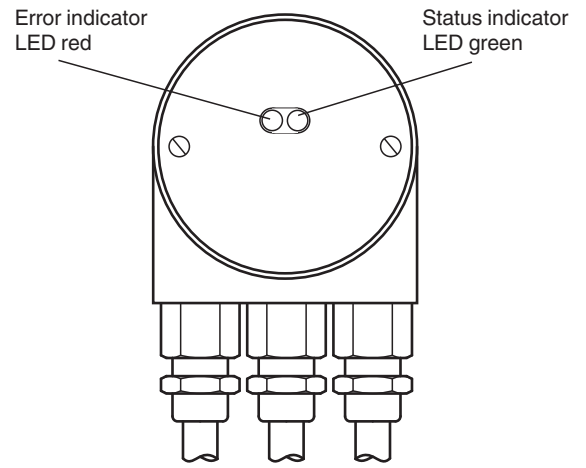
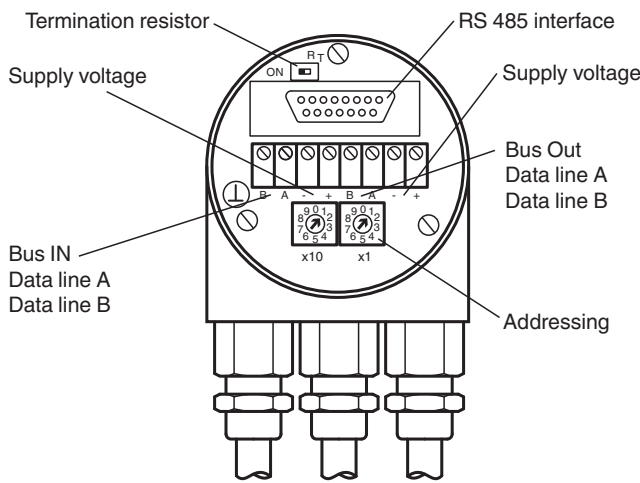

Adjusting the participant address

The participant address can be adjusted with the rotary switches. The address can be defined between 1 and 99, and may only be assigned once.

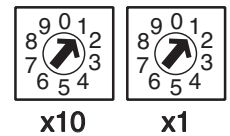

Adjusting the termination resistor

The terminating resistor R_T (220 Ω) can be connected to the circuit by means of the switch:

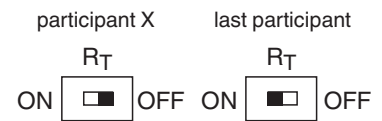

Release date: 2020-09-28 Date of issue: 2020-09-28 Filename: t49155_eng.pdf

ALED-indicators

LED red	LED green	Meaning
off	off	No voltage supply
on	on	Encoder ready, no configuration data received. possible reasons: - wrong address adjusted - wrong bus wiring
on	flashing	Parameterising or configuration error. Encoder receives data of incorrect length or inconsistent data. possible reason: - adjusted encoder resolution exceeds
flashing	on	Encoder ready, no communication with master (i.e. wrong address setting)
on	off	Data timeout (> 40 s). (i.e. data lines interrupted)
off	on	Normal operation, Data Exchange Mode
off	flashing	Installation Mode in Data Exchange Mode.

Function Principle

Principle of data transmission

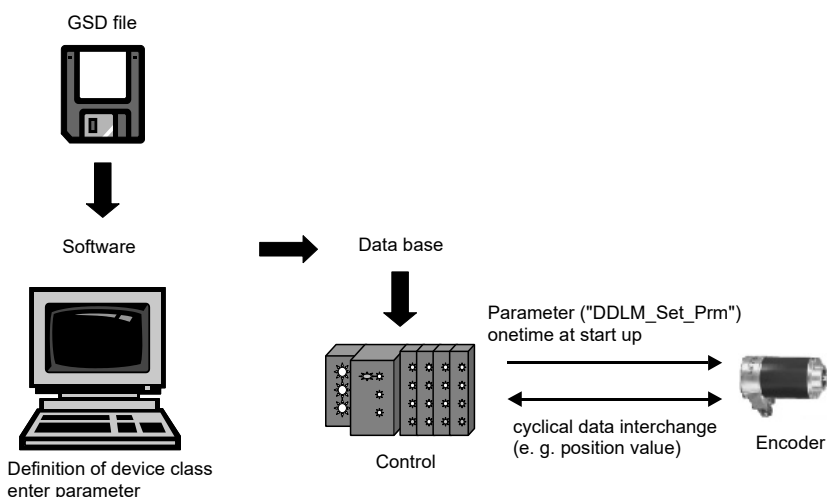

Parameterization

Parameter table encoder classes P+F 2.1 and P+F 2.2

Octet number (Byte)	Parameter	Bit number
1...8	PROFIBUS standard parameters	
9	Direction of rotation	0
	Class 2 functionality	1
	Commissioning Diagnostics	2
	Scaling function	3
	Reserved	4
	Reserved	5
	Activate manufacturer specific parameters (Octet 26)	6
	Reserved	7
10 ... 13	Desired measuring steps (reference: Octet 26, Bit 0 and 1)	
14 ... 17	Overall resolution	
18 ... 25	Reserved	
26	Reference for desired measuring steps	0
		1
	Activate commissioning mode	2
	Reduced diagnosis	3
	Reserved	4
	Activate lower software limit switch	5
	Activate upper software limit switch	6

Release date: 2020-09-28 Date of issue: 2020-09-28 Filename: t49155_eng.pdf

Refer to "General Notes Relating to Pepperl+Fuchs Product Information".

	Activation of the parameters from Octet 27	7
27 ... 30	Lower limit switch	
31 ... 34	Upper limit switch	
35 ... 38	Physical measuring steps	
39	Reserved	0
	Rotary encoder type (singleturn or multiturn)	1
	Reserved	2
	Reserved	3
	Selection of the unit for speed transfer	4
		5
	Reserved	6
Reserved	7	

Type Code

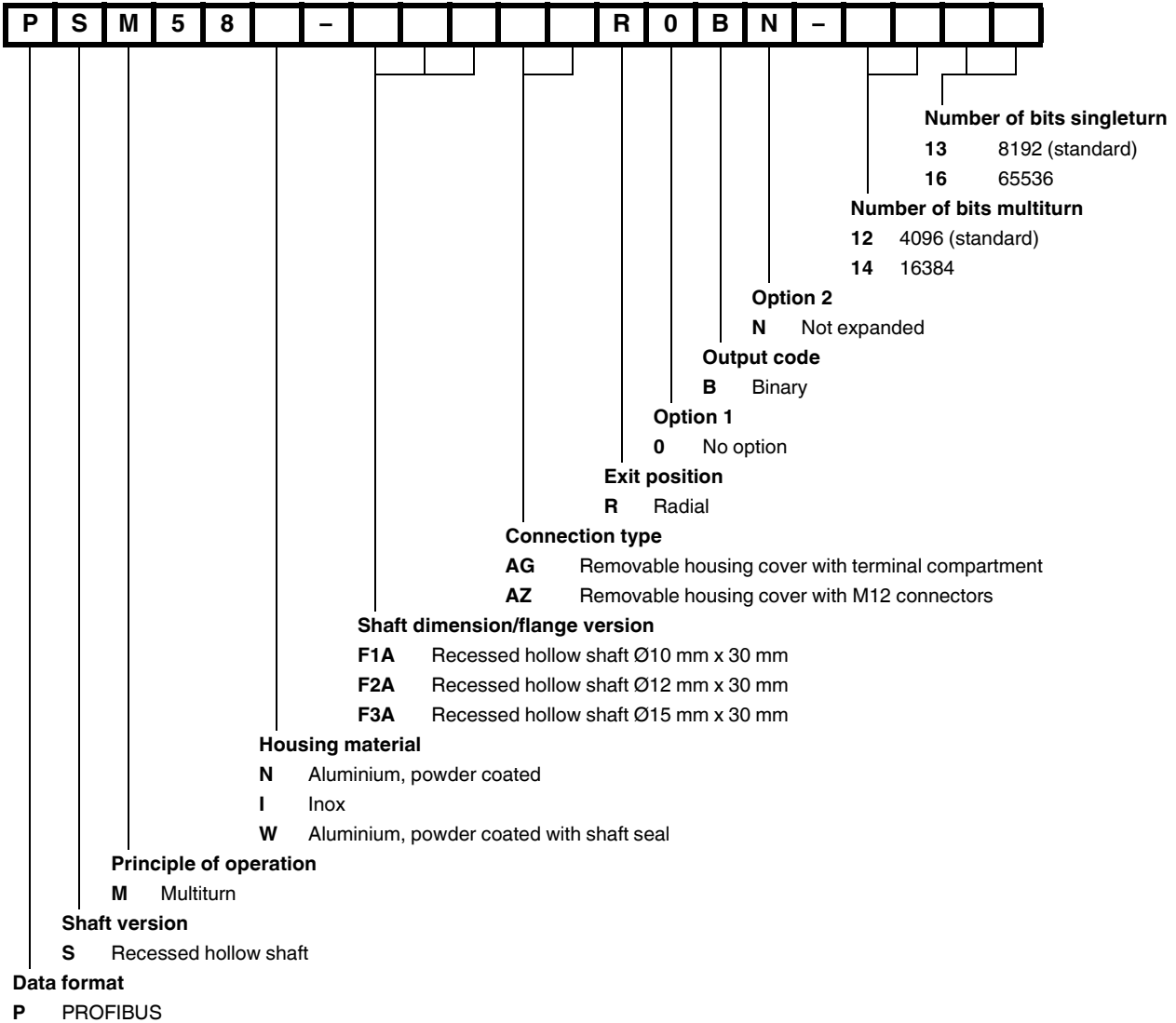

Additional Information

Installation instructions



Note

The connecting hoods of the former rotary encoder generation do no longer fit for the new PROFIBUS rotary encoders, as the dimensions have been changed. Please use nothing but the connecting hoods with error and status indication.

Anti-interference measures

Release date: 2020-09-28 Date of issue: 2020-09-28 Filename: t49155_eng.pdf

Refer to "General Notes Relating to Pepperl+Fuchs Product Information".

The use of highly sophisticated microelectronics requires a consistently implemented anti-interference and wiring concept. This becomes all the more important the more compact the constructions are and the higher the demands are on the performance of modern machines.

The following installation instructions and proposals apply for "normal industrial environments". There is no ideal solution for all interfering environments.

When the following measures are applied, the encoder should be in perfect working order:

- Termination of the serial line with a 120 Ω resistor (between Receive/Transmit and Receive/Transmit) at the beginning and end of the serial line (e. g. the control and the last encoder).
- The wiring of the encoder should be laid at a large distance to energy lines which could cause interferences.
- Cable cross-section of the screen at least 4 mm².
- Cable cross-section at least 0,14 mm².
- The wiring of the screen and 0 V should be arranged radially, if and when possible.
- Do not kink or jam the cables.
- Adhere to the minimum bending radius as given in the data sheet and avoid tensile as well as shearing load.

Operating instructions

Every encoder manufactured by Pepperl+Fuchs leaves the factory in a perfect condition. In order to ensure this quality as well as a faultless operation, the following specifications have to be taken into consideration:

- Avoid any impact on the housing and in particular on the encoder shaft as well as the axial and radial overload of the encoder shaft.
- The accuracy and service life of the encoder is guaranteed only, if a suitable coupling is used.
- The operating voltage for the encoder and the follow-up device (e. g. control) has to be switched on and off simultaneously.
- Any wiring work has to be carried out with the system in a dead condition.
- The maximum operating voltages must not be exceeded. The devices have to be operated at extra-low safety voltage.

Notes on connecting the electric screening

The immunity to interference of a plant depends on the correct screening. In this field installation faults occur frequently. Often the screen is applied to one side only, and is then soldered to the earthing terminal with a wire, which is a valid procedure in LF engineering. However, in case of EMC the rules of HF engineering apply.

One basic goal in HF engineering is to pass the HF energy to earth at an impedance as low as possible as otherwise energy would discharge into the cable. A low impedance is achieved by a large-surface connection to metal surfaces.

The following instructions have to be observed:

- Apply the screen on both sides to a "common earth" in a large surface, if there is no risk of equipotential currents.
- The screen has to be passed behind the insulation and has to be clamped on a large surface below the tension relief.
- In case of cable connections to screw-type terminals, the tension relief has to be connected to an earthed surface.
- If plugs are used, metallised plugs only should be fitted (such as sub D plugs with metallised housing). Please observe the direct connection of the tension relief to the housing.

Advantage:	metallised connector,	
shield	clamped with the strain	
relief	clamp	
Disadvantage:	soldering shield on	

Safety instructions

Please observe the national safety and accident prevention regulations as well as the subsequent safety instructions in these operating instructions when working on encoders.

If failures cannot be remedied, the device has to be shut down and has to be secured against accidental operation.

Repairs may be carried out only by the manufacturer. Entry into and modifications of the device are not permissible.

Tighten the clamping ring only, if a shaft has been fitted in the area of the clamping ring (hollow shaft encoders).

Tighten all screws and plug connectors prior to operating the encoder.

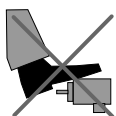

Do not stand on the encoder!

Release date: 2020-09-28 Date of issue: 2020-09-28 Filename: t49155_eng.pdf

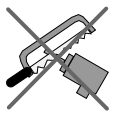

Do not remachine the drive shaft!

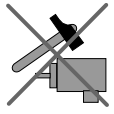

Avoid impact!



Do not remachine the housing!

Release date: 2020-09-28 Date of issue: 2020-09-28 Filename: t49155_eng.pdf