

# C40E-1204CB010

C4000 Advanced

**SAFETY LIGHT CURTAINS**

**SICK**  
Sensor Intelligence.

Illustration may differ

### Ordering information

Resolution	Scanning range	Protective field height	System part	Type	Part no.
40 mm	21 m	1,200 mm	Receiver	C40E-1204CB010	1018821

Other models and accessories → [www.sick.com/C4000\\_Advanced](http://www.sick.com/C4000_Advanced)



### Detailed technical data

#### Features

<b>System part</b>	Receiver
<b>Resolution</b>	40 mm
<b>Scanning range</b>	21 m
<b>Protective field height</b>	1,200 mm
<b>Response time</b>	11 ms <sup>1)</sup>
<b>Synchronization</b>	Optical synchronisation

<sup>1)</sup> Without beam coding, without blanking, no cascaded systems. Other response times see operating instructions.

#### Safety-related parameters

<b>Type</b>	Type 4 (IEC 61496-1)
<b>Safety integrity level</b>	SIL3 (IEC 61508) SILCL3 (EN 62061)
<b>Category</b>	Category 4 (EN ISO 13849)
<b>Performance level</b>	PL e (EN ISO 13849)
<b>PFH<sub>D</sub> (mean probability of a dangerous failure per hour)</b>	15 * 10 <sup>-9</sup> (EN ISO 13849) 43 * 10 <sup>-9</sup> (EN ISO 13849) 63 * 10 <sup>-9</sup> (EN ISO 13849)
<b>T<sub>M</sub> (mission time)</b>	20 years (EN ISO 13849)
<b>Safe state in the event of a fault</b>	At least one OSSD is in the OFF state.

#### Functions

	Functions	Delivery status
<b>Protective operation</b>	✓	
<b>Restart interlock</b>	✓	External
<b>External device monitoring (EDM)</b>	✓	Deactivated
<b>Beam coding</b>	✓	Uncoded
<b>Configurable scanning range</b>	✓	0 m ... 6 m
<b>Fixed blanking</b>	✓	Deactivated
<b>Floating blanking</b>	✓	Deactivated

	Functions	Delivery status
Safe SICK device communication via EFI	✓	

### Functions in combination with UE402

Bypass	✓
Operating mode switching	✓
PSDI mode	✓

### Interfaces

<b>System connection</b>	
Connection type	Hirschmann male connector M26, 12-pin
Direction of cable connection	Straight
Permitted cable length	50 m <sup>1)</sup>
Conductor cross-section	0.75 mm <sup>2</sup>
<b>Configuration connection</b>	
Connection type	Female connector M8, 4-pin
Configuration method	PC with CDS (Configuration and Diagnostic Software)
<b>Display elements</b>	
7-segment display	
<b>Fieldbus, industrial network</b>	
Integration via EFI gateways	CANopen <sup>2)</sup> Ethernet PROFIBUS DP PROFIBUS PROFI-safe PROFINET PROFI-safe
Integration via Flexi Soft safety controller	CANopen <sup>3)</sup> DeviceNet™ EtherCAT® EtherNet/IP™ Modbus TCP PROFIBUS DP PROFINET

<sup>1)</sup> Depending on load, power supply and wire cross-section. The technical specifications must be observed.

<sup>2)</sup> For a suitable EFI-gateway see modules and gateways in the accessory section of connection systems.

<sup>3)</sup> For additional information on Flexi Soft -> [www.sick.com/Flexi\\_Soft](http://www.sick.com/Flexi_Soft).

### Electrical data

<b>Protection class</b>	III (IEC 61140)
<b>Supply voltage <math>V_S</math></b>	24 V DC (19.2 V ... 28.8 V) <sup>1)</sup>
<b>Residual ripple</b>	≤ 10 % <sup>2)</sup>
<b>Output signal switching devices (OSSDs)</b>	
Type of output	2 PNP semiconductors, short-circuit protected, cross-circuit monitored <sup>3)</sup>
ON state, switching voltage HIGH	24 V DC ( $V_S - 2.25$ V DC ... $V_S$ )
OFF state, switching voltage LOW	≤ 2 V DC
Current-carrying capacity per OSSD	≤ 500 mA

<sup>1)</sup> The external voltage supply must be capable of buffering brief mains voltage failures of 20 ms as specified in EN 60204-1. Suitable power supplies are available as accessories from SICK.

<sup>2)</sup> Within the limits of  $V_S$ .

<sup>3)</sup> Applies to the voltage range between -30 V and +30 V.

## Mechanical data

<b>Dimensions</b>	See dimensional drawing
<b>Housing cross-section</b>	48 mm x 40 mm
<b>Weight</b>	2,560 g

## Ambient data

<b>Enclosure rating</b>	IP65 (EN 60529)
<b>Ambient operating temperature</b>	0 °C ... +55 °C
<b>Storage temperature</b>	-25 °C ... +70 °C
<b>Air humidity</b>	15 % ... 95 %, Non-condensing
<b>Vibration resistance</b>	EN 60068-2-6
<b>Shock resistance</b>	10 g, 16 ms (EN 60068-2-27)

## Classifications

<b>ECl@ss 5.0</b>	27272704
<b>ECl@ss 5.1.4</b>	27272704
<b>ECl@ss 6.0</b>	27272704
<b>ECl@ss 6.2</b>	27272704
<b>ECl@ss 7.0</b>	27272704
<b>ECl@ss 8.0</b>	27272704
<b>ECl@ss 8.1</b>	27272704
<b>ECl@ss 9.0</b>	27272704
<b>ECl@ss 10.0</b>	27272704
<b>ECl@ss 11.0</b>	27272704
<b>ETIM 5.0</b>	EC002549
<b>ETIM 6.0</b>	EC002549
<b>ETIM 7.0</b>	EC002549
<b>UNSPSC 16.0901</b>	46171620

Dimensional drawing (Dimensions in mm (inch))

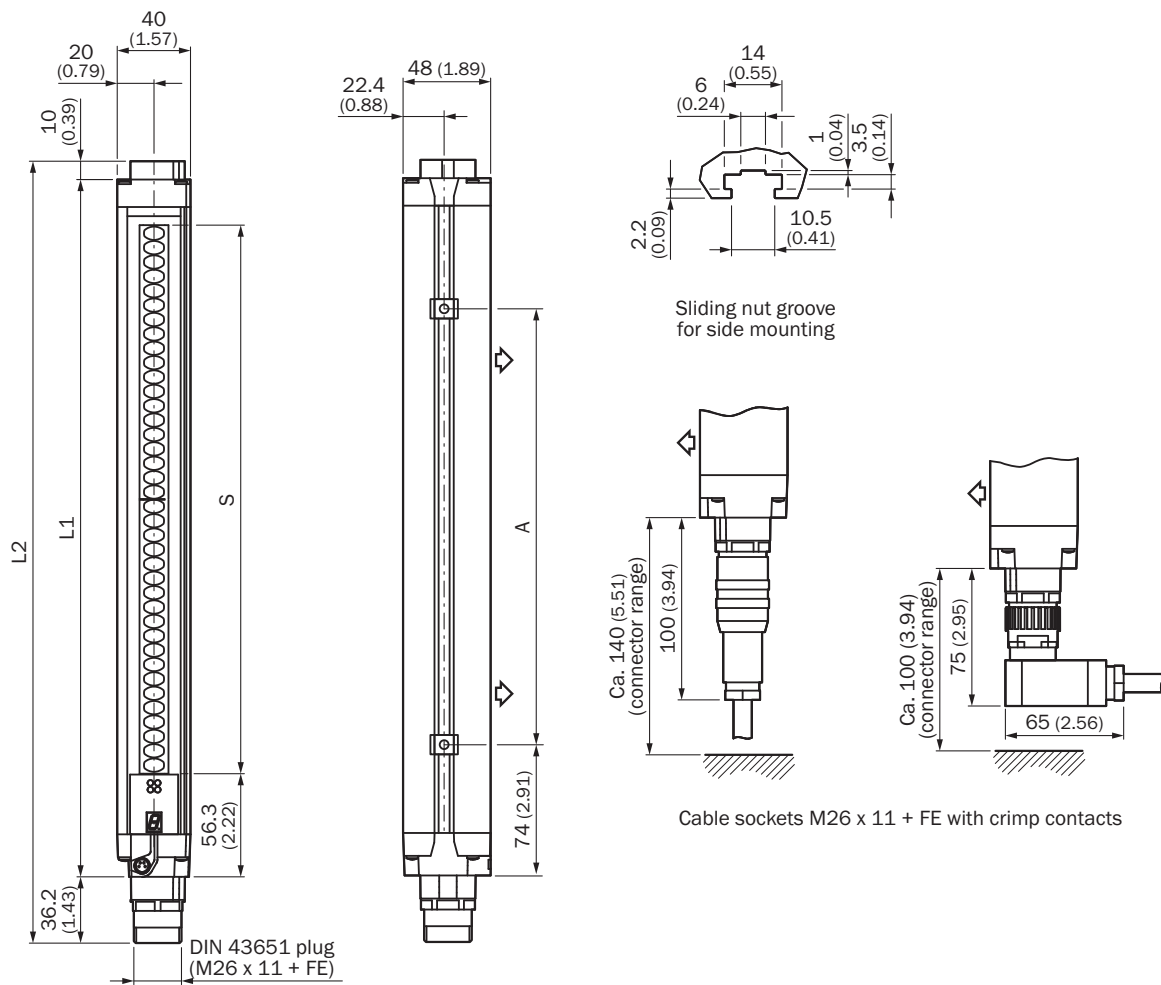
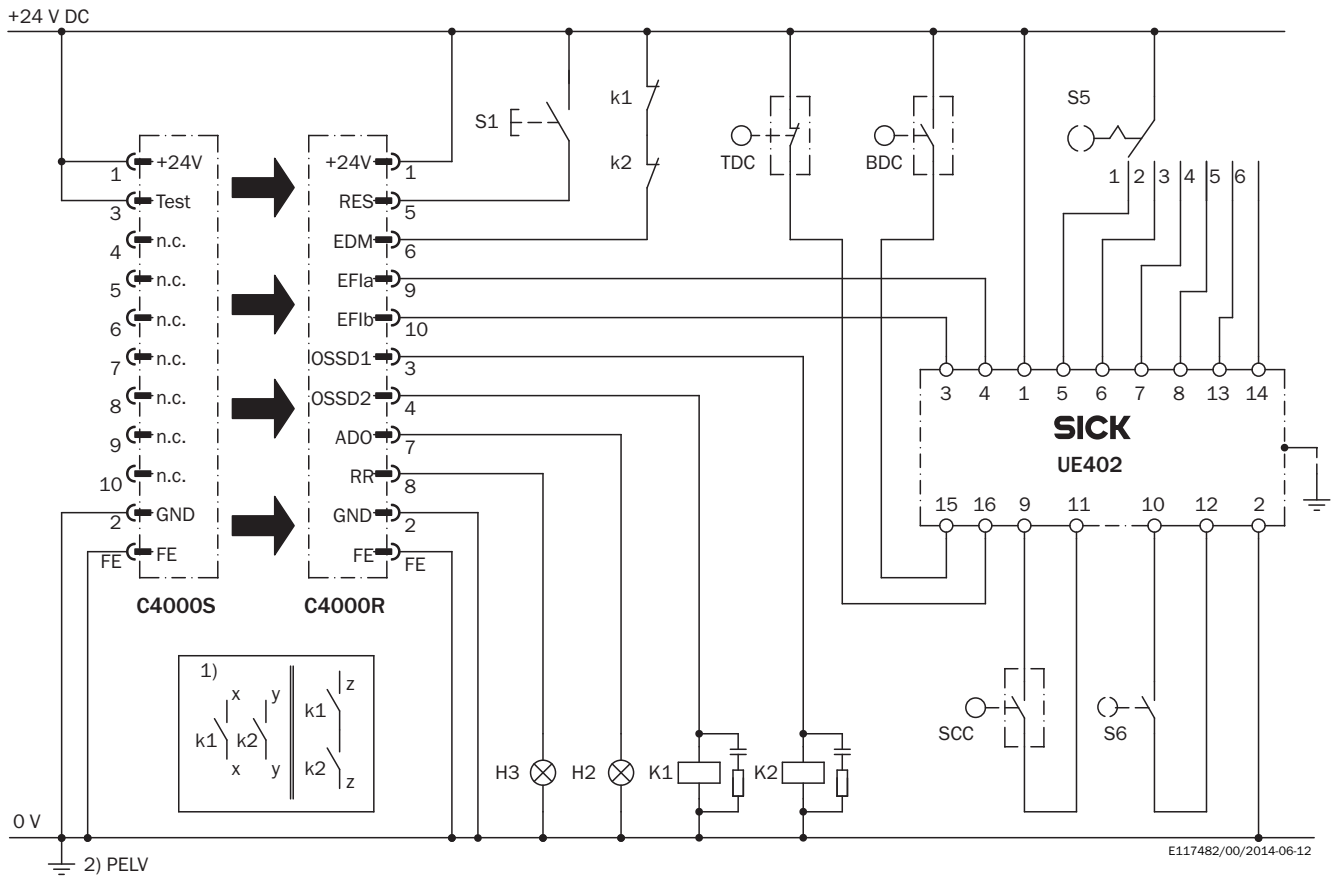

Illustration sender (receiver mirror image)

Protective field height S	L1	L2	A
300	381	427	224
450	532	578	374
600	682	728	524
750	833	879	674
900	984	1.030	824
1.050	1.134	1.180	974
1.200	1.283	1.329	1.124
1.350	1.435	1.481	1.274
1.500	1.586	1.632	1.424
1.650	1.736	1.782	1.574
1.800	1.887	1.933	1.724

### Connection diagram

C4000 Advanced safety light curtain on UE402 safety switching amplifier



#### Task

Integration of a C4000 Advanced safety light curtain with UE402 in a controller. Six configurable operating modes with restart interlock and external device monitoring. PSDI mode with TDC, BDC, SCC. Teachable blanking areas.

#### Operating characteristics

If no object is detected in the active protective field and the K1 and K2 contactors are in the de-energized position, the H3 lamp flashes as a prompt to operate S1 control switch. The OSSDs are switched on when S1 is operated (button is pressed and released). These outputs activate K1 and K2 contactors. Upon the detection of an object in an active protective field, the OSSDs deactivate K1 and K2 contactors.

#### Fault analysis

The incorrect functioning of one of the K1 or K2 contactors does not result in the loss of the shutdown function. OSSD cross-circuits and short-circuits are detected and lead to the inhibited state (lock-out). On manipulation (e.g., jamming) of the S1 button, the system does not enable the output current circuits.

#### Comments

<sup>1)</sup> Output circuits: These contacts are to be connected to the controller such that, with the output circuit open, the dangerous state is disabled. For categories 4 and 3, this integration must be dual-channel (x/y paths). Single-channel integration in the control (z path) is only possible with a single-channel control and by taking the risk analysis into account.

<sup>2)</sup> PELV in accordance with the requirements in EN 60204-1 / 6.4

Please see the operating instructions for the related devices to obtain information on the effects of the functions with configurable parameters. This information is to be observed.

Recommended accessories

Other models and accessories → [www.sick.com/C4000\\_Advanced](http://www.sick.com/C4000_Advanced)

	Brief description	Description	Type	Part no.
<b>Mounting brackets and plates</b>				
	4 pieces, Mounting kit 1, mounting bracket, rigid, L-shaped, including fixing screws and washers		BEF-3WNGBAST4	7021352
<b>Terminal and alignment brackets</b>				
	4 pieces, Mounting kit 6, side bracket, rotatable, Zinc diecast		BEF-1SHABAZN4	2019506
	4 pieces, Omega bracket, rotatable, fixable with only one screw, for mounting on the swivel mount		BEF-2SMMEAAL4	2044847
	4 pieces, Stainless steel bracket, rotatable, stainless steel 1.4350, stainless steel 1.4301		BEF-2SMMEAES4	2023708
	4 pieces, Mounting kit 2, rotatable, swivel mount, Polyamide PA6		BEF-2SMMEAKU4	2019659
<b>Plug connectors and cables</b>				
	Head A: female connector, M26, 12-pin, straight Head B: Flying leads Cable: PVC, unshielded, 5 m Without EFI: Pin 9 and 10 not connected		DOL-0610G05M075KM1	2046888
	Head A: female connector, M26, 12-pin, straight Head B: Flying leads Cable: PVC, unshielded, 10 m Without EFI: Pin 9 and 10 not connected		DOL-0610G10M075KM1	2046889
	Head A: female connector, M26, 12-pin, straight Head B: Flying leads Cable: PVC, unshielded, 5 m		DOL-0612G05M075KM0	2022545
	Head A: female connector, M26, 12-pin, straight Head B: Flying leads Cable: PVC, unshielded, 10 m		DOL-0612G10M075KM0	2022547
	Head A: female connector, M26, 12-pin, straight Head B: Flying leads Cable: PVC, unshielded, 15 m		DOL-0612G15M075KM0	2022548
	Head A: female connector, M26, 12-pin, straight Head B: Flying leads Cable: PVC, unshielded, 20 m		DOL-0612G20M075KM0	2022549
	Head A: male connector, M8, 4-pin, straight Head B: male connector, USB-A, straight Cable: PVC, unshielded, 2 m		DSL-8U04G02M025KM1	6034574
	Head A: male connector, M8, 4-pin, straight Head B: male connector, USB-A, straight Cable: PVC, unshielded, 10 m		DSL-8U04G10M025KM1	6034575

	Brief description	Description	Type	Part no.
	Head A: female connector, M26, 12-pin, straight Cable: unshielded 12 crimping contacts enclosed		DOS-0612G000GA3KM0	6020757
	Head A: female connector, M26, 12-pin, angled Cable: unshielded 12 crimping contacts enclosed		DOS-0612W000GA3KM0	6020758
	Head A: male connector, M26, 12-pin, straight Cable: unshielded 12 crimping contacts enclosed		STE-0612G000GA3KM0	6021191
	Head A: male connector, M26, 12-pin, angled Cable: unshielded 12 crimping contacts enclosed		STE-0612W000GA3KM0	6021192
<b>Alignment aids</b>				
	Laser alignment aid for various sensors, laser class 2 (IEC 60825). Do not look into the beam!		AR60	1015741
	Adapter AR60 for housing cross-section 48 mm x 40 mm		AR60 adapter, 48x40	4032461
	Adapter AR60 for housing cross-section 48 mm x 40 mm in PU3H device column		AR60 adapter, 48x40, PU3H	4056731
<b>Optics cloths</b>				
	Cloth for cleaning optical surfaces		Lens cloth	4003353
<b>Cleaning agent</b>				
	Plastic cleaner and care product, anti-static, 0.5 liter		Plastic cleaner	5600006
<b>Switching amplifiers</b>				
		UE402	UE402	1023577

## SICK AT A GLANCE

SICK is one of the leading manufacturers of intelligent sensors and sensor solutions for industrial applications. A unique range of products and services creates the perfect basis for controlling processes securely and efficiently, protecting individuals from accidents and preventing damage to the environment.

We have extensive experience in a wide range of industries and understand their processes and requirements. With intelligent sensors, we can deliver exactly what our customers need. In application centers in Europe, Asia and North America, system solutions are tested and optimized in accordance with customer specifications. All this makes us a reliable supplier and development partner.

Comprehensive services complete our offering: SICK LifeTime Services provide support throughout the machine life cycle and ensure safety and productivity.

For us, that is “Sensor Intelligence.”

## WORLDWIDE PRESENCE:

Contacts and other locations –[www.sick.com](http://www.sick.com)