

DF1212

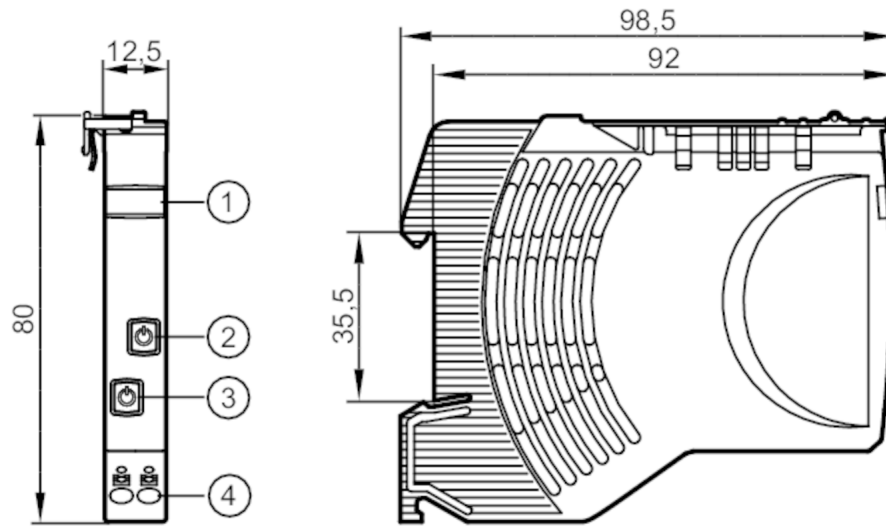

Electronic circuit breaker

Fuse/Standard/24VDC/2x2A



- 1 panel for labelling
- 2 pushbutton on / off / reset status LED 2
- 3 pushbutton on / off / reset status LED 1
- 4 push-in terminals Outputs 1/2



Electrical data		
Operating voltage	[V]	to SELV/PELV; "supply class 2" to cURus
Nominal voltage DC	[V]	24
Input voltage DC	[V]	19.2...30
Protection class		III
Mains buffering time (nominal voltage 24 V DC)	[ms]	10
Closed-circuit current	[mA]	8
Number of channels		2
Nominal current	[A]	2
Nominal current (Fail Safe Element)	[A]	2
Outputs		
Load capacitance, total	[mF]	10
Operating conditions		
Ambient temperature	[°C]	-25...60
Storage temperature	[°C]	-40...70
Protection		IP 20; (on the front)
Degree of soiling		2
Tests / approvals		
EMC	EN 61000-6-3	radiation of interference
	EN 61000-6-2	immunity

DF1212



Electronic circuit breaker

Fuse/Standard/24VDC/2x2A

Mechanical data		
Weight	[g]	70
Dimensions	[mm]	80 x 12.5 x 98.5
Displays / operating elements		
Display	status	2 x LED, red / green / orange
Operating elements	2 x	pushbutton
Electrical connection		
push-in terminals:		
contact lever/strip:		
Connection		

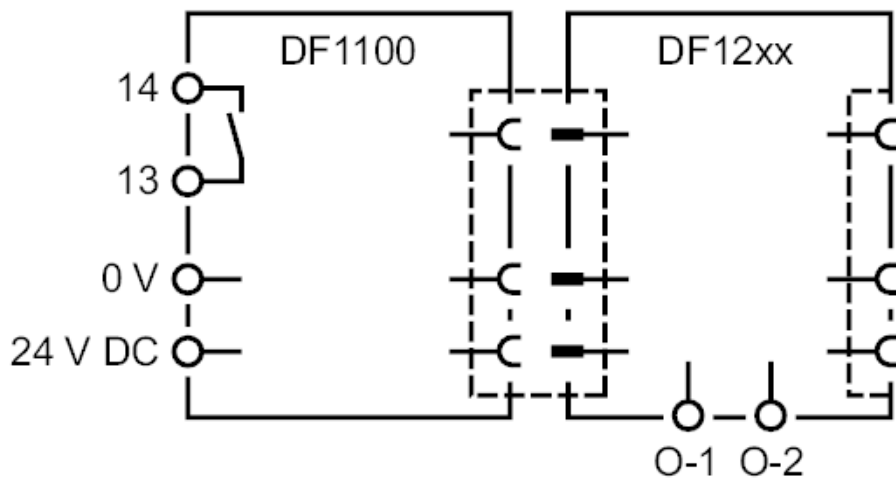

Diagrams and graphs	
output characteristics	
	time-current characteristics