

E12592

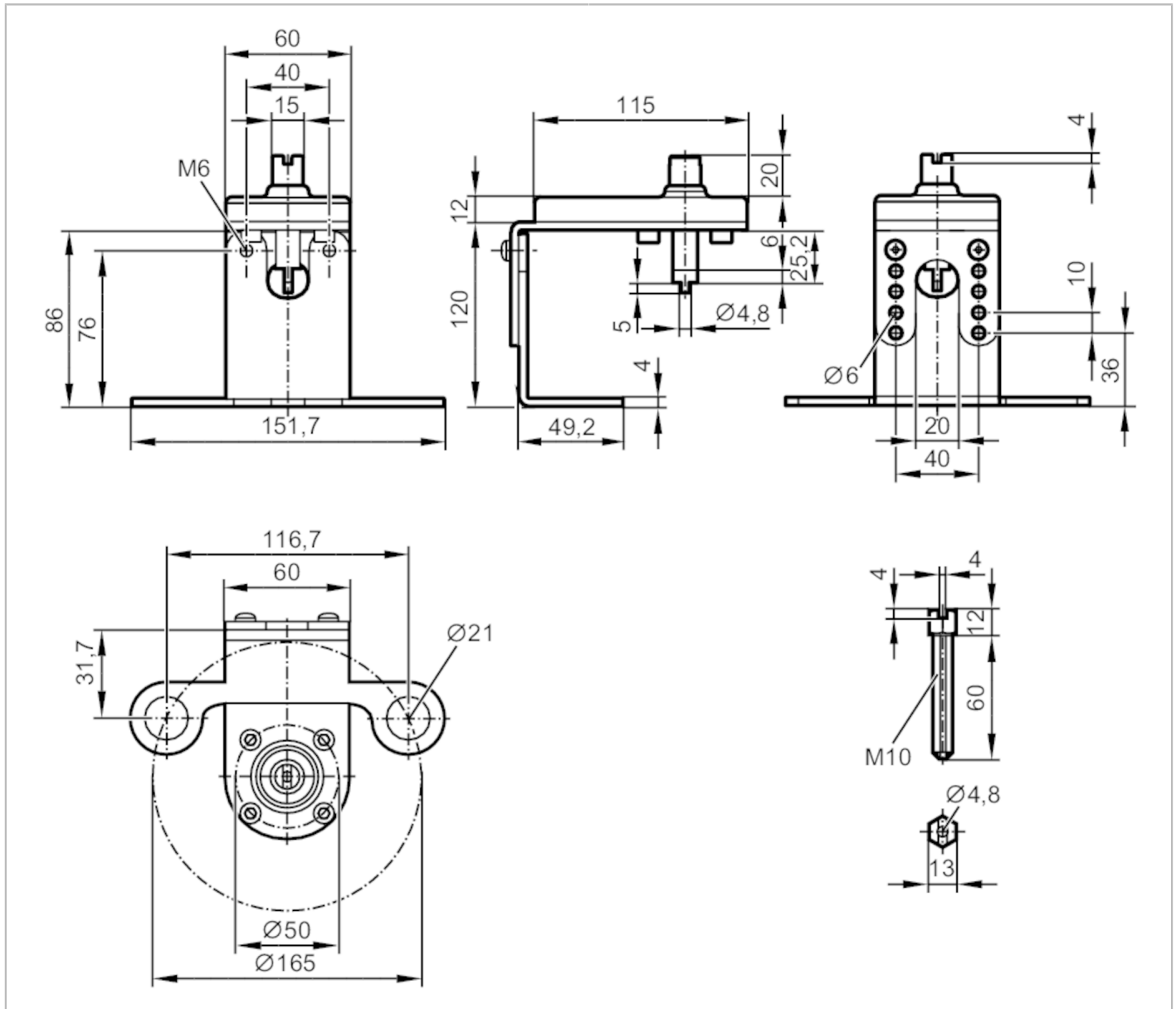

Mounting set for manual valves and ball valves

MOUNTING KIT FOR MANUAL VALVES F16/M10



Application	
Design	for types IND, INE
Operating conditions	
Ambient temperature	[°C] -30...80
Mechanical data	
Weight	[g] 716
Top flange diameter	[mm] 165
ISO top flange type	F16
Shaft extension	M10
Materials	Mounting plate: plastics; metal parts: stainless steel (1.4301 / 304)
Remarks	
Pack quantity	1 pcs.