

E33712

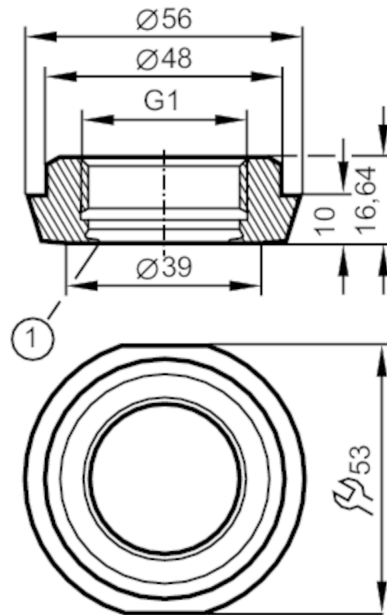

Process adapter hygienic pipe fitting

ADAPT IFM-DIN11851 DN40/1.5"



1 sealing edge

EC 1935/2004 FCM 

Application	
Pressure rating	[bar] 40
Tests / approvals	
Pressure Equipment Directive	A possible classification to PED depends on the application and has to be carried out by the user / operator.
Safety instructions	The compatibility between medium and product material has to be checked in all applications.
Mechanical data	
Weight	[g] 199
Materials (wetted parts)	stainless steel (1.4435 / 316L) ; surface characteristics : Ra<0,4 / Rz 4
Sensor connection	G 1 Aseptoflex Vario
Process connection	hygienic pipe fitting DN40 (1,5") DIN 11851
Sealing	metal to metal
Hygienic equipment class to DIN 11866	H4
Remarks	
Pack quantity	1 pcs.