

E37613

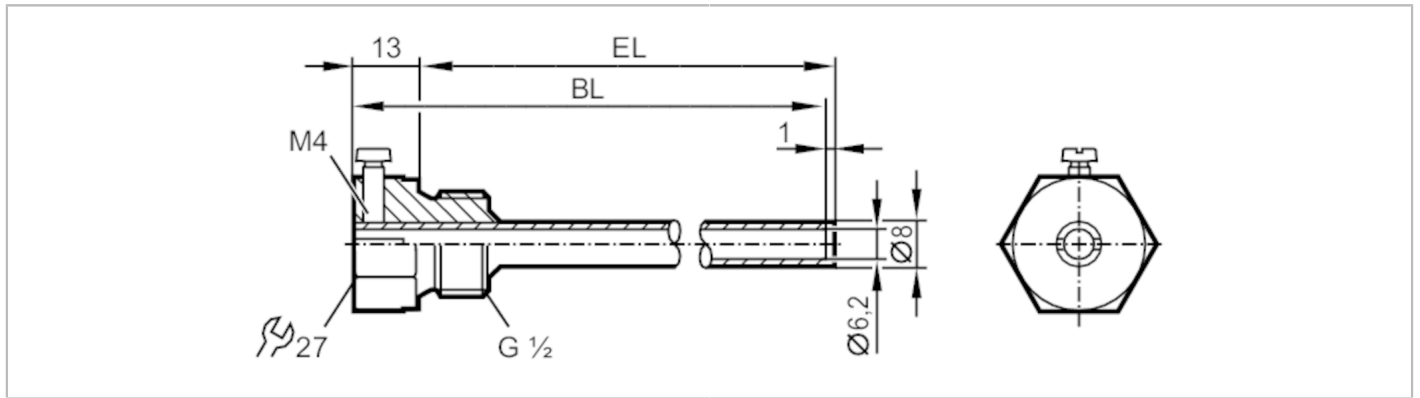

Thermowell for temperature sensors

THERMOWELL, D6/ 6mm/L=100



Application

Design	for temperature sensors EL = 100 mm
Pressure rating [bar]	100
Note on pressure rating	< 250 °C

Mechanical data

Weight [g]	107
Materials	stainless steel (1.4571/316Ti)
Sensor connection	Ø 6 mm
Process connection	G 1/2
Installation length EL [mm]	83
Bore length BL [mm]	95

Remarks

Pack quantity	1 pcs.
---------------	--------