

# E37850

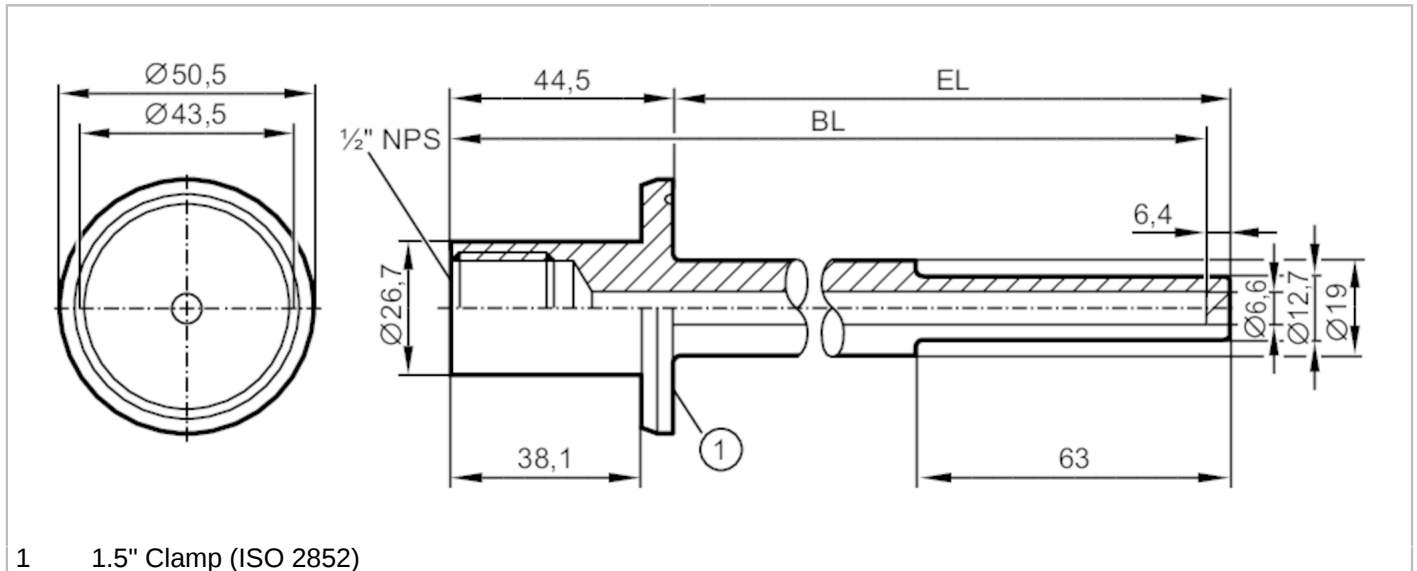

## Thermowell for temperature sensors

THERMOWELL, D6/1,5"CLAMP/L=300



EC 1935/2004 EHEDG Certified



Application	
Design	for temperature sensors EL = 350 mm
Pressure rating [bar]	25
Mechanical data	
Weight [g]	653
Materials	stainless steel (1.4404 / 316L)
Sensor connection	1/2" NPS Ø 6 mm suitable for G1/2 and 1/2" NPT
Process connection	Clamp DN25...DN40 (1...1,5") DIN 32676 (ISO 2852)
Surface characteristics Ra/Rz of the wetted parts	≤ 0.6 / -
Installation length EL [mm]	267
Bore length BL [mm]	304.8
Remarks	
Pack quantity	1 pcs.