

# E43205

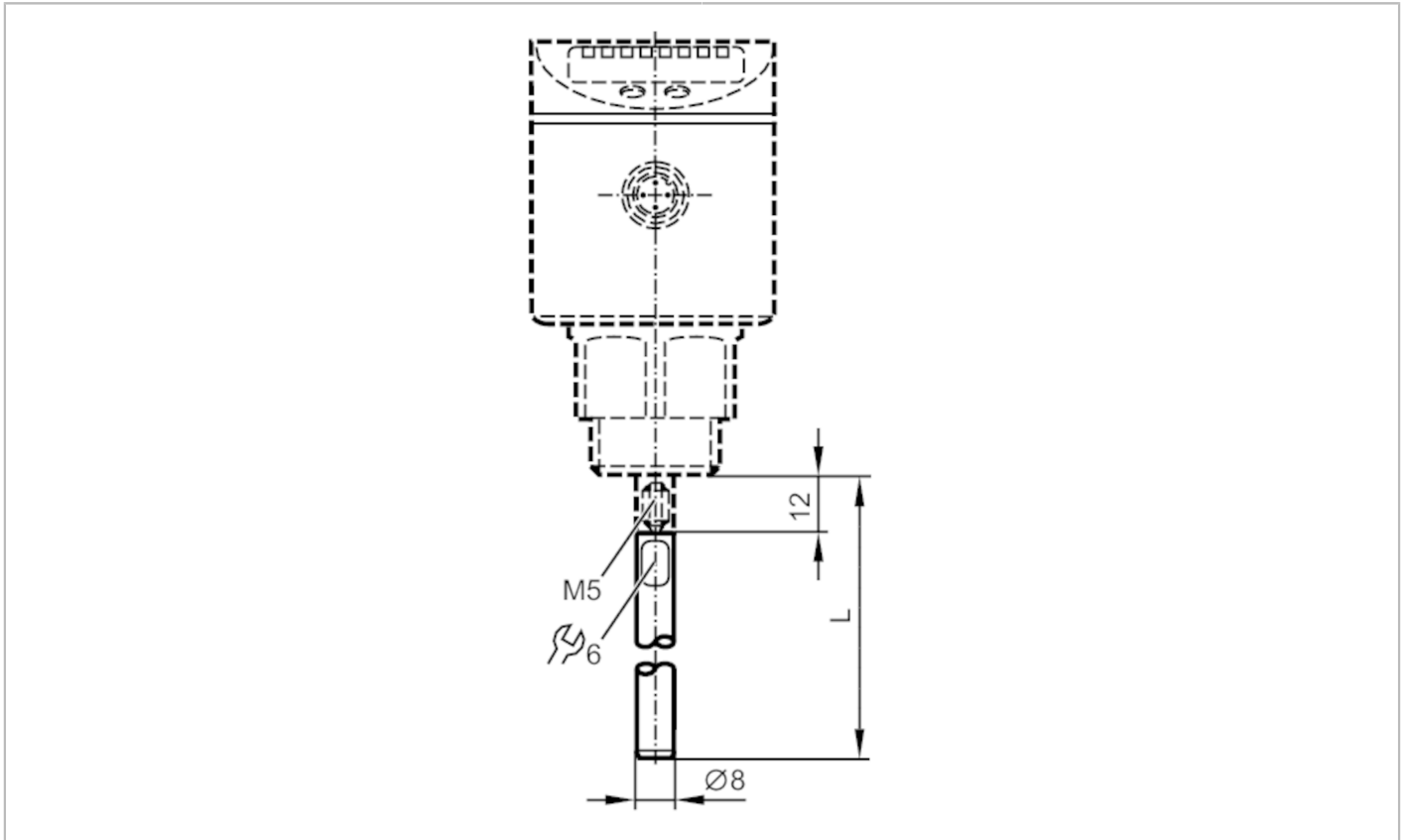

## Probe for level sensors

LR PROBE L700



### Application

Design for level sensors LR

### Measuring/setting range

Probe length L [mm] 700

### Mechanical data

Weight [g] 300

Materials stainless steel (1.4404 / 316L)

Tightening torque [Nm] 4

### Remarks

Pack quantity 1 pcs.