

# E43208

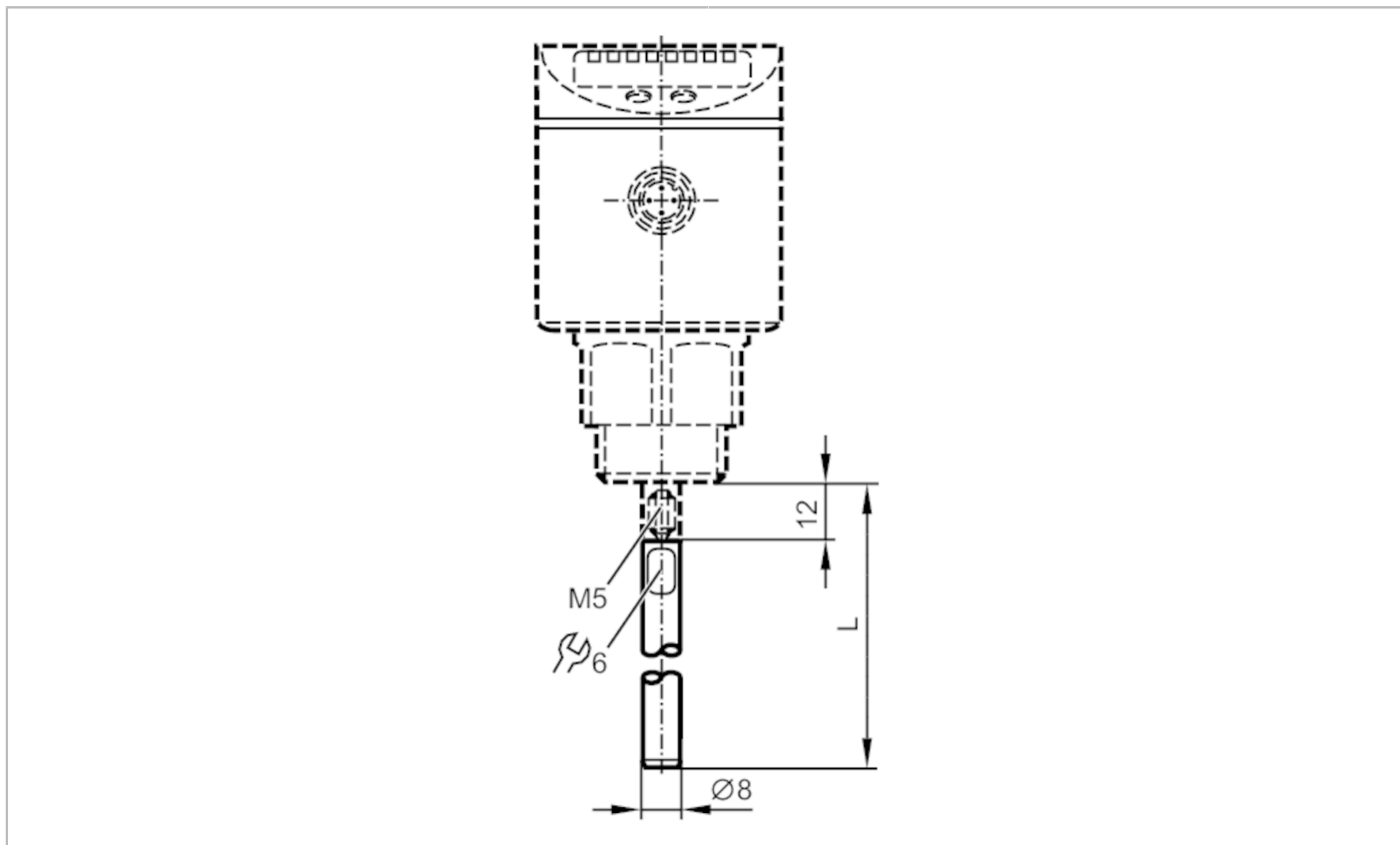

## Probe for level sensors

LR PROBE L1200



### Application

Design for level sensors LR

### Measuring/setting range

Probe length L [mm] 1200

### Mechanical data

Weight [g] 515

Materials stainless steel (1.4404 / 316L)

Tightening torque [Nm] 4

### Remarks

Pack quantity 1 pcs.