

E60098

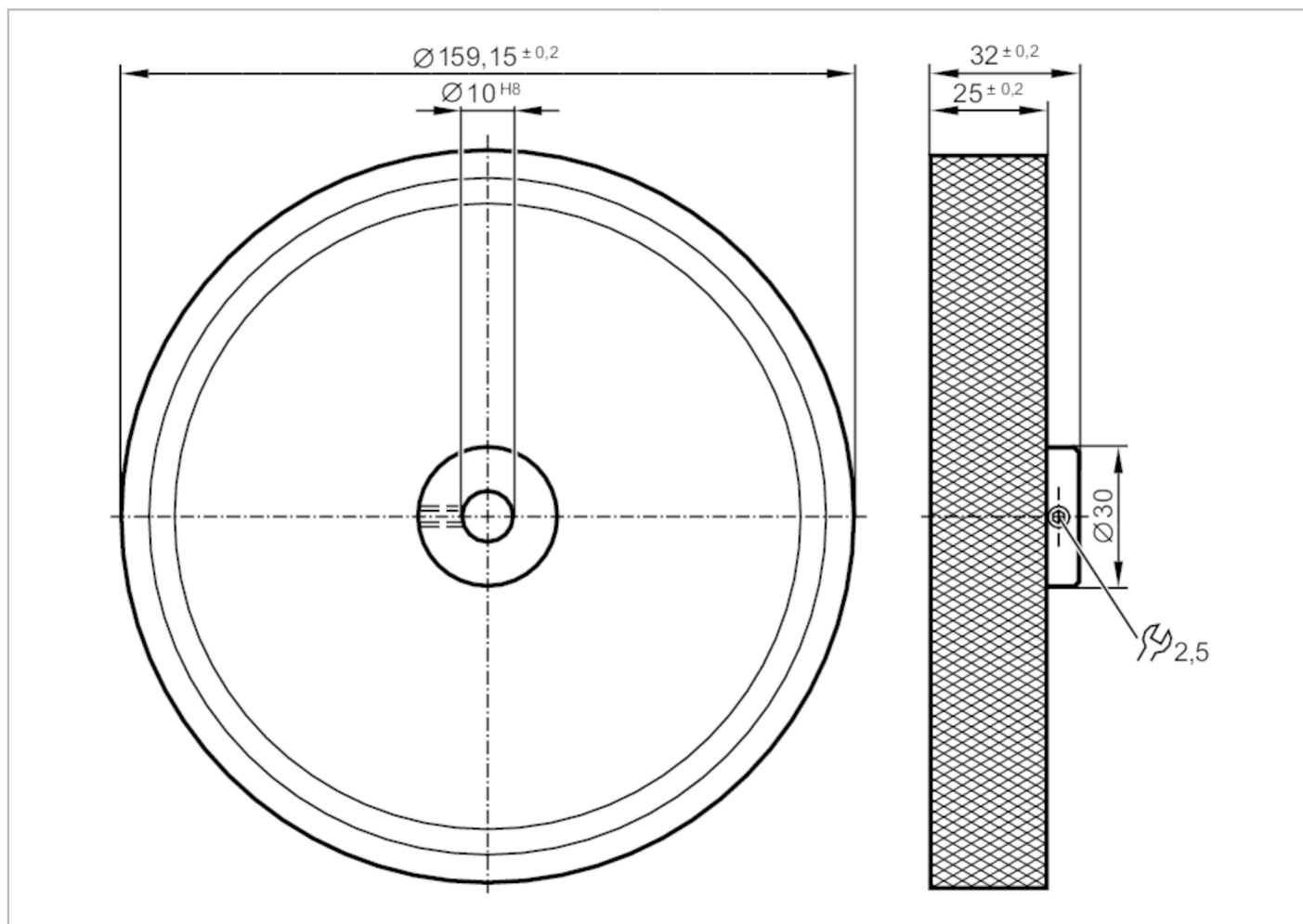

Measuring wheel

MEASURING WHEEL U:500 N:10



Application	
Design	cross-knurl
Operating conditions	
Ambient temperature	[°C] -30...80
Mechanical data	
Weight	[g] 551.5
Inside diameter	[mm] 10
External diameter	[mm] 159.15
Materials	wheel: aluminium; surface characteristics: aluminium
Circumference	[mm] 500
Remarks	
Pack quantity	1 pcs.