

E60112

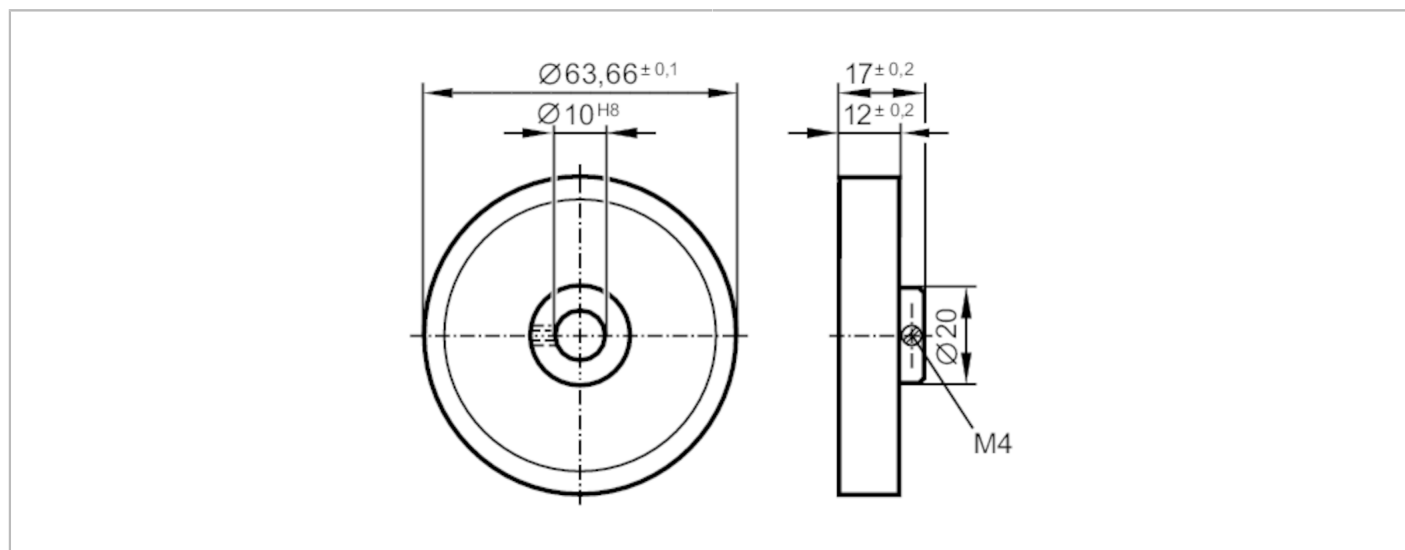

Measuring wheel

MEASURING WHEEL U:200 N:10



Application	
Design	smooth plastic
Operating conditions	
Ambient temperature	[°C] -30...80
Mechanical data	
Weight	[g] 61.5
Inside diameter	[mm] 10
External diameter	[mm] 63.66
Materials	wheel: aluminium; surface characteristics: PU
Tightening torque	[Nm] 1.5; (Mounting screw)
Surface hardness	90 Shore A
Circumference	[mm] 200
Remarks	
Pack quantity	1 pcs.