

EVC039



Connection cable

VDOAH043MSS0005H04STAH040MSS

Please see the technical note under "Downloads"

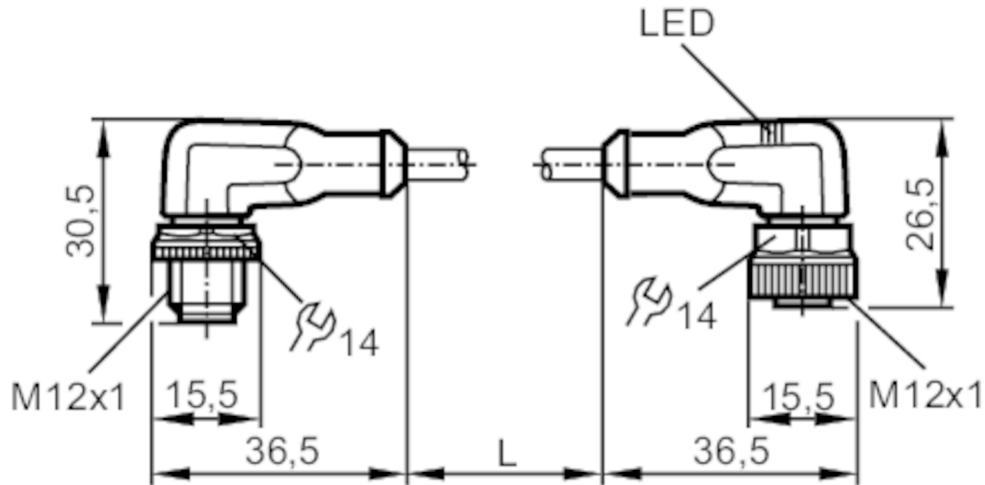

Application	
Special feature	Free from silicone; Halogen-free; Gold-plated contacts; Drag chain suitability
Free from silicone	yes
Electrical data	
Operating voltage [V]	10...36 DC
Protection class	II
Max. current load total [A]	4
Outputs	
Electrical design	PNP
Operating conditions	
Ambient temperature [°C]	-25...90
Note on ambient temperature	cULus: ...75
Ambient temperature (moving) [°C]	-25...90
Note on ambient temperature (moving)	cULus: ...75
Protection	IP 65; IP 67; IP 68; IP 69K
Tests / approvals	
MTTF [years]	2027

EVC039



Connection cable

VDOAH043MSS0005H04STAH040MSS

Mechanical data		
Weight [g]	192.5	
Dimensions [mm]	30.5 x 15.5 x 36.5	
Moulded-body material	TPU / TPU	
Material nut	brass, nickel-plated / brass, nickel-plated	
Sealing material	FKM	
Drag chain suitability	yes	
Drag chain suitability	bending radius for flexible use	min. 10 x cable diameter
	travel speed	max. 3.3 m/s for a horizontal travel length of 5 m and max. acceleration of 5 m/s ²
	bending cycles	> 5 Mio.
	torsional strain	± 180 °/m

Displays / operating elements		
Display	switching status	2 x LED, yellow
	operation	1 x LED, green

Remarks	
Notes	Please see the technical note under "Downloads"
Pack quantity	1 pcs.

Electrical connection - plug

Connector: 1 x M12, angled; Moulded body: TPU, orange; Locking: brass, nickel-plated; Contacts: gold-plated; Tightening torque: 0.6...1.5 Nm



Electrical connection

Cable: 5 m, PUR, Halogen-free, black, Ø 4.3 mm; 4 x 0.34 mm² (42 x Ø 0.1 mm)

Connection

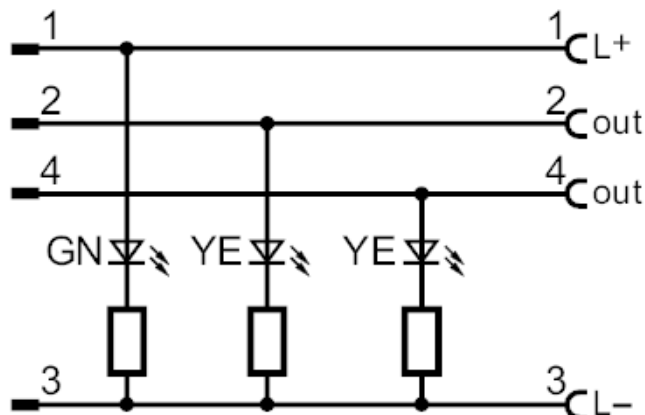

EVC039



Connection cable

VDOAH043MSS0005H04STAH040MSS

Electrical connection - socket

Connector: 1 x M12, angled; Moulded body: TPU, black transparent; Locking: brass, nickel-plated; Sealing: FKM; Contacts: gold-plated; Tightening torque: 0.6...1.5 Nm

