

EVC14A

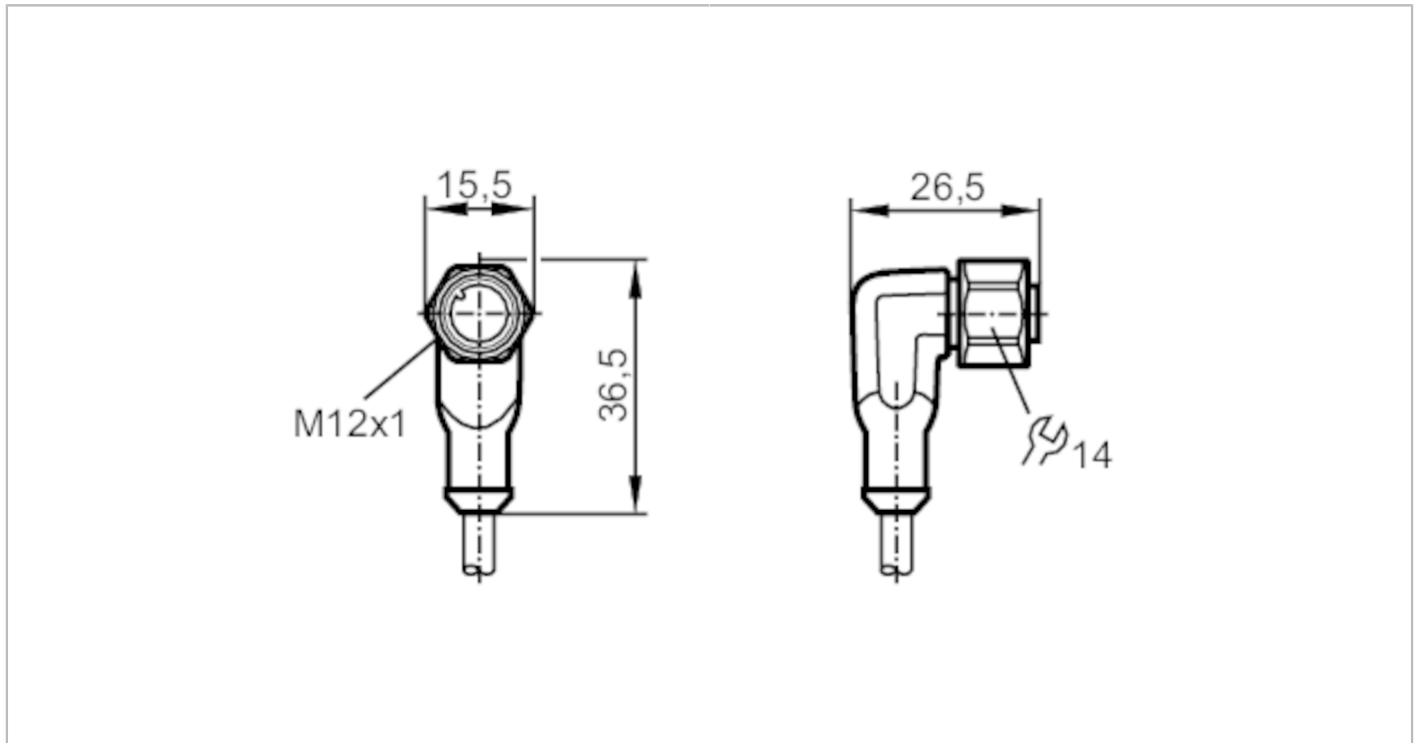

Connecting cable with socket

ADOAH040VAT0025H04/3G/2D



Application	
Special feature	Halogen-free; Gold-plated contacts
Compatible with paint	yes
Electrical data	
Operating voltage [V]	< 60 AC/DC
Protection class	II
Max. current load total [A]	2
Operating conditions	
Ambient temperature [°C]	-20...60
Protection	IP 67; (when used outside the hazardous area: IP 68 / IP 69K)
Tests / approvals	
Approval	BVS 08 ATEX E 109 U; IECEx BVS 08.0041 U
ATEX marking	II 3G Ex nA IIC Gc
	II 2D Ex tb IIIC Db IP65/IP67
Mechanical data	
Weight [g]	833
Dimensions [mm]	26.5 x 15.5 x 36.5
Materials	housing: TPU orange; Sealing: FKM
Material nut	stainless steel (1.4404 / 316L)
Remarks	
Pack quantity	1 pcs.

EVC14A



Connecting cable with socket

ADOAH040VAT0025H04/3G/2D

Electrical connection

Cable: 25 m, PUR, Halogen-free, black, Ø 4.9 mm; 4 x 0.34 mm² (42 x Ø 0.1 mm)

Electrical connection - socket

Connector: 1 x M12, angled; Locking: stainless steel (1.4404 / 316L); Contacts: gold-plated; Tightening torque: 1.2...1.5 Nm

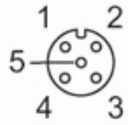

Connection

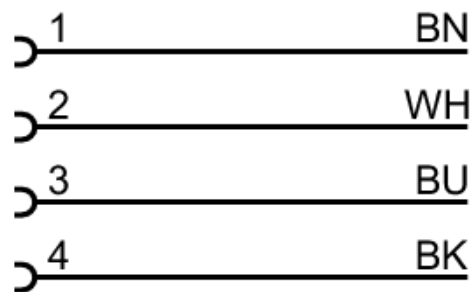

Core colours :

BK = black
BN = brown
BU = blue
WH = white