

EVF054

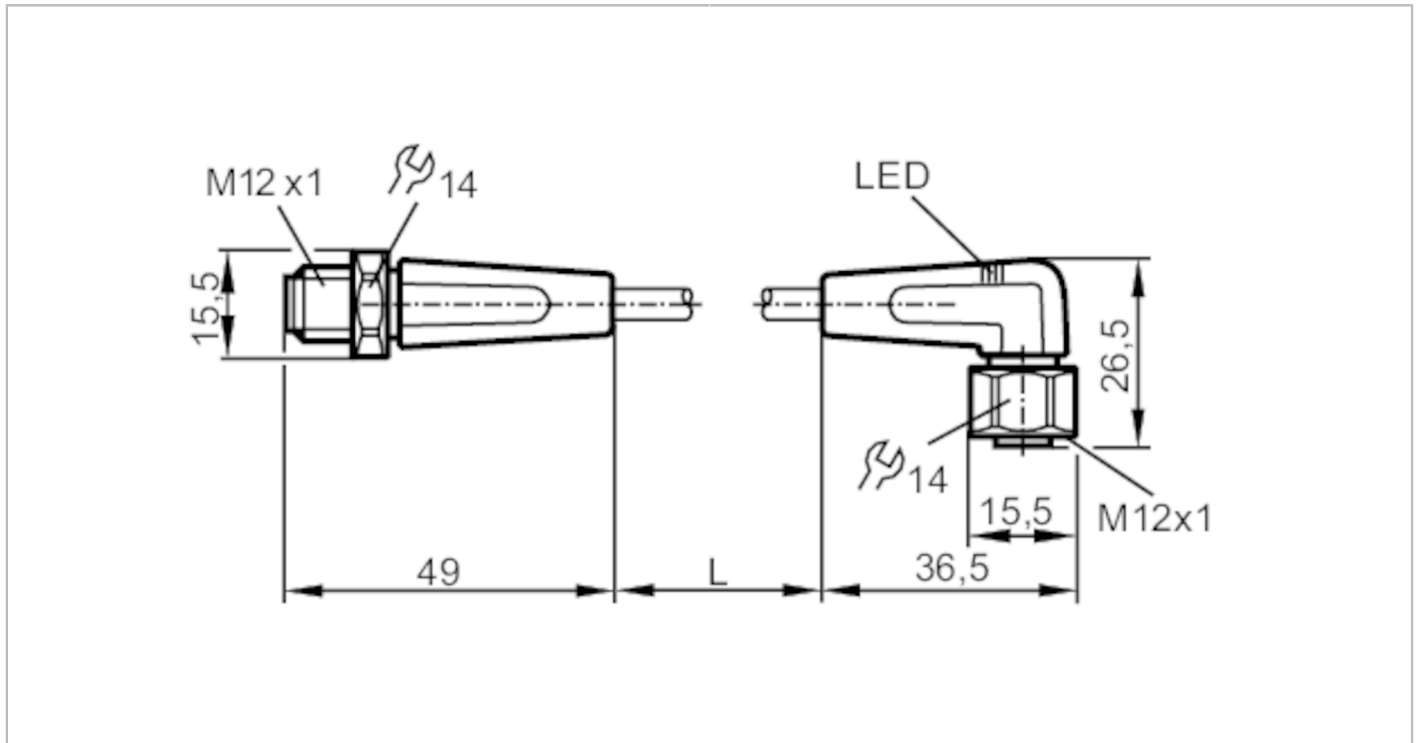

Connection cable

VDOAH043VAS0001P04STGH040VAS



Application	
Special feature	Free from silicone; Halogen-free; Gold-plated contacts; Drag chain suitability
Application	hygienic and wet areas in the food industry
Free from silicone	yes
Electrical data	
Operating voltage [V]	10...36 DC
Protection class	II
Max. current load total [A]	4
Outputs	
Electrical design	PNP
Operating conditions	
Ambient temperature [°C]	-25...100
Note on ambient temperature	cULus: ...65 °C
Ambient temperature (moving) [°C]	0...100
Note on ambient temperature (moving)	cULus: ...65 °C
Protection	IP 65; IP 67; IP 68; IP 69K

EVF054



Connection cable

VDOAH043VAS0001P04STGH040VAS

Mechanical data		
Weight [g]	58.5	
Dimensions [mm]	15.5 x 15.5 x 49	
Moulded-body material	PP, Halogen-free / PP, Halogen-free	
Material nut	stainless steel (1.4404 / 316L) / stainless steel (1.4404 / 316L)	
Sealing material	EPDM	
Drag chain suitability	yes	
Drag chain suitability	bending radius for flexible use	min. 10 x cable diameter
	travel speed	max. 3.3 m/s for a horizontal travel length of 5 m and max. acceleration of 5 m/s ²
	bending cycles	> 1 Mio.
	torsional strain	± 180 °/m

Displays / operating elements		
Display	switching status	2 x LED, yellow
	operation	1 x LED, green

Remarks	
Pack quantity	1 pcs.

Electrical connection - plug

Connector: 1 x M12, straight; Moulded body: PP, Halogen-free, grey; Locking: stainless steel (1.4404 / 316L); Contacts: gold-plated; Tightening torque: 0.6...1.2 Nm



Electrical connection

Cable: 1 m, MPPE, Halogen-free, grey, Ø 4.9 mm; 4 x 0.34 mm² (42 x Ø 0.1 mm)

Connection

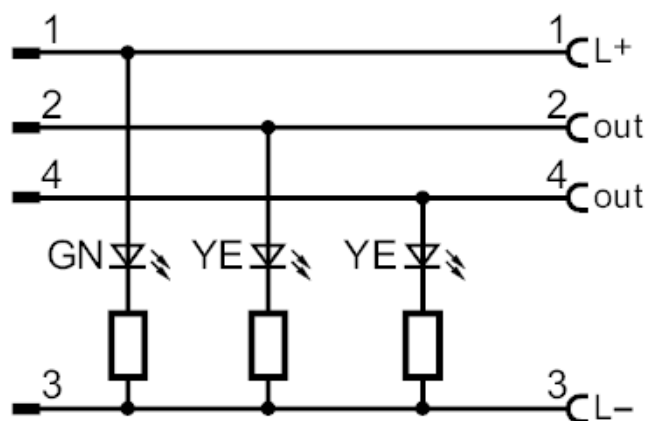

EVF054



Connection cable

VDOAH043VAS0001P04STGH040VAS

Electrical connection - socket

Connector: 1 x M12, angled; Moulded body: PP, Halogen-free, black transparent; Locking: stainless steel (1.4404 / 316L); Sealing: EPDM; Contacts: gold-plated; Tightening torque: 0.6...1.5 Nm

