



Installation instructions
Welding adapter
for units with Aseptoflex Vario adaptation

UK

706016 / 04 10 / 2020

Contents

1 Preliminary note.....	2
1.1 Symbols used.....	2
2 Safety instructions	3
3 Intended use.....	3
3.1 Basic notes	4
4 Installation.....	5
4.1 Welding operation with welding aid	5
4.2 Post-processing.....	8
5 Mount sensor	9
6 Set-up	9

1 Preliminary note

1.1 Symbols used

- ▶ Instruction
- > Reaction, result
- [...] Designation of keys, buttons or indications
- Cross-reference



Important note

Non-compliance may result in malfunction or interference.



Information

Supplementary note



CAUTION

Warning of personal injury.

> Slight reversible injuries may result.

2 Safety instructions

- The product described is a subcomponent for integration into a system.
 - The system architect is responsible for the safety of the system.
 - The system creator undertakes to perform a risk assessment and to create documentation in accordance with legal and normative requirements to be provided to the operator and user of the system. This documentation must contain all necessary information and safety instructions for the operator, the user and, if applicable, for any service personnel authorised by the architect of the system.
- Read this document before setting up the product and keep it during the entire service life.
- The product must be suitable for the corresponding applications and environmental conditions without any restrictions.
- Only use the product for its intended purpose (→ Intended use).
- Only use the product for permissible media.
- If the operating instructions or the technical data are not adhered to, personal injury and/or damage to property may occur.
- The manufacturer assumes no liability or warranty for any consequences caused by tampering with the product or incorrect use by the operator.
- Installation, set-up, operation and maintenance of the product must be carried out by personnel qualified and authorised for the respective activity.
- Protect the product against damage.

UK

3 Intended use

The welding adapter allows the installation of sensors in tanks or piping systems.

3.1 Basic notes



When used in hygienic areas to EHEDG and 3A:

- Adhere to the applicable EHEDG and 3A directives.
- Assure EHEDG-compliant or 3A-compliant integration of the adapter in the plant (observe the notes in the operating instructions of the sensor to be used).

3A conformity is only ensured in connection with 3A approved sensors.



If the tank or pipe system is treated after the adapter has been welded in (e.g. grinding, pickling, sand-blasting, glass bead blasting or applying procedures such as powder coating, painting etc.):

- Make sure that the interior and the sealing edge of the adapter are not post-treated or damaged.
Appropriate measure: Using the welding aid (→ 4.1).



- The welding operation must be carried out by authorised personnel.
- The welding operation must be carried out carefully and according to state-of-the-art technology.
- During welding and the following cooling phase the sensor must not be in place.
- The surfaces must be free from any contamination.
- Welding materials must be suitable for the adapter and wall material.



- ▶ The requirements in the specifications, of common practice, in regulations, norms, of intended use and the application must be applied.
- > They determine the welding procedure, the welding material, the connection category and connection type, including chamfer, welding penetration depth and demands on the surface.

4 Installation



CAUTION!

During the welding operation, the adapter and the welding aid can increase in temperature to over 65 °C (149 °F).

> Risk of burns.

▶ Let the adapter and the welding aid cool down.

4.1 Welding operation with welding aid

UK



The basic notes and guidelines must be adhered to (→ 3.1).



- The welding method must be suitable for the welding task and the power of the welding equipment must be adapted to the material thickness.
- The adapter must not warp.
- During welding, avoid overheating of the adapter and observe sufficient cooling phases.
- The sealing edge of the adapter must not be damaged by weld spatter or similar. Ensure sufficient protection of the sealing edge before starting the welding process (→ 3.1).

▶ Bore a hole in the pipe or tank wall with the outside diameter of the adapter.



▶ Basic notes (→ 3.1).

▶ Insert welding aid E30452 (for heat conduction and protection of the sealing edge) → Instructions E30452.



Use the counterplate (A) only if it can be removed after the welding process.

Welding aid on tanks:

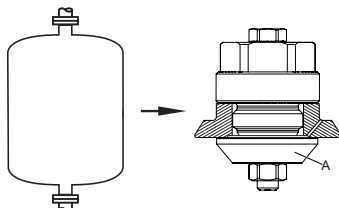

Welding aid on pipes:

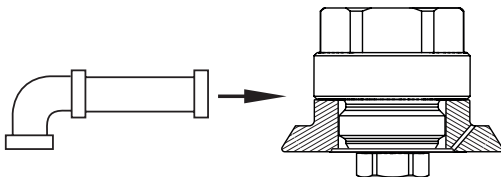

- ▶ Adapter alignment: Turn the marking (1) (marking may vary) to the position provided for the display of the screwed sensor.

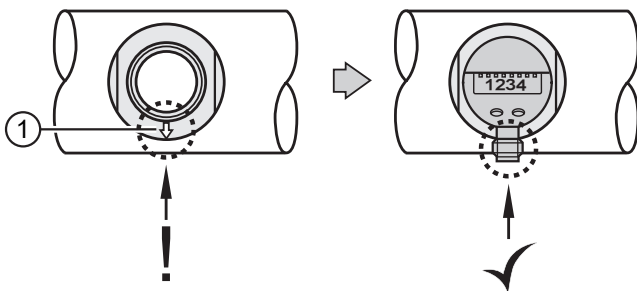

Adapter with leakage ports according to EHEDG and 3A:

- ▶ For reliable draining: Align the adapter with only one leakage port so that the leakage port is located at the lowest possible point.

- ▶ Fix the adapter in several spots with a sufficient adhesive force. Apply the fixing points at equal distance opposite each other.

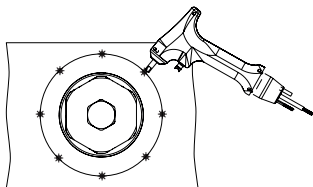

UK

- ▶ Apply the welding seams between the fixing points opposite each other.
- ▶ Ensure sufficient intervals between the individual sections to avoid glowing through or warping of the adapter due to overheating.

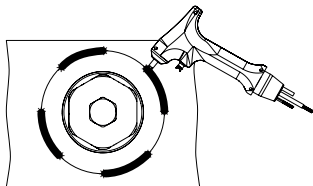

- ▶ Apply/Place the weld seam on the inside and/or outside of the wall.



- ▶ Basic notes (→ 3.1).

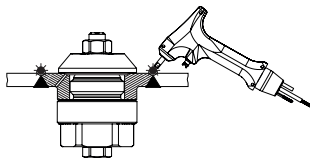

- ▶ Let the adapter and the welding aid cool down.
- ▶ Remove the welding aid.
- ▶ Remove deposits from the adapter thread.
- ▶ Screw in the sensor by hand in order to check for dimensional accuracy and functionality of the thread. If the tightening torque is too high, do not use any tool, but check the thread and replace the adapter, if necessary.

4.2 Post-processing



Prevent any damage to the sealing edge on the adapter if subsequent surface post-processing (e.g. grinding / polishing of the weld seam) is necessary.

- ▶ Insert welding aid E30452 or equivalent device to protect the sealing edge
→ Instructions E30452.
- ▶ Carefully remove the material around the adapter in case of possible post-processing (e.g. grinding / polishing).
- ▶ Leave the sealing edge for the sensor sealing unaffected.

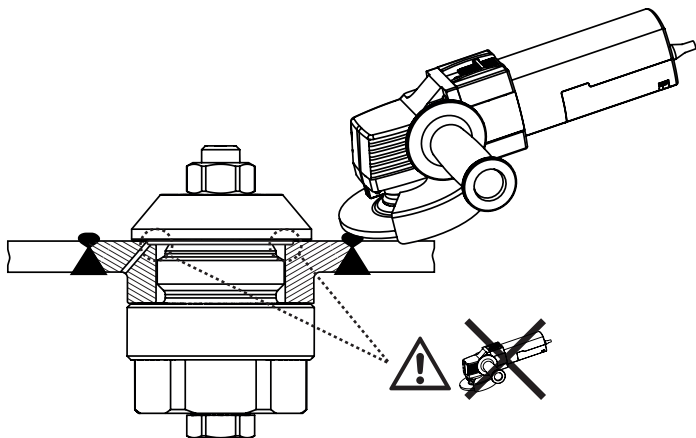

- ▶ Let the adapter and the welding aid cool down.
- ▶ Remove the welding aid.
- ▶ Remove deposits from the adapter thread.
- ▶ Screw in the sensor by hand in order to check for dimensional accuracy and functionality of the thread. If the tightening torque is too high, do not use any tool, but check the thread and replace the adapter, if necessary.

5 Mount sensor

! A lubricating paste is required to install the sensor. It must be suitable and approved for the given application and compatible with the elastomers used (e.g. seal).

i The adapter is supplied with an EPDM O-ring. More sealing rings are available as accessories: FKM O-ring, order no. E30123

- ▶ Remove protective packaging only just before mounting.
- ▶ Ensure cleanliness of the sealing areas.

- ▶ Place the sealing ring (B) in the groove (C) of the sensor.
- ▶ Use lubricating paste (A) sparingly and apply to threaded parts.

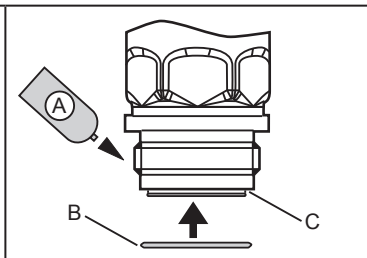

- ▶ Tighten the sensor using a spanner until you can feel the end stop (this corresponds to a maximum tightening torque of approx. 35 Nm).

! Too much torque may impair the seal.

! If the sealing area is damaged: replace the adapter.

6 Set-up

- ▶ Before set-up check the tank or pipe for ingress resistance.
- ▶ Perform a pressure test with screwed-in dummy plug or sensor.
- ▶ Set-up of the sensor: → Operating instructions of the sensor.

More information at www.ifm.com