



PNOZ mmc12p

PILZ
THE SPIRIT OF SAFETY

- ▶ Configurable compact control systems PNOZmulti Mini

This document is a translation of the original document.

All rights to this documentation are reserved by Pilz GmbH & Co. KG. Copies may be made for internal purposes. Suggestions and comments for improving this documentation will be gratefully received.

Source code from third-party manufacturers or open source software has been used for some components. The relevant licence information is available on the Internet on the Pilz homepage.

Pilz®, PIT®, PMI®, PNOZ®, Primo®, PSEN®, PSS®, PVIS®, SafetyBUS p®, SafetyEYE®, SafetyNET p®, the spirit of safety® are registered and protected trademarks of Pilz GmbH & Co. KG in some countries.



SD means Secure Digital

Section 1	Introduction	4
	1.1 Validity of documentation	4
	1.2 Using the documentation	4
	1.3 Definition of symbols	4
Section 2	Overview	6
	2.1 Scope of supply	6
	2.2 Unit features	6
	2.3 Front view	7
Section 3	Safety	8
	3.1 Intended use	8
	3.2 System requirements	8
	3.3 Safety regulations	9
	3.3.1 Use of qualified personnel	9
	3.3.2 Warranty and liability	9
	3.3.3 Disposal	9
	3.3.4 For your safety	9
Section 4	Function description	10
	4.1 Functions	10
	4.2 Input and output data	10
	4.3 Block diagram	11
Section 5	Installation	12
	5.1 General installation guidelines	12
	5.2 Dimensions in mm	12
	5.3 Connect the base unit and expansion modules	13
Section 6	Commissioning	14
	6.1 General wiring guidelines	14
	6.2 Connecting the supply voltage	15
	6.3 Interface assignment	15
	6.4 Download modified project to the PNOZmulti system	15
	6.5 Connection example	16
Section 7	Operation	17
	7.1 LED indicators	17
Section 8	Technical Details	19
Section 9	Order reference	22
	9.1 Product	22
	9.2 Accessories	22

1 Introduction

1.1 Validity of documentation

This documentation is valid for the product PNOZ mmc12p. It is valid until new documentation is published.

This operating manual explains the function and operation, describes the installation and provides guidelines on how to connect the product.

1.2 Using the documentation

This document is intended for instruction. Only install and commission the product if you have read and understood this document. The document should be retained for future reference.

1.3 Definition of symbols

Information that is particularly important is identified as follows:



DANGER!

This warning must be heeded! It warns of a hazardous situation that poses an immediate threat of serious injury and death and indicates preventive measures that can be taken.



WARNING!

This warning must be heeded! It warns of a hazardous situation that could lead to serious injury and death and indicates preventive measures that can be taken.



CAUTION!

This refers to a hazard that can lead to a less serious or minor injury plus material damage, and also provides information on preventive measures that can be taken.



NOTICE

This describes a situation in which the product or devices could be damaged and also provides information on preventive measures that can be taken. It also highlights areas within the text that are of particular importance.

**INFORMATION**

This gives advice on applications and provides information on special features.

2 Overview

2.1 Scope of supply

- ▶ Expansion module PNOZ mmc12p
- ▶ Jumper

2.2 Unit features

Using the product PNOZ mmc12p:

Expansion module for connection to a base unit from the configurable control system PNOZmulti Mini .

The product has the following features:

- ▶ Can be configured in the PNOZmulti Configurator
- ▶ Connection for Ethernet POWERLINK (Ethernet POWERLINK V 2 protocol)
- ▶ Station addresses from 1 ... 239, selected via rotary switch
- ▶ The minimum cycle time for an application of 20 Byte Output and 20 Byte Input is 250µs. The minimum cycle time is 450 µs at the maximum PDO size of 254 Byte Input and 20 Byte Output (the inputs and outputs in this case are viewed from the Managing Node).
- ▶ 24 virtual inputs and outputs on the control system PNOZmulti can be defined in the PNOZmulti Configurator for communication with the fieldbus Ethernet POWERLINK . The number of inputs and outputs can be extended to 128. Please note that when the extended inputs and outputs 24 - 127 are used they have different properties (see document entitled "Communication Interfaces").
- ▶ Max. 1 PNOZ mmc12p can be connected to the base unit
- ▶ For details of the PNOZmulti Mini base units that can be connected, please refer to the document "PNOZmulti System Expansion".

2.3 Front view

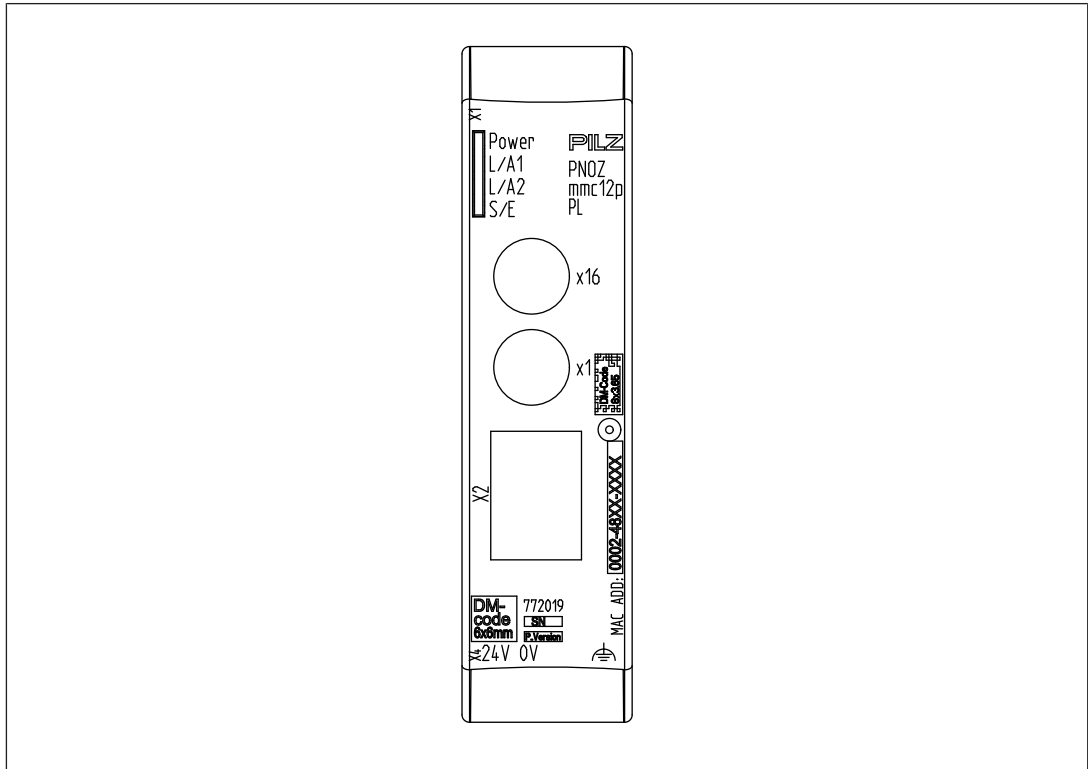

Legend:

- ▶ X1, X2: Ethernet POWERLINK interfaces
- ▶ 0 V, 24 V: Supply connections
- ▶ : Functional earth
- ▶ LED:
 - Power
 - L/A1
 - L/A2
 - S/E (Status/Error)

3 Safety

3.1 Intended use

The fieldbus module PNOZ mmc12p is an expansion module of the configurable control system PNOZmulti Mini. It is used for communication between the configurable control system PNOZmulti Mini and Ethernet POWERLINK. Ethernet POWERLINK is designed for fast data exchange at field level. The expansion module PNOZ mmc12p is a passive subscriber (Controlled Node) of the Ethernet POWERLINK. The basic communication functions with Ethernet POWERLINK conform to the System Description published by the POWERLINK User Group (EPSG). The central controller (Managing Node) reads input information from the slaves and writes output information to the slaves as part of each cycle. As well as the cyclical transfer of usable data, the expansion module PNOZ mmc12p can also be used for diagnostic and commissioning functions.

The expansion module may only be connected to a base unit from the PNOZmulti system (please refer to the document "PNOZmulti System Expansion" for details of the base units that can be connected).

The configurable small control systems PNOZmulti are used for the safety-related interruption of safety circuits and are designed for use in:

- ▶ E-STOP equipment
- ▶ Safety circuits in accordance with VDE 0113 Part 1 and EN 60204-1

The expansion module may not be used for safety-related functions.

The following is deemed improper use in particular:

- ▶ Any component, technical or electrical modification to the product
- ▶ Use of the product outside the areas described in this manual
- ▶ Use of the product outside the technical details (see [Technical details](#) [ 19]).



NOTICE

EMC-compliant electrical installation

The product is designed for use in an industrial environment. The product may cause interference if installed in other environments. If installed in other environments, measures should be taken to comply with the applicable standards and directives for the respective installation site with regard to interference.

3.2 System requirements

Please refer to the "Product Modifications PNOZmulti" document in the "Version overview" section for details of which versions of the base unit and PNOZmulti Configurator can be used for this product.

3.3 Safety regulations

3.3.1 Use of qualified personnel

The products may only be assembled, installed, programmed, commissioned, operated, maintained and decommissioned by competent persons.

A competent person is someone who, because of their training, experience and current professional activity, has the specialist knowledge required to test, assess and operate the work equipment, devices, systems, plant and machinery in accordance with the general standards and guidelines for safety technology.

It is the company's responsibility only to employ personnel who:

- ▶ Are familiar with the basic regulations concerning health and safety / accident prevention
- ▶ Have read and understood the information provided in this description under "Safety"
- ▶ And have a good knowledge of the generic and specialist standards applicable to the specific application.

3.3.2 Warranty and liability

All claims to warranty and liability will be rendered invalid if

- ▶ The product was used contrary to the purpose for which it is intended
- ▶ Damage can be attributed to not having followed the guidelines in the manual
- ▶ Operating personnel are not suitably qualified
- ▶ Any type of modification has been made (e.g. exchanging components on the PCB boards, soldering work etc.).

3.3.3 Disposal

- ▶ When decommissioning, please comply with local regulations regarding the disposal of electronic devices (e.g. Electrical and Electronic Equipment Act).

3.3.4 For your safety

The unit meets all the necessary conditions for safe operation. However, you should always ensure that the following safety requirements are met:

- ▶ This operating manual only describes the basic functions of the unit. The expanded functions are described in the PNOZmulti Configurator's online help. Only use these functions once you have read and understood the documentations.
- ▶ Do not open the housing or make any unauthorised modifications.
- ▶ Please make sure you shut down the supply voltage when performing maintenance work (e.g. exchanging contactors).

4 Function description

4.1 Functions

The virtual inputs and outputs that are to be transferred via the fieldbus Ethernet POWER-LINK are selected and configured in the PNOZmulti Configurator. The base unit and the fieldbus module PNOZ mmc12p are connected via a jumper. After the supply voltage is switched on or the PNOZmulti control system is reset, the fieldbus module PNOZ mmc12p is configured and started automatically.

LEDs indicate the status of the fieldbus module Ethernet POWERLINK.

The configuration is described in detail in the PNOZmulti Configurator's online help.

4.2 Input and output data

The data is structured as follows:

▶ Input area

The inputs are defined in the Managing Node and transferred to the PNOZmulti. Each input has a number, e.g. input bit 4 of SDO 2100:02 has the number i12.

Virtual inputs PNOZmulti Configurator	I0 ... I7	I8 ... I15	I16 ... I23
Ethernet POWER-LINK	SDO 2100:01: Bit 0 ... 7	SDO 2100:02: Bit 0 ... 7	SDO 2100:03: Bit 0 ... 7

▶ Output range

The outputs are defined in the PNOZmulti Configurator. Each output that is used is given a number there, e.g. o0, o5... The state of output o0 is stored in Bit 0 of SDO 2000:01.

Virtual outputs PNOZmulti Configurator	O0 ... O7	O8 ... O15	O16 ... O23
Ethernet POWER-LINK	SDO 2000:01: Bit 0 ... 7	SDO 2000:02: Bit 0 ... 7	SDO 2000:03: Bit 0 ... 7

Detailed information on data exchange is available in the document "Communication Interfaces" in the section entitled "Fieldbus modules".

The number of virtual inputs and outputs can be extended to 128 (see document "Communication Interfaces" in the section entitled "Fieldbus modules")

4.3 Block diagram

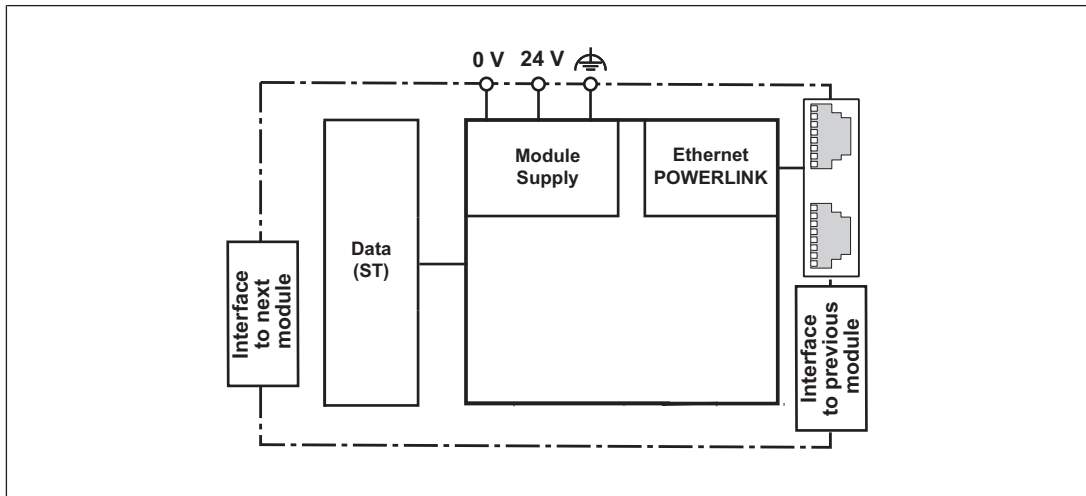

5 Installation

5.1 General installation guidelines

- ▶ The unit should be installed in a control cabinet with a protection type of at least IP54.
- ▶ Fit the safety system to a horizontal mounting rail. The venting slots must face upwards and downwards. Other mounting positions could destroy the safety system.
- ▶ Use the notch on the rear of the unit to attach it to a mounting rail.
- ▶ In environments exposed to heavy vibration, the unit should be secured using a fixing element (e.g. retaining bracket or end angle).
- ▶ Push the unit upwards or downwards before lifting it from the mounting rail.
- ▶ To comply with EMC requirements, the mounting rail must have a low impedance connection to the control cabinet housing.
- ▶ The ambient temperature of the PNOZmulti units in the control cabinet must not exceed the figure stated in the technical details, otherwise air conditioning will be required.



NOTICE

Damage due to electrostatic discharge!

Electrostatic discharge can damage components. Ensure against discharge before touching the product, e.g. by touching an earthed, conductive surface or by wearing an earthed armband.

5.2 Dimensions in mm

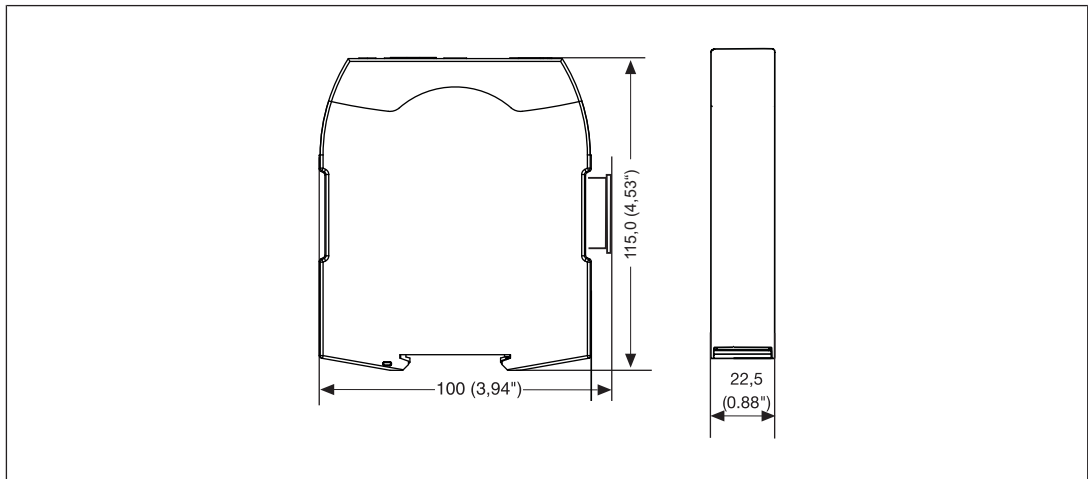

5.3 Connect the base unit and expansion modules

Connect the base unit and the expansion module as described in the operating instructions for the base units.

- ▶ Connect the black/yellow terminator to the expansion module.
- ▶ Install the expansion module in the position in which it is configured in the PNOZmulti Configurator.

The position of the expansion modules is defined in the PNOZmulti Configurator. The expansion modules are connected to the left or right of the base unit, depending on the type.

Please refer to the document "PNOZmulti System Expansion" for details of the number of modules that can be connected to the base unit and the module types.

6 Commissioning

6.1 General wiring guidelines

The wiring is defined in the circuit diagram of the PNOZmulti Configurator. It is possible to define which inputs and outputs on the safety system will communicate with Ethernet POWERLINK.

Please note:

- ▶ Information given in the "[Technical details \[19\]](#)" must be followed.
- ▶ Use copper wiring with a temperature stability of 75 °C.

Please note the following when connecting to Ethernet POWERLINK:

- ▶ The following minimum requirements of the connection cable and connector must be met:
 - Only use standard industrial Ethernet cable and connectors.
 - Only use double-shielded twisted pair cable and shielded RJ45 connectors (industrial connectors).
 - 100BaseTX cable in accordance with the Ethernet standard (min. Category 5)
- ▶ Measures to protect against interference:

Ensure the requirements for the industrial use of Ethernet POWERLINK are met, as stated in the Installation Manual published by the User Group.
- ▶ External measures must be used to connect the  terminal to the function earth (e.g. mounting rail).
- ▶ Always connect the mounting rail to the protective earth via an earthing terminal. This will be used to dissipate hazardous voltages in the case of a fault.
- ▶ The power supply must meet the regulations for extra low voltages with protective separation.



CAUTION!

Only connect and disconnect the expansion module when the supply voltage is switched off.



NOTICE

When installing, you must refer to the guidelines of the Ethernet POWERLINK User Group.

6.2 Connecting the supply voltage

Connect the supply voltage to the fieldbus module:

- ▶ **24 V** terminal: + 24 VDC
- ▶ **0 V** terminal: 0 V
- ▶ Protect the supply voltage as follows:
 - Circuit breaker, characteristic C - 6 A
 - or
 - Blow-out fuse, slow, 6A

6.3 Interface assignment

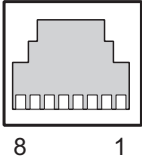
RJ45 socket 8-pin	PIN	Standard
	1	TD+ (Transmit+)
	2	TD- (Transmit-)
	3	RD+ (Receive+)
	4	n.c.
	5	n.c.
	6	RD- (Receive-)
	7	n.c.
	8	n.c.

n.c.: Not connected

6.4 Download modified project to the PNOZmulti system

As soon as an additional expansion module has been connected to the system, the project must be amended using the PNOZmulti Configurator. Proceed as described in the operating instructions for the base unit.



NOTICE

For the commissioning and after every program change, you must check whether the safety devices are functioning correctly.

6.5 Connection example

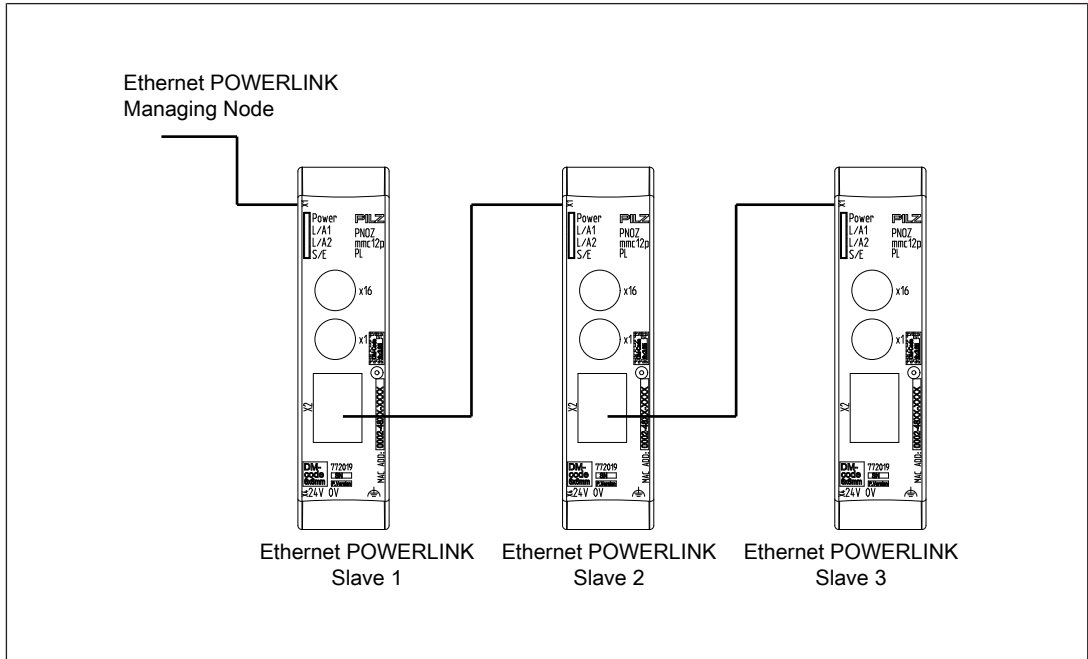

7 Operation





When the supply voltage is switched on, the PNOZmulti safety system copies the configuration from the chip card.









The LEDs “POWER”, “DIAG”, “FAULT”, “IFAULT” and “OFAULT” will light up on the base unit.







The expansion module PNOZ mmc12p is configured and started automatically.

7.1 LED indicators

Legend

-  LED on
-  LED flashes
-  LED flashes briefly
-  LED off

LED			Meaning
Power			Supply voltage is present.
			Supply voltage is not present
L/A1		Green	Bus connection available at X1
		Green	Data traffic present at X1
			Bus connection is not available at X1
L/A2		Green	Bus connection available at X2
		Green	Data traffic present at X2
			Bus connection not available at X2

LED			Meaning
S/E	●		No supply at the bus controller or the bus controller is in a NOT_ACTIVE state. If communication with Ethernet POWERLINK is not detected within 5 s, the bus controller switches to a BASIC_Ethernet state.
		Red	Bus controller in a fault condition (e.g. loss of Ethernet Frames, accumulation of collisions on the network etc.)
		Green	The bus controller has not detected any communication with Ethernet POWERLINK. If communication with Ethernet POWERLINK is detected, the bus switches to a PRE_OPERATIONAL_1 state.
		Green: 1x	The bus controller is in a PRE_OPERATIONAL_1 state.
		Green: 2 x short	The bus controller is in a PRE_OPERATIONAL_2 state.
		Green: 3 x short	The bus controller is in a READY_TO_OPERATE state.
		Green	The bus controller is in an OPERATIONAL state.
		Green	The bus controller is in a STOPPED state.

8 Technical Details

General	
Approvals	CE, EAC (Eurasian), cULus Listed
Electrical data	
Supply voltage	
for	Module supply
Voltage	24 V
Kind	DC
Voltage tolerance	-20 %/+25 %
Max. continuous current that the external power supply must provide	50 mA
Output of external power supply (DC)	1,2 W
Potential isolation	yes
Supply voltage	
for	Module supply
internal	Via base unit
Voltage	3,3 V
Kind	DC
Current consumption	60 mA
Power consumption	0,2 W
Max. power dissipation of module	1,5 W
Status indicator	LED
Fieldbus interface	
Fieldbus interface	Ethernet POWERLINK V2
Device type	Controlled Node
Transmission rates	100 MBit/s
Connection	RJ45
Galvanic isolation	yes
Times	
Supply interruption before de-energisation	20 ms
Environmental data	
Ambient temperature	
In accordance with the standard	EN 60068-2-14
Temperature range	0 - 60 °C
Forced convection in control cabinet off	55 °C
Storage temperature	
In accordance with the standard	EN 60068-2-1/-2
Temperature range	-25 - 70 °C
Climatic suitability	
In accordance with the standard	EN 60068-2-30, EN 60068-2-78
Condensation during operation	Not permitted
Max. operating height above sea level	2000 m
EMC	EN 61131-2

Environmental data	
Vibration	
In accordance with the standard	EN 60068-2-6
Frequency	10 - 150 Hz
Acceleration	1g
Shock stress	
In accordance with the standard	EN 60068-2-27
Acceleration	15g
Duration	11 ms
Airgap creepage	
In accordance with the standard	EN 61131-2
Overvoltage category	II
Pollution degree	2
Rated insulation voltage	30 V
Protection type	
In accordance with the standard	EN 60529
Housing	IP20
Terminals	IP20
Mounting area (e.g. control cabinet)	IP54
Potential isolation	
Potential isolation between	Fieldbus and module voltage
Type of potential isolation	Functional insulation
Rated surge voltage	500 V
Mechanical data	
Mounting position	Horizontal on top hat rail
DIN rail	
Top hat rail	35 x 7,5 EN 50022
Recess width	27 mm
Material	
Bottom	PC
Front	PC
Top	PC
Connection type	Spring-loaded terminal, screw terminal
Conductor cross section with screw terminals	
1 core flexible	0,25 - 2,5 mm², 24 - 12 AWG
2 core with the same cross section, flexible without crimp connectors or with TWIN crimp connectors	0,2 - 1,5 mm², 24 - 16 AWG
Torque setting with screw terminals	0,5 Nm
Conductor cross section with spring-loaded terminals:	
Flexible with/without crimp connector	0,2 - 2,5 mm², 24 - 12 AWG
Spring-loaded terminals: Terminal points per connection	2
Stripping length with spring-loaded terminals	9 mm

Mechanical data

Dimensions

Height	100 mm
Width	22,5 mm
Depth	110,4 mm

Weight	90 g
--------	-------------

Where standards are undated, the 2015-08 latest editions shall apply.

9 Order reference

9.1 Product

Product type	Features	Order no.
PNOZ mmc12p	Fieldbus module, Ethernet POWERLINK	772 019

9.2 Accessories

Connection terminals

Product type	Features	Order no.
Spring terminals PNOZ mmcxp 1 pc.	Spring-loaded terminals, 1 pieces	783 542
Spring terminals PNOZ mmcxp 10 pcs.	Spring-loaded terminals, 10 pieces	783 543
Screw terminals PNOZ mmcxp 1 pc.	Screw terminals, 1 piece	793 542
Screw terminals PNOZ mmcxp 10 pcs.	Screw terminals, 10 pieces	793 543

Terminator, jumper

Product type	Features	Order No.
PNOZ mm0.xp connector left	Jumper yellow/black to connect the modules, 10 piece	779 260

► Support

Technical support is available from Pilz round the clock.

Americas

Brazil

+55 11 97569-2804

Canada

+1 888-315-PILZ (315-7459)

Mexico

+52 55 5572 1300

USA (toll-free)

+1 877-PILZUSA (745-9872)

Asia

China

+86 21 60880878-216

Japan

+81 45 471-2281

South Korea

+82 31 450 0680

Australia

+61 3 95600621

Europe

Austria

+43 1 7986263-0

Belgium, Luxembourg

+32 9 3217575

France

+33 3 88104000

Germany

+49 711 3409-444

Ireland

+353 21 4804983

Italy, Malta

+39 0362 1826711

Scandinavia

+45 74436332

Spain

+34 938497433

Switzerland

+41 62 88979-30

The Netherlands

+31 347 320477

Turkey

+90 216 5775552

United Kingdom

+44 1536 462203

You can reach our international hotline on:

+49 711 3409-444

support@pilz.com

Pilz develops environmentally-friendly products using ecological materials and energy-saving technologies. Offices and production facilities are ecologically designed, environmentally-aware and energy-saving. So Pilz offers sustainability, plus the security of using energy-efficient products and environmentally-friendly solutions.

Energy
saving by Pilz



Pilz GmbH & Co. KG
Felix-Wankel-Straße 2
73760 Ostfildern, Germany
Tel.: +49 711 3409-0
Fax: +49 711 3409-133
info@pilz.com
www.pilz.com

PILZ
THE SPIRIT OF SAFETY