



Operating Instructions

IO-Link Master with EtherNet/IP Interface
PowerLine
8 Ports
IP 65 / IP 66 / IP 67

AL1222

HW Revision: AB
Firmware: 2.3.x
LR DEVICE: 1.5.0.x

English

Contents

1	Preliminary note	5
1.1	Legal and copyright information	5
1.2	Purpose of the document	5
1.3	Explanation of Symbols	6
1.4	Modification history	6
2	Safety instructions	7
2.1	General	7
2.2	Required background knowledge	7
2.3	Safety symbols on the device	7
2.4	Tampering with the unit	7
3	Intended use	8
3.1	Permitted use	8
3.2	Prohibited use	8
4	Function	9
4.1	Communication, parameter setting, evaluation	10
4.1.1	IO-Link	10
4.1.2	EtherNet/IP	10
4.1.3	Parameter setting	11
4.1.4	Visual indication	11
4.2	Digital inputs	11
4.3	IO-Link supply	11
4.4	Voltage output	11
5	Mounting	12
5.1	Mount the device	12
6	Electrical connection	13
6.1	Notes	13
6.2	Ethernet ports	14
6.3	IO-Link Ports	15
6.4	Connect the device	16
7	Operating and display elements	17
7.1	Overview	17
7.2	LED indicators	18
7.2.1	Status LEDs	18
7.2.2	Ethernet interface	18
7.2.3	Voltage supply	19
7.2.4	IO-Link ports (Class A)	19
7.2.5	IO-Link ports (Class B)	19

8	Set-up	20
8.1	Read device and diagnostic information	21
9	Configuration	22
9.1	LR DEVICE	23
9.1.1	Remarks	24
9.1.2	IoT: Configure access rights	25
9.1.3	IoT: Configure the interface to LR AGENT or LR SMARTOBSERVER	26
9.1.4	Fieldbus: Configure IP settings	27
9.1.5	Fieldbus: set the configuration mode	28
9.1.6	IO-Link ports: Activate data transfer to LR AGENT or LR SMARTOBSERVER	29
9.1.7	IO-Link ports: Configure operating mode	30
9.1.8	IO-Link ports: Set the device validation and data storage	31
9.1.9	IO-Link Ports: Set fails-safe values	32
9.1.10	Info: Show device information	32
9.1.11	Firmware: Reset device to factory settings	33
9.1.12	Firmware: Reboot the device	33
9.1.13	Configure IO-Link devices	34
9.2	EtherNet/IP	35
9.2.1	Registration of the EDS file	35
9.2.2	Integrate the AL1222 into the EtherNet/IP project	36
9.2.3	Set connection types and RPI	37
9.2.4	Configure AL1222	38
9.2.5	Configure IO-Link ports	39
9.2.6	Configure IO-Link devices	41
9.2.7	Read cyclic input data	42
9.2.8	Write cyclic output data	42
9.2.9	Read diagnostic and status information	43
9.2.10	EtherNet/IP: Programmers' notes	44
10	Maintenance, repair and disposal	47
10.1	Cleaning process	47
10.2	Firmware update	48
10.3	Replace IO-Link device	49
11	Factory Settings	50
12	Accessories	51
13	Appendix	52
13.1	Technical data	53
13.1.1	Application	53
13.1.2	Electrical data	53
13.1.3	Inputs / outputs	55
13.1.4	Inputs	55
13.1.5	Outputs	55
13.1.6	Interfaces	55
13.1.7	Operating conditions	56
13.1.8	Mechanical data	56
13.1.9	Approvals / tests	56
13.1.10	Electrical connection	57
13.2	EtherNet/IP	58
13.2.1	Supported connection types	58
13.2.2	Parameter data	59
13.2.3	Cyclic data	63

13.2.4 Acyclic data74

14 Index 109

1 Preliminary note

Content

Legal and copyright information	5
Purpose of the document	5
Explanation of Symbols	6
Modification history	6

33203

1.1 Legal and copyright information

33117

© All rights reserved by ifm electronic gmbh. No part of this manual may be reproduced and used without the consent of ifm electronic gmbh.

All product names, pictures, companies or other brands used on our pages are the property of the respective rights owners:

- AS-i is the property of the AS-International Association, (→ www.as-interface.net)
- CAN is the property of the CiA (CAN in Automation e.V.), Germany (→ www.can-cia.org)
- CODESYS™ is the property of the 3S – Smart Software Solutions GmbH, Germany (→ www.codesys.com)
- DeviceNet™ is the property of the ODVA™ (Open DeviceNet Vendor Association), USA (→ www.odva.org)
- EtherNet/IP® is the property of the → ODVA™
- EtherCAT® is a registered trade mark and patented technology, licensed by Beckhoff Automation GmbH, Germany
- IO-Link® is the property of the → PROFIBUS Nutzerorganisation e.V., Germany (→ www.io-link.com)
- ISOBUS is the property of the AEF – Agricultural Industry Electronics Foundation e.V., Deutschland (→ www.aef-online.org)
- Microsoft® is the property of the Microsoft Corporation, USA (→ www.microsoft.com)
- Modbus® is the property of the Schneider Electric SE, France (→ www.schneider-electric.com)
- PROFIBUS® is the property of the PROFIBUS Nutzerorganisation e.V., Germany (→ www.profibus.com)
- PROFINET® is the property of the → PROFIBUS Nutzerorganisation e.V., Germany
- Windows® is the property of the → Microsoft Corporation, USA

1.2 Purpose of the document

34227

This document is only for device types "IO-Link master - EtherNet/IP gateway (PowerLine) 8 port IP 65 / IP 66 / IP 67" (art. no.: AL1222).

It is part of the device and contains information about the correct handling of the product.

- ▶ Read this document before using the device.
- ▶ Keep this document during the service life of the device.

1.3 Explanation of Symbols

34171



WARNING!

Death or serious irreversible injuries may result.



CAUTION!

Slight reversible injuries may result.



NOTICE!

Property damage is to be expected or may result.



Important note

Non-compliance can result in malfunction or interference



Information

Supplementary note



Request for action



Reaction, result



"see"

abc

Cross-reference

123

Decimal number

0x123

Hexadecimal number

0b010

Binary number

[...]

Designation of pushbuttons, buttons or indications

1.4 Modification history

54745

Version	Topic	Date
00	New creation of document	11 / 2018
01	Update to firmware 2.3.x <ul style="list-style-type: none"> ▪ Added: Configure Explicit PD Mode 	04 / 2019
02	Corrected: Technical data - Max. current load per output	09 / 2019

2 Safety instructions

Content

General.....	7
Required background knowledge.....	7
Safety symbols on the device.....	7
Tampering with the unit.....	7

28333

2.1 General

33834



The plant manufacturer is responsible for the safety of the plant in which the device is installed.

If the device is used in a way that is not intended by the manufacturer, the protection supported by the device may be impaired.

Non-observance of the instructions, operation which is not in accordance with use as prescribed below, wrong installation or incorrect handling can affect the safety of operators and machinery.

- ▶ Observe these operating instructions.
- ▶ Adhere to the warning notes on the product.

2.2 Required background knowledge

34185

This document is intended for specialists. Specialists are people who, based on their relevant training and experience, are capable of identifying risks and avoiding potential hazards that may be caused during operation or maintenance of the product.

The document contains information about the correct handling of the product.

2.3 Safety symbols on the device

34199



General warning

Observe instructions in chapter "Electrical connection" (→ **Electrical connection** (→ S. [13](#)))!

2.4 Tampering with the unit

33190



WARNING!

Tampering with the unit.

- > In case of non-compliance:
 - Possible affects on safety of operators and machinery
 - Expiration of liability and warranty
- ▶ Do not open the devices!
- ▶ Do not insert any objects into the devices!
- ▶ Prevent metal foreign bodies from penetrating!

3 Intended use

Content

Permitted use	8
Prohibited use.....	8

34079

3.1 Permitted use

34209

The IO-Link master serves as a gateway between intelligent IO-Link devices and the EtherNet/IP network. The device is designed for use without a control cabinet in the plant construction.

3.2 Prohibited use

34228

The device may not be used beyond the limits of the technical data (→ **Technical data** (→ S. [53](#)))!

4 Function

Content

Communication, parameter setting, evaluation	10
Digital inputs	11
IO-Link supply.....	11
Voltage output	11

33836

4.1 Communication, parameter setting, evaluation

Content

IO-Link	10
EtherNet/IP	10
Parameter setting	11
Visual indication.....	11

33860

4.1.1 IO-Link

34084

The device offers the following IO-Link functions:

- IO-Link master (IO-Link revision 1.0 and 1.1)
- 8 IO-Link ports for connection of IO-Link devices
- Provision of process data of the connected IO-Link devices for LR SMARTOBSERVER monitoring software (→ www.ifm.com)

4.1.2 EtherNet/IP

52585

The device offers the following EtherNet/IP functions:

- EtherNet/IP Device
- 2 port switch for access to the EtherNet/IP interface
- Gateway for transmission of the process and parameter data between the connected IO-Link devices and the higher-level EtherNet/IP controller
- Min. cycle time: 1 ms (RPI)
- Connection classes: 1, 3
- Connection Application types: Exclusive Owner, Input Only, Listen Only Connections
- UCMM supported
- Predefined standard objects:
 - Identity Object (0x01)
 - Message Router Object (0x02)
 - Assembly Object (0x04)
 - Connection Manager (0x06)
 - DLR Object (0x47)
 - QoS Object (0x48)
 - TCP/IP Interface Object (0xF5)
 - Ethernet Link Object (0xF6)
- Supported protocols: DHCP, BOOTP, ACD, DLR
- Device description: EDS file

4.1.3 Parameter setting

34583

The device provides the following configuration options:

- Parameter setting of the IO-Link master of the AL1222 with parameter setting software LR DEVICE and/or EtherNet/IP projection software
- Parameter setting of the connected IO-Link devices (sensors, actuators) with parameter setting software LR DEVICE and/or EtherNet/IP projection software
- Storage of parameter sets of the connected IO-Link devices for automatic recovery (data storage)

4.1.4 Visual indication

34192

The device has the following visual indicators:

- Status and error indication of the gateway, of the EtherNet/IP connection and of the system
- Status display of the voltage supply
- Status and activity display of the Ethernet connection
- Status, error and short circuit/overload indication of the IO-Link ports

4.2 Digital inputs

33817

The device has 4 additional digital inputs (type 2 according to EN 61131-2).

The digital inputs are on pin 2 of the IO-Link ports X01...X04.

All inputs refer to the potential of the device supply (pin 3).

4.3 IO-Link supply

34587

The device has 8 supplies for IO-Link devices (sensors, actuators).

The IO-Link ports X01...X04 are Class-A ports. The IO-Link interfaces X05...X08 are Class-B ports.

Every supply provides short circuit monitoring.

The device ensures fire protection for connected IO-Link devices by providing an energy-limited circuit at the IO-Link ports (to IEC61010-1 and Class 2 to UL1310).

4.4 Voltage output

34592

The device has a voltage output (X32) for the supply of an additional device. That means that several devices of type "PowerLine" can be supplied via one single voltage source (daisy chain).

5 Mounting

Content

Mount the device	12
------------------------	----

34058

5.1 Mount the device

34059



- ▶ Disconnect the system from power before installation.
 - ▶ For installation choose a flat mounting surface.
 - ▶ Please observe the maximum tightening torque.
-
- ▶ Fix the unit to the mounting surface using 2 M5 mounting screws and washers.
 - Tightening torque: 1.8 Nm
 - ▶ Ground the unit via the two mounting screws of the upper mounting lugs.

6 Electrical connection

Content

Notes	13
Ethernet ports	14
IO-Link Ports.....	15
Connect the device.....	16

33805

6.1 Notes

51957



A qualified electrician must connect the unit.

- ▶ The national and international regulations setting up electrical equipment must be complied with.

The unit is only suitable for operation using SELV/PELV voltages.

- ▶ Please note the information concerning IO-Link wiring!

This unit contains components that may be damaged or destroyed by electrostatic discharge (ESD).

- ▶ Please observe the required precautions against electrostatic discharge!

The IP rating of the overall system depends on the protection ratings of the individual devices, the applied connection elements and the corresponding protective caps.

- ▶ Provide cables with a strain relief depending on the mounting conditions to avoid excessive strain on the installation points and the M12 connections.
- ▶ Ensure correct fit and proper assembly of the M12 connecting parts. If these instructions are not complied with, the specified protection rating cannot be guaranteed.

For UL applications:

- ▶ To connect the IO-Link master and the IO-Link devices, only use UL-certified cables of the CYJV or PVVA category with a minimum temperature of 80 °C (75 °C in case of maximum ambient temperature of 40 °C).

Wiring: → **Technical data** (→ S. [53](#))

By means of basic insulation according to EN61010-1, the circuits are separated from each other and from device surfaces that could be touched (secondary circuit with 30 V DC maximum, supplied from mains circuit up to 300 V overvoltage category II).

By means of basic insulation according to EN61010-1, the communication interfaces are separated from each other and from device surfaces that could be touched (secondary circuit with 30 V DC maximum, supplied from mains circuit up to 300 V overvoltage category II). They are designed for network environment 0 according to IEC TR62102.

6.2 Ethernet ports

34576

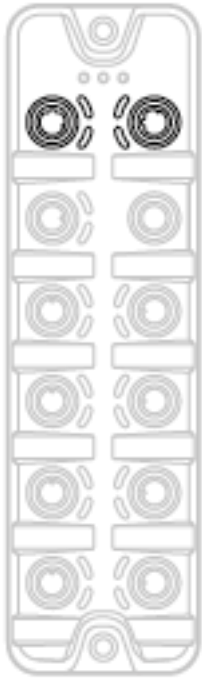

- ▶ Connect the unit via the M12 socket X21 and/or X22 with the EtherNet/IP network (e.g. EtherNet/IP PLC, additional EtherNet/IP device)
 - Tightening torque: 0.6...0.8 Nm
- ▶ Connect the unit via the M12 socket X21 and/or X22 to the industrial Ethernet network (e.g. laptop/PC with installed parameter setting software LR DEVICE, laptop/PC with installed monitoring software LR SMARTOBSERVER)
 - Tightening torque: 0.6...0.8 Nm
- ▶ For the connection, use M12 connectors with protection rating IP 65 / IP 66 / IP 67 or higher (→ **Accessories** (→ S. [51](#))).
- ▶ Cover the unused sockets with M12 protective caps (art no. E73004).
 - Tightening torque 0.6...0.8 Nm

6.3 IO-Link Ports

52465

Notes on wiring:

- The IO-Link ports of the AL1222 meet the requirements of the IO-Link specifications 1.0 to 1.1.2.
- The connected IO-Link devices must be supplied exclusively via the IO-Link master.
- The additional digital inputs IO-Link ports X01...X04 (pin 2) have a type 2 behaviour according to the standard EN61131-2. The connected electronics must be electrically suited for this.

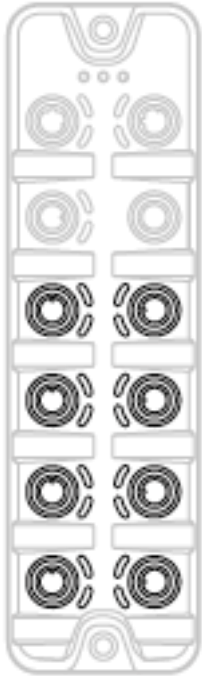

- ▶ Connect the connectors of the IO-Link devices with the M12 sockets X01...X04 (Ports Class A).
 - Tightening torque: 0.6...0.8 Nm
 - Maximum cable length per IO-Link port: 20 m
- ▶ Connect the connectors of the IO-Link devices with higher power requirements with the M12 sockets <IOL_Ports_ClassB (Ports Class B).
 - Tightening torque: 0.6...0.8 Nm
 - Maximum cable length per IO-Link port: 20 m
- ▶ To connect the devices, use M12 connectors with protection rating IP 65 / IP 66 / IP 67 or higher (→ **Accessories** (→ S. [51](#))).
- ▶ Cover unused sockets with M12 protective caps (art. no.: E73004).
 - Tightening torque 0.6...0.8 Nm

6.4 Connect the device



CAUTION!

Exceeding the maximum input current of 12 A

- > Fire hazard
- ▶ Select I_U and I_A of the power supplies US and UA taking into account the derating characteristics of the AL1222 (→ **Derating characteristics** (→ S. 54))!



- ▶ Disconnect power.
- ▶ Connect device via the M12 socket X31 to US and UA supplying 24 V DC each (20...30 V SELV/PELV; to IEC 61010-1, secondary circuit with maximum 30 V DC, supplied by mains circuit up to 300 V of overvoltage category II).
 - Tightening torque: 0.6...0.8 Nm.
 - Maximum cable length: 25 m
- ▶ To connect the device, use T-coded M12 connectors with protection rating IP 65 / IP 66 / IP 67 or higher (→ **Accessories** (→ S. 51)).

Optional: Supply of an additional PowerLine devices (Daisy chain):

- ▶ Connect device via the M12 socket X31 to M12 socket of the voltage output X32 of the requested AL12nn.
 - Tightening torque: 0.6...0.8 Nm
 - Maximum cable length: 25 m
- ▶ To connect the device, use T-coded M12 connectors with protection rating IP 65 / IP 66 / IP 67 or higher (→ **Accessories** (→ S. 51))



When using connectors longer than 25 m keep in mind the voltage drop as well as the required minimum voltage supply of the AL1222.

7 Operating and display elements

Content

Overview.....	17
LED indicators.....	18

34063

7.1 Overview

34582

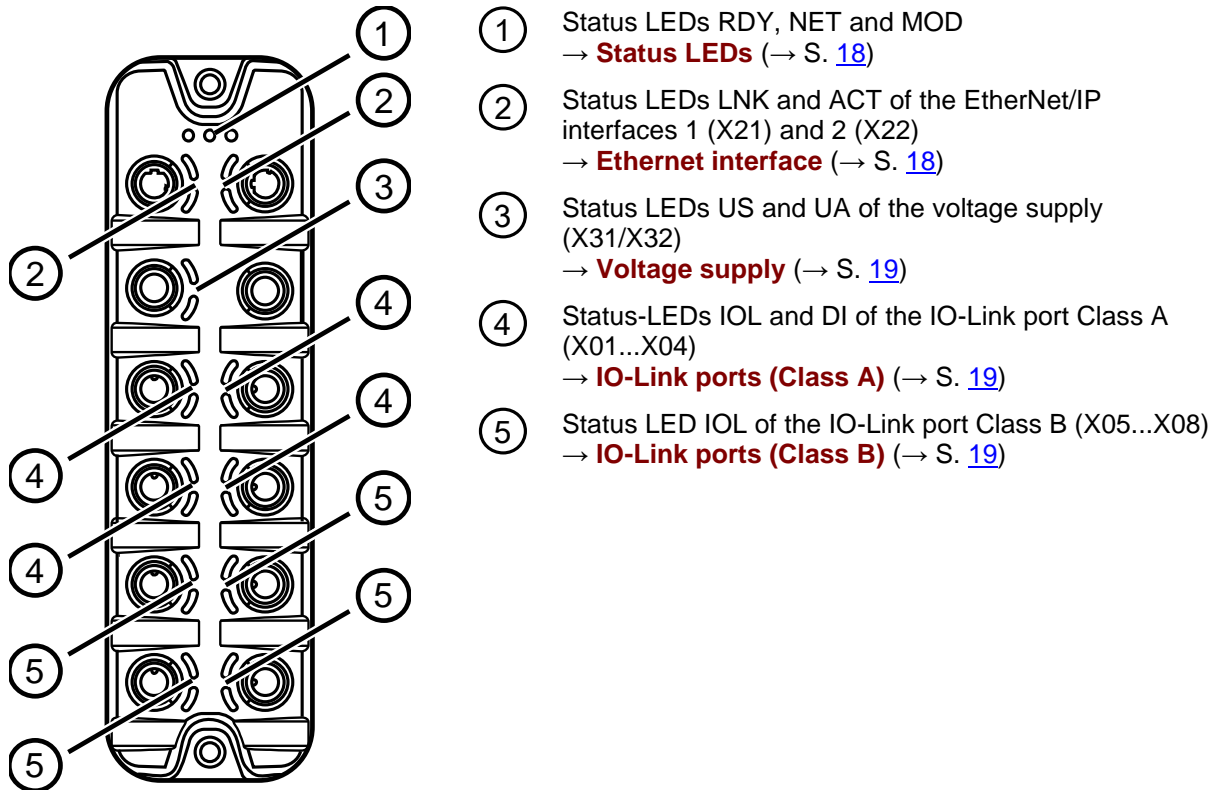

7.2 LED indicators

34047

The device only has the following LED indicators:

7.2.1 Status LEDs

34408

The RDY LED indicates the status of the gateway.

The NET LED (Network Status) indicates the status of the network.

The MOD LED (Module Status) indicates the status of the EtherNet/IP module.

Status LED			Description
RDY	green	on	Status: OK
		flashes 5 Hz	Status: Error
		flashes (200 ms on, 800 ms off)	Status: Firmware update is running
		off	Status: Gateway not running or gateway booting
NET	green / red	off	Not powered or powered, but IP address not yet configured
		flashes	Device self-testing
	green	flashes	No connection: no CIP connection established and a Exclusive Owner connection has not timed out
		on	Connection: at least one CIP connection established and an Exclusive Owner connection has not timed out
	red	flashes	Connection timeout: an Exclusive Owner connection has timed out
		on	Duplicate IP address: IP address already in use
MOD	green / red	off	No voltage or voltage too low
		flashes	Device self-testing
	green	flashes	Standby: device not yet configured (no IP address)
		on	Operational
	red	flashes	Major recoverable fault (e.g. incorrect configuration)
		on	Major unrecoverable fault (e.g. module failed)

7.2.2 Ethernet interface

34348

Each Ethernet interface (X21, X22) has 2 LEDs (LNK and ACT). The LEDs indicate the status of the Ethernet connection.

Status LED			Description
LNK	green	on	Ethernet connection established
		off	No Ethernet connection
ACT	yellow	flashes	Data is transmitted via the Ethernet interface.
		off	No data transmission

7.2.3 Voltage supply

34590

The interface for voltage supply (X31) has the LEDs that are marked as US and UA. The LEDs indicate the status of the voltage supply:

Status LED			Description
US	green	lights	The supply voltage US is applied.
		off	No supply voltage is applied or the applied supply voltage is too low.
UA	green	lights	The supply voltage UA for IO-Link device port class B is applied.
		off	No supply voltage is applied or the applied supply voltage is too low.

7.2.4 IO-Link ports (Class A)

34074

Each IO-Link port Class A has 2 LEDs marked as IOL and DI. The LEDs indicate the status of the IO-Link port.

Status LED			Description
IOL	yellow	off	Port configured as DI / DO: pin 4 (C/Q) = OFF
		on	Port configured as DI / DO: pin 4 (C/Q) =ON
	green	flashes 1 Hz	Port configured as IO-Link: no IO-Link device detected
		flashes 2 Hz	Port configured as IO-Link: PROOPERATE state
		on	Port configured as IO-Link: OPERATE state
	red	flashes 2 Hz	Port configuration error or short circuit or overload (US)
		on	Transmission error
DI	yellow	off	Digital input : pin 2 (DI) = OFF
		on	Digital input: pin 2 (DI) = ON

7.2.5 IO-Link ports (Class B)

34588

Each IO-Link port Class B has the LED with the description IOL. The LEDs indicate the status of the IO-Link port.

Status LED			Description
IOL	yellow	on	Port configured as DI/DO: pin 4 (C/Q) = ON
		off	Port configured as DI/DO: pin 4 (C/Q) = OFF
	green	on	IO-Link transmission functions properly
		flashing 1 Hz	Port configured as IO-Link, but no IO-Link transmission
	red	on	Short circuit or overload in supply voltage
		flashing 1 Hz	Transmission error

8 Set-up

Content

Read device and diagnostic information	21
--	----

52476

When the supply voltage has been switched on, the AL1222 starts with the factory settings. The display elements signal the current operating status (→ **Operating and display elements** (→ S. [17](#))).

To enable parameter setting of the AL1222, the fieldbusinterface of the network environment must be configured correspondingly.

- ▶ Configure the fieldbus interface (ports X21 / X22) (→ **Fieldbus: Configure IP settings** (→ S. [27](#)) or → **Integrate the AL1222 into the EtherNet/IP project** (→ S. [36](#))).
- > The fieldbus interface has valid IP settings.
- > The user can set the parameters of the AL1222.

Further steps:

- Optional: Update the firmware of the AL1222 (→ **Firmware update** (→ S. [48](#))).
- Set the parameters of the AL1222 (→ **Configuration** (→ S. [22](#))).

8.1 Read device and diagnostic information

In order to read the diagnostic information about the current device status via the web interface:

- ▶ Connect laptop/PC and AL1222 via the Ethernet internet.
- ▶ Start web browser.
- ▶ Enter the IP address of the AL1222 into the address field of the browser and press [ENTER] to confirm.
- > Web browser shows the web interface of the device.
- > The page shows the following data:
 - Table with connected IO-Link devices

Name	Description
[Port]	Number of the IO-Link interface
[Mode]	Operating mode of the IO-Link interface
[Comm. Mode]	Baud rate of the IO-Link interface
[MasterCycleTime]	Cycle time
[Vendor ID]	ID of the manufacturer of the IO-Link device
[Device ID]	ID of the IO-Link device
[Name]	Article number of the IO-Link device <ul style="list-style-type: none"> ▪ For ifm articles: This article number is stored along with a link to the produkt page on the ifm website.
[Serial]	Serial number of the IO-Link device
[LR Mode / Interval]	Cycle time for the communication with the SmartObserver

- Diagnostic information of the device

Name	Description
[SW-Version]	
[Current]	Current (in mA)
[Voltage]	Voltage (in mV)
[Short Circuit]	Number of detected short circuits
[Overload]	Number of detected overloads
[Undervoltage]	Number of detected under voltages
[Temperature]	Device temperature (in °C)

- Version information of the installed firmware components

Name	Description
[Firmware]	Firmware version
[Container]	Version of the firmware container
[Bootloader Version]	Version of the boot loader
[Fieldbus Firmware]	Version of the EtherNet/IP firmware

9 Configuration

Content

LR DEVICE	23
EtherNet/IP	35

33858

9.1 LR DEVICE

Content

Remarks	24
IoT: Configure access rights	25
IoT: Configure the interface to LR AGENT or LR SMARTOBSERVER	26
Fieldbus: Configure IP settings	27
Fieldbus: set the configuration mode	28
IO-Link ports: Activate data transfer to LR AGENT or LR SMARTOBSERVER	29
IO-Link ports: Configure operating mode	30
IO-Link ports: Set the device validation and data storage.....	31
IO-Link Ports: Set fails-safe values.....	32
Info: Show device information	32
Firmware: Reset device to factory settings	33
Firmware: Reboot the device.....	33
Configure IO-Link devices	34

33692

On delivery, the AL1222 is configured with the factory settings (→ **Factory Settings** (→ S. [50](#))).

Required software: LR DEVICE (1.5.0.x or higher) (art.-no.: QA0011/QA0012)

9.1.1 Remarks

Content

Offline parameter setting	24
VPN connection	24

34180

Offline parameter setting

34060

The AL1222 supports the offline parameter setting. In this context, the user creates and stores a configuration for the IO-Link master and the connected IO-Link devices without being connected to the AL1222 (OFFLINE mode). The configuration created in this way can be stored as a file (*.lrp) and loaded to the AL1222 and activated at a later date.



Further information about offline parameter setting: → Operating instructions LR DEVICE

VPN connection

34382



An active VPN connection blocks the access of the parameter setting software LR DEVICE to the EtherNet/IP interface of the AL1222.

- ▶ Deactivate the VPN connection in order to be able to access the AL1222 with the LR DEVICE.

9.1.2 IoT: Configure access rights

The access rights define which instance may read and / or write the parameter data, process data and event/diagnostic messages.

In order to configure the access rights to the IO-Link master:

- ▶ Select [IoT] menu.
- > The menu page shows the current settings.
- ▶ Set the following parameters as required:

Name	Description	Possible values
[Access Rights]	The access rights to the parameter data, process data and the event/diagnostic messages of the IO-Link master as well as the connected IO-Link devices	[EtherNet/IP + IoT] <ul style="list-style-type: none"> ▪ EtherNet/IP and IoT Core have read and write access rights to parameters and process data ▪ EtherNet/IP and <IoT Core> have read access rights to events/alarms
		[EtherNet/IP + IoT (read-only)] <ul style="list-style-type: none"> ▪ EtherNet/IP has read and write access rights to parameters and process data ▪ EtherNet/IP has read access rights to events/alarms ▪ IoT Core only has read access rights to parameters, process data and events/alarms
		[IoT only] <ul style="list-style-type: none"> ▪ IoT Core has read and write access rights to parameters and process data ▪ IoT has read access rights to events/alarms ▪ EtherNet/IP has no access rights

- ▶ Save changed values on the device.



If the parameter [Access rights] is set to [EtherNet/IP + IoT] via IoT and EtherNet/IP projection, then the parameter values set in the EtherNet/IP projection software apply.

If the parameter [Access rights] is set to [IoT only] via IoT, then set the parameter [Access rights] to [Keep settings] in the EtherNet/IP projection software.

Changes of the parameter [Access Rights] are only effective after restarting the device (→ **Firmware: Reboot the device** (→ S. [33](#)))

9.1.3 IoT: Configure the interface to LR AGENT or LR SMARTOBSERVER

To enable transfer of process data from the IO-Link master to LR AGENT or LR SMARTOBSERVER, the interface has to be configured accordingly.

- ▶ Select [IoT] menu.
- > The menu page shows the current settings.
- ▶ Set the following parameters as required:

Name	Description	Possible values	
[IP address LR Agent or SMARTOBSERVER]	IP address of LR AGENT or LR SMARTOBSERVER	Factory setting: 255.255.255.255	
[Port LR Agent or SMARTOBSERVER]	Port number that is used to send process data to LR AGENT or LR SMARTOBSERVER	0 ... 65535	Factory setting: 35100
[Interval LR Agent or SMARTOBSERVER]	Cycle time for the transfer of the process data to LR AGENT or LR SMARTOBSERVER (value in milliseconds)	[Off]	no transfer
		500 ... 2147483647	500 ms ... 2147483647 ms
[Application Tag]	Source identifier of the IO-Link master in the structure of LR AGENT or LR SMARTOBSERVER (String32)	Factory setting: AL1222	



After changing the parameter [Port LR Agent or SMARTOBSERVER] or [Application Tag], it may take 120 seconds before the device establishes a new TCP connection.

To prevent the delay:

- ▶ Reboot the device after changing the the parameter.
- ▶ Save changed values on the device.

9.1.4 Fieldbus: Configure IP settings

For communication with the EtherNet/IP network, the EtherNet/IP interface must be configured.

- ▶ Select [Fieldbus] menu.
- > The menu page shows the current settings.
- ▶ Set the following parameters as required:

Name	Description	Possible values	
[DHCP]	Enable / disable the DHCP client of the device	[Static IP]	IP parameters are set by the user
		[DHCP]	IP parameters are set by a DHCP server in the network.
		[BOOTP]	IP parameters are set via the Bootstrap Protocol (BOOTP)
[IP address]*	IP address of the EtherNet/IP port	Factory setting: 192.168.1.250	
[Subnet mask]*	Subnet mask of the IP network	Factory setting: 255.255.255.0	
[Default gateway IP address]*	IP address of the gateway	Factory setting: 0.0.0.0	
[Host name]	Name of the device in the EtherNet/IP network	e.g. al1xxx	
[MAC address]	MAC address of the device	The value is firmly set.	
[Fieldbus firmware]		e.g. 3.4.04 (EtherNet/IP Adapter)	

* ... Parameter can only be edited if parameter [DHCP] = [Static IP]

- ▶ Save changed values on the device.

9.1.5 Fieldbus: set the configuration mode

The AL1222 supports the EtherNet/IP configuration modes "top-down" and "independent". Additionally, the user can configure the length of the transmitted process data and select the required connection types.

- ▶ Select [Fieldbus] menu.
- > The menu page shows the current settings.
- ▶ Set the following parameters as required:

Name	Description	Possible values	
[Configuration]*	EtherNet/IP configuration mode	Independent mode off	Configuration via fieldbus PLC
		Independent mode on	Configuration via AL1222
[Process data length]*	Length of process data per IO-Link port	2 bytes input 2 bytes output	2 bytes input data, 2 bytes output data
		4 bytes input 4 bytes output	4 bytes input data, 4 bytes output data
		8 bytes input 8 bytes output	8 bytes input data, 8 bytes output data
		16 bytes input 16 bytes output	16 bytes input data, 16 bytes output data
		32 bytes input 32 bytes output	32 bytes input data, 32 bytes output data
[Swap]*	Sequence of bytes in the data word	off	as Array of Bytes
		on	as Integer16 value; during an update of the process data, the bytes are exchanged
[Explicitpdmode]**	Enable / disable explicit PD mode and select the process data to be transmitted (connection types)	Explicit process data mode off	Explicit PD mode disabled
		Explicit process data mode with IO-Link I/O + Acyclic + Diag	Explicit PD mode enabled: IO-Link inputs /outputs, acyclic data and diagnostic data are transmitted
		Explicit process data mode with IO-Link I/O + Acyclic	Explicit PD mode enabled: IO-Link inputs/outputs and acyclic data are transmitted
		Explicit process data mode with IO-Link I/O	Explicit PD mode enabled: IO-Link inputs/outputs are transmitted

* ... Parameter can only be changed if the EtherNet/IP controller is disconnected

** ... Parameter only valid if [Configuration] = [Independent mode on]

- ▶ Save changed values on the device.

9.1.6 IO-Link ports: Activate data transfer to LR AGENT or LR SMARTOBSERVER

33690

The user can decide separately for each IO-Link port whether the process data of the connected IO-Link devices should be transferred to LR AGENT or LR SMARTOBSERVER.



To transfer process data the interface to the LR AGENT or LR SMARTOBSERVER has to be correctly configured (→ **IoT: Configure the interface to LR AGENT or LR SMARTOBSERVER** (→ S. [26](#))).

To activate / deactivate data transfer:

- ▶ Select [Port x] menu (x = 1..8).
- > The menu page shows the current settings.
- ▶ Set the following parameters as required:

Name	Description	Possible values	
[Transmission to LR Agent or SMARTOBSERVER]	Transfer of process data of the connected IO-Link device to LR AGENT oder LR SMARTOBSERVER	[Disabled]	Transfer process data
		[Enabled]	Don't transfer process data

- ▶ Save changed values on the device.

9.1.7 IO-Link ports: Configure operating mode

The IO-Link ports X01...X08 of the device support the following operating modes:

- Digital input (DI): binary input signal at pin 4 (C/Q) of the IO-Link port
- Digital output (DO): binary output signal at pin 4 (C/Q) of the IO-Link port
- IO-Link: IO-Link data transfer via pin 4 (C/Q) of the IO-Link port

The user can set the operating mode separately for each IO-Link port.

To set the operating mode of an IO-Link port:

- ▶ Select [Port x] menu (x = 1...8).
- > The menu page shows the current settings.
- ▶ Set the following parameters as required:

Name	Description	Possible values	
[Mode]	Operating mode of the IO-Link port	[Disabled]	Port deactivated
		[DI]	Operation as digital input
		[DO]	Operation as digital output
		[IO-Link]	Operation as IO-Link interface
[Cycle time actual]**	Current cycle time of the data transfer between IO-Link master and IO-Link device on the port (value in microseconds)	Parameter can only be read	
[Cycle time preset]*	Cycle time of the data transfer between the IO-Link master and the IO-Link device at the port (value in microseconds)	0	The device automatically sets the fastest possible cycle time.
		1	1 microsecond
	
		132800	132800 microseconds
[Bitrate]**	Current transmission rate of the data transfer between the IO-Link master and the IO-Link device on the port	Parameter can only be read	

* ... Parameter only available if [Mode] = [IO-Link]

** ... Parameter only visible if the IO-Link device is connected to the IO-Link port.

- ▶ Save changed values on the device.

9.1.8 IO-Link ports: Set the device validation and data storage

33697

The user can choose how the IO-Link ports are to behave with regard to the device validation and the storage / recovery of parameter data of the connected IO-Link device.

The following options are available:

Option	Validation of the IO-Link device	Storage of the parameter values	Recovery of the parameter values
[No check and clear]	no	no	no
[Type compatible V1.0 device]	yes, test the compatibility with IO-Link standard V1.0	no	no
[Type compatible V1.1 device]	yes, test the compatibility with IO-Link standard V1.1	no	no
[Type compatible V1.1 device with Backup + Restore]	yes, test the compatibility with IO-Link standard V1.1 and identity of design (vendor ID and device ID)	yes, automatic storage of the parameter values; changes of the current parameter values will be stored	yes, recovery of the parameter values when connecting an identical IO-Link device with factory settings
[Type compatible V1.1 device with Restore]	yes, test the compatibility with IO-Link standard V1.1 and identity of design (vendor ID and device ID)	no, there is no automatic storage changes of the current parameter values will not be stored	yes, recovery of the parameter values when connecting an identical IO-Link device with factory settings



The options only apply if the IO-Link port is in the operating mode "IO-Link".

For options [Type compatible V1.1 device with Backup + Restore] and [Type compatible V1.1 device with Restore]: If the vendor ID and device ID are changed in the online mode, the data memory will be deleted and a new backup of the parameter values of the connected IO-Link device will be created in the IO-Link master.

To configure the device validation and the data storage:

- ▶ select [Port x] menu (x = 1...8).
- > The menu page shows the current settings.
- ▶ Set the following parameters as required:

Name	Description	Possible values	
[Validation / Data Storage]	Supported IO-Link standard and behaviour of the IO-Link master when connecting a new IO-Link device at port x (x = 1...8)	[No check and clear]	
		[Type compatible V1.0 device]	
		[Type compatible V1.1 device]	
		[Type compatible V1.1 device with Backup + Restore]	
		[Type compatible V1.1 device with Restore]	
[Vendor ID]	ID of the manufacturer that is to be validated	0...65535	Factory setting: 0# ifm electronic: 310
[Device ID]	ID of the IO-Link device that is to be validated	0...16777215	Factory setting: 0

- ▶ Save changed values on the device.

9.1.9 IO-Link Ports: Set fails-safe values

34329

For the configuration mode "Independent" the user can set fail-safe values for the outputs of IO-Link ports X01...X08. The fail-safe values will be activated in case of an interruption of the EtherNet/IP connection.

To set the fail-safe values:

- ▶ Select [Port x] menu (x = 1...8).
- > The menu page shows the current settings.
- ▶ Set the following parameters as required:

Name	Description	Possible values	
[Fail-safe digital out]*	Fail-safe value of the output for operating mode "Digital Output (DO)"	[Reset]	OFF
		[Old]	old value
		[Set]	ON
[Fail-safe IO-Link]*	Fail-safe value of the output for operating mode "IO-Link"	[Off]	no Fail-safe
		[Reset]	Fail-safe: OFF
		[Old]	Fail-safe: old value
		[Pattern]	Fail-safe: byte pattern

* ... Parameter only changeable, if the connection to the EtherNet/IP controller is closed

- ▶ Save changed values on the device.

9.1.10 Info: Show device information

34065

To read the general information of the ifm IO-Link master:

- ▶ Select [Info] menu.
- > The menu page shows the current settings.

Name	Description	Possible values
[Product code]	Article number of the IO-Link master	AL1222
[Device family]	Device family of the IO-Link master	IO-Link master
[Vendor]	Vendor	ifm electronic gmbh
[SW-Revision]	Firmware of the IO-Link master	
[HW revision]	Hardware version of the IO-Link master	
[Bootloader revision]	Bootloader version of the IO-Link master	
[Serial number]	Serial number	

9.1.11 Firmware: Reset device to factory settings

33838

When the IO-Link master is reset, all parameters are set to the factory settings:

To reset the device to factory settings:

- ▶ Select [Firmware] menu.
- > The menu page shows the current settings.
- ▶ Click on [Factory Reset] to reset the device.
- > LR DEVICE sets the device to the factory settings.

9.1.12 Firmware: Reboot the device

33832

When rebooting the device, all settings are kept.

To restart the AL1222:

- ▶ Select [Firmware] menu.
- > The menu page shows the current settings.
- ▶ Click on [Reboot] to reboot the device.
- > LR DEVICE reboots the ifm IO-Link master.

9.1.13 Configure IO-Link devices

To configure the IO-Link devices connected to the device with the LR DEVICE parameter setting software:

Requirements:

- > IO-Link master is correctly installed and connected to the LR DEVICE parameter setting software.
- > The IO-Link device is correctly connected to the AL1222.
- > Operating mode of the IO-Link port is "IO-Link" (→ **IO-Link ports: Configure operating mode** (→ S. [30](#))).
- > IoT has write access rights to the IO-Link master (→ **IoT: Configure access rights** (→ S. [25](#))).

1 Select IO-Link master

- ▶ Start LR DEVICE.
- ▶ Update IODD file library
OR:
Import IODD file of the IO-Link device manually.
- ▶ Scan network for devices.
- > LR DEVICE detects IO-Link master.

2 Add IO-Link device

- ▶ Under [ONLINE]: Click on the required IO-Link master.
- > LR DEVICE automatically detects the IO-Link devices connected to the IO-Link master (e.g. ifm sensor KG5065).

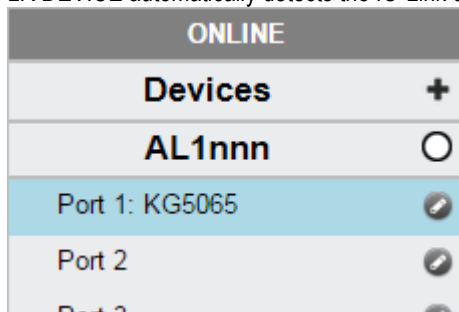

3 Configure IO-Link device

- ▶ Mouse click on the port to which the IO-Link device is connected.
- > LR DEVICE reads and shows the current parameter values of the IO-Link device.
- ▶ Configure IO-Link device.



Information about the available parameters of the IO-Link device: → IO Device Description (IODD) of the IO-Link device

- ▶ Save the changed configuration on the IO-Link device.

9.2 EtherNet/IP

Content

Registration of the EDS file	35
Integrate the AL1222 into the EtherNet/IP project	36
Set connection types and RPI	37
Configure AL1222.....	38
Configure IO-Link ports	39
Configure IO-Link devices	41
Read cyclic input data	42
Write cyclic output data	42
Read diagnostic and status information	43
EtherNet/IP: Programmers' notes.....	44

34391

On the fieldbus side, the device can be configured with any EtherNet/IP compatible projection software.

The information in the following sections refers to the EtherNet/IP projection software RSLogix 5000.

9.2.1 Registration of the EDS file

34324

ifm provides an EDS file to integrate the AL1222 in a EtherNet/IP projection software. The user can download the EDS file from the ifm website (→ www.ifm.com). In the EDS file, all parameters, process data, and their valid value ranges are defined.

To add the AL1222 to the device catalogue of RSLogix5000:

- ▶ Download the EDS file of the AL1222 from the ifm website.
- ▶ Start RSLogix5000.
- ▶ Select [Tools] > [EDS Hardware Installation Tool].
- > EDS Wizard appears.
- ▶ Register the downloaded EDS file of the AL1222 with the EDS Wizard.
- > EDS Wizard installs the EDS file and adds the AL1222 to the device catalogue.

9.2.2 Integrate the AL1222 into the EtherNet/IP project

The device is integrated as module of an I/O scanner in the EtherNet/IP project.

Requirements:

- > The EDS file of the AL1222 is installed (→ **Registration of the EDS file** (→ S. [35](#))).

1 Create/open EtherNet/IP project

- ▶ Start RSLogix 5000.
- ▶ Create new EtherNet/IP project.
OR
Open an existing EtherNet/IP project.

2 Configure EtherNet/IP PLC and IO scanner

- ▶ Select and configure EtherNet/IP controller and IO scanner.
- > EtherNet/IP project includes a EtherNet/IP controller and an IO scanner.

3 Integrate AL1222 in project

- ▶ In the Controller Organizer: Right mouse click on the IO scanner.
- > Context menu appears.
- ▶ In the context menu: Select [New Module...].
- > The window [Select Module Type] appears.
- ▶ Select AL1222 and click on [Create].
- > The [New Module] window appears.
- ▶ Enter name and IP address of the AL1222.
- ▶ Click on [OK] to adopt the entered values.
- > RSLogix 5000 adds AL1222 as sub-element of the IO scanner to the project.

4 Save the project

- ▶ Save EtherNet/IP project

9.2.3 Set connection types and RPI

The IO-Link master supports different connection types (→ **Supported connection types** (→ S. [58](#))). The user can choose which object instances of the input assembly and the output assembly are used. This makes it possible to adapt the size of the transmitted and received data. Additionally the Request Package Interval (RPI) can be selected.

To set the connection type:

Requirements:

- > AL1222 is correctly integrated into the EtherNet/IP project (→ **Integrate the AL1222 into the EtherNet/IP project** (→ S. [36](#))).

1 Open the module properties

- ▶ In the Controller Organizer: Double-click on the IO-Link master node
- > Dialogue window appears.

2 Set connection type

- ▶ Click on [Change...].
- > The [Module Definition] dialogue window appears.
- ▶ Select the required connection type from the list [Connections].
- ▶ Click on [OK] to apply the changes.

3 Change RPI

- ▶ Click on [Connection] tab.
- > The connection settings appear.
- ▶ Select required time value from [RPI] list.
- ▶ Click on [OK] to apply the changes.

9.2.4 Configure AL1222

The AL1222 is configured via the controller tags.

Requirements:

- > AL1222 is correctly integrated in the EtherNet/IP project (→ **Integrate the AL1222 into the EtherNet/IP project** (→ S. 36)).

1 Open controller tags

- ▶ In the Controller Organizer: Double click on [Controller Name_of_Project] > [Controller Tags]
- > [Controller Tags] window appears.
- ▶ In the tree view: Click on [AL1222:C].
- > Controller tags for the configuration of the device appear.

2 Configure AL1222

- ▶ Set the following controller tags as required:

Name	Description	Possible values	
[AL1222:C.Communication_Profile]	The access rights to the parameter data, process data and events/diagnostic messages of the IO-Link master and the connected IO-Link devices	0x00	EtherNet/IP + LineRecorder <ul style="list-style-type: none"> ▪ EtherNet/IP and LR DEVICE have read and write access rights to parameters and process data ▪ EtherNet/IP and LR DEVICE have read access rights to events/alarms
		0x01	EtherNet/IP + LineRecorder (ro) <ul style="list-style-type: none"> ▪ EtherNet/IP has read and write access rights to parameters and process data ▪ EtherNet/IP has read access rights to events/alarms ▪ LR DEVICE only has read access rights to parameters, process data and events/alarms
		0x02	EtherNet/IP only <ul style="list-style-type: none"> ▪ EtherNet/IP has read and write access rights to parameters and process data ▪ EtherNet/IP has read access rights to events/alarms ▪ LR DEVICE has no access rights (parameters, process data, events/alarms, web interface, firmware update)
		0x03	Continue in Use Case previous setting is valid
[AL1222:C.Port_Process_Data_Size]	Length of the process input data and process output data	0x00	2 bytes input, 2 bytes output
		0x01	4 bytes input, 4 bytes output
		0x02	8 bytes input, 8 bytes output
		0x03	16 bytes input, 16 bytes output
		0x04	32 bytes input, 32 bytes output

- ▶ Save EtherNet/IP project

9.2.5 Configure IO-Link ports

The IO-Link ports are configured via the controller tags. The user can configure each IO-Link port separately.

To configure the IO-Link ports:

Requirements:

- > AL1222 is correctly integrated in the EtherNet/IP project (→ **Integrate the AL1222 into the EtherNet/IP project** (→ S. 36)).

1 Open controller tags

- ▶ In the Controller Organizer: Double click on [Controller Name_of_Project] > [Controller Tags]
- > [Controller Tags] window appears.
- ▶ In the tree view: Click on [AL1222:C].
- > Controller tags for the configuration of the device appear.

2 Configure IO-Link ports

- ▶ Configure the following tags for each IO-Link port at will:

Name	Description	Possible values	
[AL1222:C.Port_Mode_Port_x]	Operating mode of the IO-Link port	0x00	Interface deactivated
		0x01	Operation as digital input (DI)
		0x02	Operation as digital output (DO)
		0x03	Operation as IO-Link interface
[AL1222:C.Port_Cycle_Time_Port_x]	Cycle time of the data transmission between the IO-Link master and the IO-Link device	0x00	The device automatically sets the fastest possible cycle time
		0x01	2 milliseconds
		0x02	4 milliseconds
		0x03	8 milliseconds
		0x04	16 milliseconds
		0x05	32 milliseconds
		0x06	64 milliseconds
		0x07	128 milliseconds
[AL1222:C.Swap_Port_x]	Visualisation of the process data (EtherNet/IP uses Little Endian Format (Intel), IO-Link uses Big Endian Format (Motorola))	0x00	Byte swapping for IO-Linkdata deactivated
		0x01	Byte swapping for IO-Linkdata activated
[AL1222:C.Validation_Data_Storage_Port_x]	Supported IO-Link standard and behaviour of the IO-Link master when connecting new IO-Link devices to the IO-Link port	0x00	No validation
		0x01	Type compatible V1.0 device
		0x02	Type compatible V1.1 device
		0x03	Type compatible V1.1 device with Backup + Restore
		0x04	Type compatible V1.1 device with Restore
[AL1222:C.Vendor_ID_Port_x]	Vendor ID of the manufacturer of the device on the IO-Link port	0x0000...0xFFFF ifm electronic: 0x136	
[AL1222:C.Device_ID_Port_x]	Device ID of the device on the IO-Link port	0x000000...0xFFFFFFFF	

Name	Description	Possible values	
[AL1222:C.Fail_Safe_Mode_Port_x]	Fail-safe mode for output data when the EtherNet/IP connection is interrupted	0x00	No Failsafe
		0x01	Failsafe Reset Value
		0x02	Failsafe Old Value
		0x03	Failsafe with Pattern
[AL1222:C.Fail_Safe_Value_DO_Port_x]	Fail-safe value for the operating mode "digital output (DO)"	0x00	Failsafe Reset Value
		0x01	Failsafe Old Value
		0x02	Failsafe Set Value

x = 1...8

- ▶ Save EtherNet/IP project.

9.2.6 Configure IO-Link devices

34359

The AL1222 supports the configuration of the connected IO-Link devices from the EtherNet/IP projection software. For this, ifm offers the EtherNet/IP object "IO-Link Request" (→ **IO-Link requests (object class: 0x80)** (→ S. [95](#))). The object enables direct read and write access to IO-Link objects of the IO-Link device. The extent of the configurable parameters depends on the IO-Link device.

The following services are available:

Name	Description	Reference
Read request	Send a request to read an IO-Link object	→ Read_ISDU (→ S. 96)
Write request	Send a request to write an IO-Link object	→ Write_ISDU (→ S. 99)



Information for the execution of acyclic commands: → **Use acyclic services** (→ S. [45](#))

Available parameters of the IO-Link devices: → Operating instructions of the IO-Link device

9.2.7 Read cyclic input data

34360

The user can access the cyclic input data of the connected sensors and IO-Link devices via the controller tags of the AL1222.



To check the validity of the cyclic process data, evaluate the PQI byte (→ **Mapping: PQI** (→ S. [68](#))).

Even with an interruption of the fieldbus connection the PQI byte indicates that the process data is valid. This can have unintended impact on the control process.

- ▶ Take suitable measures to detect an interruption of the fieldbus connection.

To access the input data:

- ▶ Starting RSLogix5000.
- ▶ Open the EtherNet/IP project.
- ▶ In the project tree: Mouse click on [Controller Tags] > [AL1222.I]
- > The window shows the data structure with cyclic input data ([AL1222.I:Data])



Mapping of the inputs to the data structure [AL1222.I:Data]: → **Cyclic data** (→ S. [63](#))

9.2.8 Write cyclic output data

34386

The user can access the cyclic output data of the connected actuators and IO-Link devices via the controller tags of the AL1222.



To check the validity of the cyclic process data, evaluate the PQI byte (→ **Mapping: PQI** (→ S. [68](#))).

Even with an interruption of the fieldbus connection the PQI byte indicates that the process data is valid. This can have unintended impact on the control process.

- ▶ Take suitable measures to detect an interruption of the fieldbus connection.

To access the cyclic output data:

- ▶ Starting RSLogix5000.
- ▶ Open the EtherNet/IP project.
- ▶ In the project tree: Mouse click on [Controller Tags] > [AL1222.O]
- > The window shows the data structure with cyclic output data ([AL1222.O:Data])



Mapping of the outputs to the data structure [AL1222.C:O]: → **Cyclic data** (→ S. [63](#)).

9.2.9 Read diagnostic and status information

Diagnostic and status information is a part of the cyclically transmitted process data. The input assembly includes the following information:

Byte	Content
2	Indication of short circuit/overload of the IO-Link ports X01...X08
3	Status indication of the voltage supply of the device
43	Port X01: Status information + events
58	Port X02: Status information + events
73	Port X03: Status information + events
88	Port X04: Status information + events
103	Port X05: Status information + events
118	Port X06: Status information + events
133	Port X07: Status information + events
148	Port X08: Status information + events

To access the cyclically transmitted diagnostic and status information:

- ▶ Starting RSLogix5000.
- ▶ Open a EtherNet/IP project.
- ▶ In the project tree: Mouse click on [Controller Tags] > [AL1222.I]
- > The window shows cyclic input data (Input Assembly).
- ▶ Link diagnostic and status information with variables.



Mapping of the diagnostic and status information on the data structure [AL1222.C:I]: → **Cyclic data** (→ S. [63](#)).

9.2.10 EtherNet/IP: Programmers' notes

34400

The programmer can access the following data from the PLC application:

- Read cyclic input and output data of the IO-Link devices
- Read diagnostic and status information
- Change parameters of the IO-Link port of the AL1222
- Read and change parameters of the connected IO-Link devices

The following sections show the available options.

Supported EtherNet/IP configuration modes

34383

The AL1222 supports the following EtherNet/IP configuration modes:

- **Top down**
 - Configuration of the EtherNet/IP slave with the EtherNet/IP projection software (Configuration Assembly)
 - EtherNet/IP plc transmits the created configuration to the EtherNet/IP slave, where it is stored
- **Independent**
 - Configuration of the EtherNet/IP slave with LR DEVICE oder IoT core
 - Configuration Assembly in EtherNet/IP project is not evaluated

Use acyclic services

34381

The AL1222 offers the following options to execute acyclic commands:

Command channels in cyclic process data

34318

Within the cyclic input and output data, special areas are available for the acyclic data transmission. Both read and write access can be implemented via the areas.

Principle of the command channels

34343

General process of an acyclic communication:

1 Write command request

- ▶ In the request channel: write requested command data (without [Trigger] bit)
- ▶ Set [Trigger] = 1.
- > Change of [Trigger] = 1 indicates a new command.
- > In the response channel: all bytes are set to 0.
- > Command processing is started.

2 Check status

- ▶ In the response channel: check [Handshake] bit.
 - If [Handshake] \neq 0: command processing completed, continue with step 3.
 - If [Handshake] == 0: command is processed, repeat step 2.

3 Read command response

- ▶ In the response channel: read responded user data.
- ▶ In the request channel: set [Trigger] = 0.

Acyclic port commands

34336

For the acyclic access to the configuration of the IO-Link ports of the AL1222, the following commands are available:

Command	Description	Reference
Set mode	Set the operating type of the IO-Link port	→ Command 0x10 – Set mode (→ S. 80)
Set Validation ID / Data Storage	Adjust the supported IO-Link standard and the behaviour of the IO-Link master when connecting a new IO-Link device to the IO-Link port	→ Command 0x20 – Set validation ID / data storage (→ S. 82)
Set fail-safe data pattern	Behaviour of the outputs when the EtherNet/IP connection is interrupted and setting of the corresponding fail-safe values	→ Command 0x30 – Set fail-safe data pattern (→ S. 84)

The port commands use the same mechanisms as the acyclic command channel (→ **Acyclic command channel** (→ S. [74](#))).

EtherNet/IP mechanisms for acyclic commands

34404

Acyclic commands can be executed with the EtherNet/IP command Message (MSG).

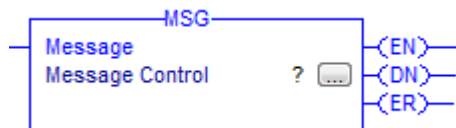

Parameters of the available field bus objects: → **Field bus objects** (→ S. [86](#))

For detailed information about the Message (MSG) command: → Operating instructions RSLogix 5000

10 Maintenance, repair and disposal

Content

Cleaning process	47
Firmware update.....	48
Replace IO-Link device	49

51990

The operation of the unit is maintenance-free.

- ▶ Dispose of the unit in an environmentally friendly way in accordance with the applicable national regulations when it is no longer used.

10.1 Cleaning process

51991

- ▶ Clean the surface of the unit when necessary.
- ▶ Do not use any caustic cleaning agents for this!

10.2 Firmware update

The new firmware is installed via the device's web interface.



If the firmware update is not successful, deactivate all connections to the EtherNet/IP PLC, LR SMARTOBSERVER and LR DEVICE and repeat the process.

- ▶ Close connection to EtherNet/IP PLC.
- ▶ Set the parameter [IP address SmartObserver] to 255.255.255.255 or 0.0.0.0 (→ **IoT: Configure the interface to LR AGENT or LR SMARTOBSERVER** (→ S. 26)).
- ▶ Stop the LRAgent.LRDevice service in the Windows task manager.

After the firmware update check the settings of the LR SMARTOBSERVER interface!

To install a new firmware version on the device:

Requirements

- > File with new firmware has been downloaded.
- > Ethernet connection between laptop/PC and device is established.

1 Call up web interface

- ▶ Start web browser.
- ▶ Enter the following into the address field of the browser and press [ENTER] to confirm:
http://<IP address of the device>/web/update
- > Web browser shows the [Firmware Update] page.

2 Load new firmware to AL1222

- ▶ Click on [Select file].
- > Dialogue window appears.
- ▶ Select the firmware file and click on [Open] in order to adopt the file.
- ▶ Click on [Submit] to start the firmware update.
- > Firmware is being loaded to the device.
- > After successful storage, the success message is displayed

3 Restart the device

- ▶ Click on [Restart device now] to restart the device.
- > The status LED RDY flashes quickly.
- > Firmware is updating.
- ▶ Follow the instructions in the browser.

10.3 Replace IO-Link device

34182

To replace an IO-Link device:

Requirement:

- > IO-Link device is with factory settings.
- > IO-Link device supports IO-Link standard 1.1 or higher.

1 Set data storage

- ▶ Set the following parameters of the IO-Link port:
Validation and Data Storage = [Type compatible V1.1 device with Restore]
- ▶ Save changes.

2 Replace IO-Link device

- ▶ Disconnect old IO-Link device from IO-Link master.
- ▶ Connect new IO-Link device with the same IO-Link port of the AL1222.
- > IO-Link master copies parameter values from the data memory to the new IO-Link device.

11 Factory Settings

34591

In the factory settings, the device has the following parameter settings:

Parameter	Factory setting
[IP address]	192.168.1.250
[Subnet mask]	255.255.255.0
[IP gateway address]	0.0.0.0
[Host name]	blank
Data Storage	empty

12 Accessories

33870

List of accessories of AL1222: → www.ifm.com > Product page > Accessories

13 Appendix

Content

Technical data	53
EtherNet/IP	58

33879

13.1 Technical data

Content

Application	53
Electrical data	53
Inputs / outputs	55
Inputs	55
Outputs	55
Interfaces	55
Operating conditions	56
Mechanical data	56
Approvals / tests	56
Electrical connection	57

34188

13.1.1 Application

33878

Application	
Application	I/O modules for field applications
Daisy-chain function	Voltage supply; Fieldbus interface

13.1.2 Electrical data

34574

Electrical data	
Operating voltage [V]	20...30 DC; (US; according to SELV/PELV)
Current consumption [mA]	300...3900; (US)
Protection class	III
Additional voltage supply [V]	20...30 DC; (UA)
Sensor supply US	
Max. current load total [A]	3.6
Actuator supply UA	
Max. current load total [A]	3.6

Derating characteristics

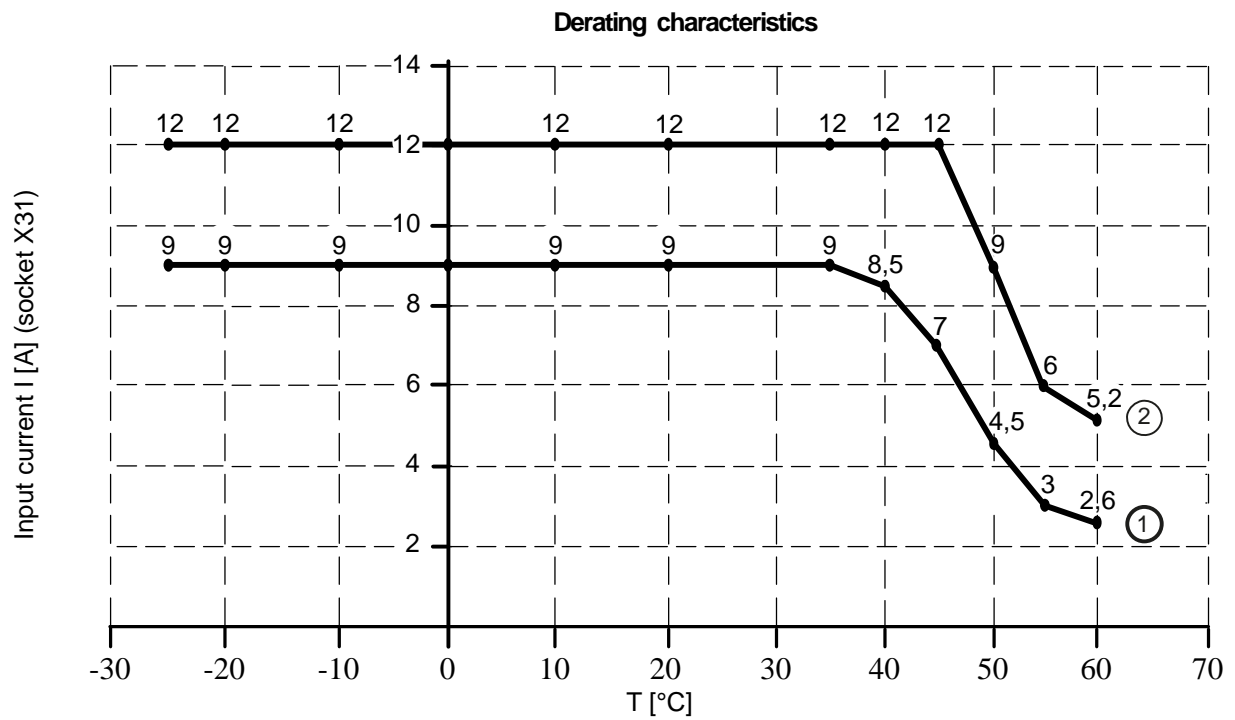

- ① Max. single input current [A] (from each U_s / U_A) if $I_s \leq 9A$ and $I_A \leq 9A$
- ② Max. total input current [A] (from sum $U_s + U_A$) if $I_s > 9A$ or $I_A > 9A$

e.g.:

I_s [A]	I_A [A]	curve
9	9	①
12	0	②
10	2	②
5	7	①

13.1.3 Inputs / outputs

34068

Inputs / outputs	
Total number of inputs and outputs	12; (configurable)
Number of Inputs and Outputs	Number of digital inputs: 12; Number of digital outputs: 8

13.1.4 Inputs

34069

Inputs	
Number of digital inputs	12; (IO-Link Port Class A: 4 x 2; IO-Link Port Class B: 4 x 1)
Switching level high [V]	11...30
Switching level low [V]	0...5
Digital inputs protected against short circuits	yes

13.1.5 Outputs

34053

Outputs	
Number of digital outputs	8; (IO-Link Port Class A: 4 x 1; IO-Link Port Class B: 4 x 1)
Max. current load per output [mA]	300
Short-circuit protection	yes

13.1.6 Interfaces

34584

Interfaces	
Communication interface	Ethernet; IO-Link
Communication interface	IO-Link; TCP/IP; EtherNet/IP
Ethernet	
Transmission standard	10Base-T; 100Base-TX
Transmission rate [MBit/s]	10; 100
Protocol	TCP/IP; EtherNet/IP
Factory settings	<ul style="list-style-type: none"> ▪ IP address: 192.168.1.250 ▪ Subnet mask: 255.255.255.0 ▪ Gateway IP address: 0.0.0.0 ▪ MAC address: see type label
IO-Link Master	
Transmission type	COM 1 / COM 2 / COM 3
IO-Link revision	V1.1
Number of ports class A	4
Number of ports class B	4

13.1.7 Operating conditions

34062

Operating conditions	
Applications	Indoor use
Ambient temperature [°C]	-25...60
Storage temperature [°C]	-25...85
Max. perm. relative air humidity [%]	90
Max. height above sea level [m]	2000
Protection rating	IP 65; IP 66; IP 67
Pollution Degree	2

13.1.8 Mechanical data

34050

Mechanical data	
Weight [g]	407
Materials	Housing: PA; socket: brass nickel-plated

13.1.9 Approvals / tests

34577

Approval / tests	
EMC	<ul style="list-style-type: none"> ▪ EN 61000-6-2 ▪ EN 61000-6-4
MTTF [Years]	64

13.1.10 Electrical connection

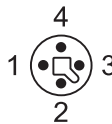
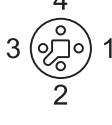
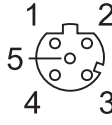
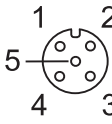
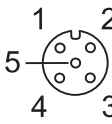
Voltage supply IN X31		
Connector	M12	
Wiring		1: + 24 V DC (US) 2: GND (UA) 3: GND (US) 4: +24 V DC (UA)
Voltage supply OUT X32		
Connector	M12	
Wiring		1: + 24 V DC (US) 2: GND (UA) 3: GND (US) 4: +24 V DC (UA)
Ethernet IN / OUT X21, X22		
Connector	M12	
Wiring		1: TX + 2: RX + 3: TX - 4: RX - 5: -
Process connection IO-Link Ports Class A X01...X04		
Connector	M12	
Wiring		1: Sensor supply (US) L+ 2: DI 3: Sensor supply (US) L- 4: C/Q IO-Link 5: -
Process connection IO-Link Ports Class B X05...X08		
Connector	M12	
Wiring		1: Sensor supply (US) L+ 2: Actuator supply (UA) L+ 3: Sensor supply (US) L- 4: C/Q IO-Link 5: Actuator supply (UA) L-

13.2 EtherNet/IP

Content

Supported connection types	58
Parameter data	59
Cyclic data	63
Acyclic data	74

33674

13.2.1 Supported connection types

34410

Name	Configuration Assembly	Input Assembly - Instance	Output Assembly - Instance
Exclusive Owner IO-Acyc-Diag	199	100	150
Exclusive Owner IO-Acyc	199	101	150
Exclusive Owner IO	199	102	151
Input only	199	100	193 (empty)
Listen only	199	100	192 (empty)

13.2.2 Parameter data

Content

Configuration Assembly (Instance 199)	60
---	----

34170

Configuration Assembly (Instance 199)

34358



The values of the Configuration Assembly are set in RSLogix 5000 via the controller tags of the EtherNet/IP project.

Bytes	Contents
0	Access Rights
1	Process Data Length
2...13	Port X01: Port configuration (→ Mapping: Port configuration (→ S. 61))
14...25	Port X02: Port configuration (→ Mapping: Port configuration (→ S. 61))
26...37	Port X03: Port configuration (→ Mapping: Port configuration (→ S. 61))
38...49	Port X04: Port configuration (→ Mapping: Port configuration (→ S. 61))
50...61	Port X05: Port configuration (→ Mapping: Port configuration (→ S. 61))
62...73	Port X06: Port configuration (→ Mapping: Port configuration (→ S. 61))
74...85	Port X07: Port configuration (→ Mapping: Port configuration (→ S. 61))
86...97	Port X08: Port configuration (→ Mapping: Port configuration (→ S. 61))

Legend:

- [Access Rights] Access rights to parameter, process data and events / diagnostics data of the IO-Link master and the connected IO-Link devices

1 Byte	0x00	EtherNet/IP + IoT
	0x01	EtherNet/IP + IoT (ro)
	0x02	EtherNet/IP only
	0x03	Keep setting (default)

- [Process Data Length] Length of the process input data and process output data

1 Byte	0x00	2 Bytes Input / 2 Bytes Output Data <ul style="list-style-type: none"> ▪ Input Assembly: 206 Bytes ▪ Output Assembly: 62 Bytes
	0x01	4 Bytes Input / 4 Bytes Output Data <ul style="list-style-type: none"> ▪ Input Assembly: 222 Bytes ▪ Output Assembly: 78 Bytes
	0x02	8 Bytes Input / 8 Bytes Output Data <ul style="list-style-type: none"> ▪ Input Assembly: 254 Bytes ▪ Output Assembly: 110 Bytes
	0x03	16 Bytes Input / 16 Bytes Output Data <ul style="list-style-type: none"> ▪ Input Assembly: 318 Bytes ▪ Output Assembly: 174 Bytes
	0x04	32 Bytes Input / 32 Bytes Output Data <ul style="list-style-type: none"> ▪ Input Assembly: 446 Bytes ▪ Output Assembly: 302 Bytes

Mapping: Port configuration

Byte
Port Mode
Master Cycle Time
Byte Swap
Validation ID
Vendor ID (MSB)
Vendor ID (LSB)
Device ID (MSB)
Device ID
Device ID (LSB)
reserved
Failsafe Mode -- IO-Link
Failsafe Mode -- pin 4 (DO)

Legend:

▪ [Port Mode]	Operating mode of the IO-Link port	1 byte	0x00	Interface deactivated
			0x01	Operation as digital input (DI)
			0x02	Operation as digital output (D=)
			0x03	Operation as IO-Link port
▪ [Master Cycle Time]	Cycle time of the data transmission between the IO-Link master and the IO-Link device	1 byte	0x00	As fast as possible
			0x01	2 milliseconds
			0x02	4 milliseconds
			0x03	8 milliseconds
			0x04	16 milliseconds
			0x05	32 milliseconds
			0x06	64 milliseconds
			0x07	128 milliseconds
▪ [Byte Swap]	Visualisation of the process data (EtherNet/IP uses Little Endian Format (Intel), IO-Link uses Big Endian Format (Motorola))	1 byte	0x00	Byte swapping for IO-Link process data deactivated
			0x01	Byte swapping for IO-Link process data activated
▪ [Validation ID]	Supported IO-Link standard and behaviour of the IO-Link master when connecting new IO-Link devices to the IO-Link port	1 byte	0x00	No validation
			0x01	V1.0 device
			0x02	V1.1 device
			0x03	V1.1 device with Backup + Restore
			0x04	V1.1 device with Backup

<ul style="list-style-type: none"> ▪ [Vendor ID] 	<p>Vendor ID of the manufacturer of the device on the IO-Link port Vendor ID = 0x1234</p> <ul style="list-style-type: none"> ▪ Vendor ID (MSB) = 0x12 ▪ Vendor ID (LSB) = 0x34 	2 Bytes	pro Byte: 0x00...0xFF		
<ul style="list-style-type: none"> ▪ [Device ID] 	<p>Device ID of the device on the IO-Link port Device ID = 0x123456</p> <ul style="list-style-type: none"> ▪ Device ID (MSB) = 0x12 ▪ Device ID = 0x34 ▪ Device ID (LSB) = 0x56 	3 bytes	pro Byte: 0x00...0xFF		
<ul style="list-style-type: none"> ▪ [Failsafe Mode -- IO-Link] 	<p>Fail-safe mode for output data when the EtherNet/IP connection is interrupted</p>	1 byte	0x00	No Failsafe	
			0x01	Failsafe Reset Value	
			0x02	Failsafe Old Value	
			0x03	Failsafe with Pattern	
<ul style="list-style-type: none"> ▪ [Failsafe Mode -- pin 4 (DO)] 	<p>Fail-safe value for the operating mode "digital output (DO)"</p>	1 byte	0x00	Failsafe Reset Value	
			0x01	Failsafe Old Value	
			0x02	Failsafe Set Value	

13.2.3 Cyclic data

Content

Input assembly (Instance 100): I/O data + acyclic data + diagnosis data	64
Input Assembly (Instance 101): I/O data + acyclic data	65
Input Assembly (Instance 102): I/O data	66
Output assembly (Instance 150): I/O data + acyclic data	71
Output Assembly (Instance 151): I/O data	72

33814

Input assembly (Instance 100): I/O data + acyclic data + diagnosis data

Byte	Content
0...1	Port X01...X08: Digital input - pin 2 / 4 (DI) (→ Mapping: digital input data (DI) (→ S. 67))
2...3	Status information (→ Mapping: Status information (→ S. 67))
4...45	Acyclic command area: Response channel (→ Response channel (→ S. 76))
46...47	Port X01: PQI (→ Mapping: PQI (→ S. 68))
48...63	Port X01: Diagnostic, vendor ID, device ID, events (→ Mapping: IO-Link port information (→ S. 69))
64...65	Port X02: PQI (→ Mapping: PQI (→ S. 68))
66...81	Port X02: Diagnostic, vendor ID, device ID, results (→ Mapping: IO-Link port information (→ S. 69))
82...83	Port X03: PQI (→ Mapping: PQI (→ S. 68))
84...99	Port X03: Diagnostic, vendor ID, device ID, events (→ Mapping: IO-Link port information (→ S. 69))
100...101	Port X04: PQI (→ Mapping: PQI (→ S. 68))
102...117	Port X04: Diagnostic, vendor ID, device ID, events (→ Mapping: IO-Link port information (→ S. 69))
118...119	Port X05: PQI (→ Mapping: PQI (→ S. 68))
120...135	Port X05: Diagnostic, vendor ID, device ID, events (→ Mapping: IO-Link port information (→ S. 69))
136...137	Port X06: PQI (→ Mapping: PQI (→ S. 68))
138...153	Port X06: Diagnostic, vendor ID, device ID, events (→ Mapping: IO-Link port information (→ S. 69))
154...155	Port X07: PQI (→ Mapping: PQI (→ S. 68))
156...171	Port X07: Diagnostic, vendor ID, device ID, events (→ Mapping: IO-Link port information (→ S. 69))
172...173	Port X08: PQI (→ Mapping: PQI (→ S. 68))
174...189	Port X08: Diagnostic, vendor ID, device ID, events (→ Mapping: IO-Link port information (→ S. 69))
190	Port X01: Input data IO-Link (n bytes)
190+n	Port X02: Input data IO-Link (n bytes)
190+2n	Port X03: Input data IO-Link (n bytes)
190+3n	Port X04: Input data IO-Link (n bytes)
190+4n	Port X05: Input data IO-Link (n bytes)
190+5n	Port X06: Input data IO-Link (n bytes)
190+6n	Port X07: Input data IO-Link (n bytes)
190+7n	Port X08: Input data IO-Link (n bytes)

Legend:

n = [2,4,8,16,32]; is determined by the parameter [Prozess_Data_Length] (→ **Configuration Assembly (Instance 199)** (→ S. 60))

Input Assembly (Instance 101): I/O data + acyclic data

Byte	Content
0...1	Port X01...X08: Digital Input pin 2 / 4 (DI) (→ Mapping: digital input data (DI) (→ S. 67))
2...3	Status information (→ Mapping: Status information (→ S. 67))
4...45	Acyclic commando area: Response channel (→ Response channel (→ S. 76))
46...47	Port X01: Pqi (→ Mapping: Pqi (→ S. 68))
48...49	Port X02: Pqi (→ Mapping: Pqi (→ S. 68))
50...51	Port X03: Pqi (→ Mapping: Pqi (→ S. 68))
52...53	Port X04: Pqi (→ Mapping: Pqi (→ S. 68))
54...55	Port X05: Pqi (→ Mapping: Pqi (→ S. 68))
56...57	Port X06: Pqi (→ Mapping: Pqi (→ S. 68))
58...59	Port X07: Pqi (→ Mapping: Pqi (→ S. 68))
60...61	Port X08: Pqi (→ Mapping: Pqi (→ S. 68))
62	Port X01: Input data IO-Link (n bytes)
62+n	Port X02: Input data IO-Link (n bytes)
62+2n	Port X03: Input data IO-Link (n bytes)
62+3n	Port X04: Input data IO-Link (n bytes)
62+4n	Port X05: Input data IO-Link (n bytes)
62+5n	Port X06: Input data IO-Link (n bytes)
62+6n	Port X07: Input data IO-Link (n bytes)
62+7n	Port X08: Input data IO-Link (n bytes)

Legend:

n = [2,4,8,16,32]; is determined by the parameter [Process Data Length] (→ **Configuration Assembly (Instance 199)** (→ S. [60](#)))

Input Assembly (Instance 102): I/O data

Byte	Content
0...1	Digital inputs of the IO-Link ports in DI operating mode (→ Mapping: digital input data (DI) (→ S. 67))
2...3	Status information (→ Mapping: Status information (→ S. 67))
4...5	Port X01: PQI (→ Mapping: PQI (→ S. 68))
6...7	Port X02: PQI (→ Mapping: PQI (→ S. 68))
8...9	Port X03: PQI (→ Mapping: PQI (→ S. 68))
10...11	Port X04: PQI (→ Mapping: PQI (→ S. 68))
12...13	Port X05: PQI (→ Mapping: PQI (→ S. 68))
14...15	Port X06: PQI (→ Mapping: PQI (→ S. 68))
16...17	Port X07: PQI (→ Mapping: PQI (→ S. 68))
18...19	Port X08: PQI (→ Mapping: PQI (→ S. 68))
20	Port X01: Cyclic input data (n bytes)
20+n	Port X02: Cyclic input data (n bytes)
20+2n	Port X03: Cyclic input data (n bytes)
20+3n	Port X04: Cyclic input data (n bytes)
20+4n	Port X05: Cyclic input data (n bytes)
20+5n	Port X06: Cyclic input data (n bytes)
20+6n	Port X07: Cyclic input data (n bytes)
20+7n	Port X08: cyclic input data (n bytes)

Legend:

n = [2,4,8,16,32]; is determined by the parameter [Process Data Length] (→ **Configuration Assembly (Instance 199)** (→ S. [60](#)))

Mapping: PQI

Bit 7	Bit 6	Bit 5	Bit 4	Bit 3	Bit 2	Bit 1	Bit 0
Diagnosis present	Wrong PD Output Length	Wrong PD Input Length	Wrong Cycle Time	Wrong VID / DID	Invalid Data Bit	Dev Not Conn	IOL Mode
reserved							

Legend:

▪ [IOL Mode]	Operating mode of the IO-Link port	1 bit	0x0	not IO-Link
			0x1	IO-Link
▪ [Dev Not Conn]	Connection between IO-Link Device and IO-Link port	1 bit	0x0	connected
			0x1	not connected
▪ [Invalid Data]	Status of the process input data on the IO-Link port	1 bit	0x0	valid Data
			0x1	invalid Data
▪ [Wrong VID/DID]	Evaluation, whether actual and projected Vendor ID and Device ID match	1 bit	0x0	OK
			0x1	wrong VID and/or DID
▪ [Wrong Cycle Time]	Evaluation, whether actual and projected cycle time match	1 bit	0x0	OK
			0x1	wrong cycle time
▪ [Wrong PD Input Length]	Evaluation, whether actual and projected input process data length match	1 bit	0x0	OK
			0x1	projected length too small
▪ [Wrong PD Output Length]	Evaluation, whether actual and projected output process data length match	1 bit	0x0	OK
			0x1	projected length too small
▪ [Diagnosis present]	Signals a new diagnosis event (Coming Event, Single Shot Event)	1 Bit	0x0	no event
	▪ Coming Events are removed when if the related Disappearing Event appears		0x1	New event present
	▪ Single Shot Events are removed automatically			

Mapping: IO-Link port information

Bit 7	Bit 6	Bit 5	Bit 4	Bit 3	Bit 2	Bit 1	Bit 0
VID (LSB)							
VID (MSB)							
DID (LSB)							
DID							
DID (MSB)							
reserved							
Event 1: Mode		Event 1: Type		Event 1: Src		Event 1: Instance	
Event 1: Code (LSB)							
Event 1: Code (MSB)							
Event 2: Mode		Event 2: Type		Event 2: Src		Event 2: Instance	
Event 2: Code (LSB)							
Event 2: Code (MSB)							
Event 3: Mode		Event 3: Type		Event 3: Src		Event 3: Instance	
Event 3: Code (LSB)							
Event 3: Code (MSB)							
reserved							

Legend:

- [VID] Vendor ID of the connected IO-Link device 2 bytes pro Byte: 0x00...0xFF
VID = 0x1234
 - DID (MSB) = 0x12
 - DID (LSB) = 0x34
- [DID] Device ID of the connected IO-Link device 3 bytes pro Byte: 0x00...0xFF
DID = 0x123456
 - DID (MSB) = 0x12
 - DID = 0x34
 - DID (LSB) = 0x56
- [Event m: Mode] Mode: Events mode 2 bits

0x0	reserved
0x1	Single-shot event
0x2	disappearing event
0x3	appearing event
- [Event m: Type] Type: Event category 2 bits

0x0	reserved
0x1	Notification
0x2	Warning
0x3	Error
- [Event m: Src] Source: Events source 1 bit

0x0	IO-Link Device
0x1	IO-Link Master
- [Event m: Instance] Type: Event instance 3 bits

0x0	Unknown
0x1...	reserved
0x3	
0x4	Application

Output assembly (Instance 150): I/O data + acyclic data

34370

Byte	Content
0	Port X01...X08: Digital output - pin 4 (DO) (→ Mapping: Digital output data (DO) (→ S. 73))
1	reserved
2	reserved
3	reserved
4...45	Acyclic command area: Request channel (→ Request channel (→ S. 75))
46	Port X01: Output data IO-Link (n bytes)
46+n	Port X02: Output data IO-Link (n bytes)
46+2n	Port X03: Output data IO-Link (n bytes)
46+3n	Port X04: Output data IO-Link (n bytes)
46+4n	Port X05: Output data IO-Link (n bytes)
46+5n	Port X06: Output data IO-Link (n bytes)
46+6n	Port X07: Output data IO-Link (n bytes)
46+7n	Port X08: Output data IO-Link (n bytes)

Legend:

n = [2,4,8,16,32]; is determined by the parameter [Process_Data_Length] (→ **Configuration Assembly (Instance 199)** (→ S. [60](#)))

Output Assembly (Instance 151): I/O data

34341

Byte	Content
0	Port X01...X08: Digital output - pin 4 (DO) (→ Mapping: Digital output data (DO) (→ S. 73))
1	reserved
2	Port X01: Output data IO-Link (n bytes)
2+n	Port X02: Output data IO-Link (n bytes)
2+2n	Port X03: Output data IO-Link (n bytes)
2+3n	Port X04: Output data IO-Link (n bytes)
2+4n	Port X05: Output data IO-Link (n bytes)
2+5n	Port X06: Output data IO-Link (n bytes)
2+6n	Port X07: Output data IO-Link (n bytes)
2+7n	Port X08: Output data IO-Link (n bytes)

Legend:

n = [2,4,8,16,32]; is determined by the parameter [Process_Data_Length] (→ **Configuration Assembly (Instance 199)** (→ S. [60](#)))

13.2.4 Acyclic data

Content

Acyclic command channel.....	74
Acyclic commands.....	79
Field bus objects.....	86

33868

Acyclic command channel

34325

In the cyclic process data, command channels for the transmission of acyclic data is available.

Object	Contents	Bytes	Access
Output assembly	Request channel (field bus PLC >>> IO-Link master) → Request channel (→ S. 75)	4...45	r/w
Input assembly	Response channel (IO-Link master >>> fieldbus PLC) → Response channel (→ S. 76)	4...45	r

Legend:

r = only read access rights
r/w = read and write access rights

Response channel

Byte	Contents	
4	Port No. (LSB)	
5	Port No. (MSB)	
6	Index (LSB)	
7	Index (MSB)	
8	Sub-index (LSB)	
9	Sub-index (MSB)	
10	Handshake	Command ID
11	Result	
12	Length of response data (number of bytes)	
13	Data (byte 0) or Error Code	
14	Data (byte 1) or Additional Code	
...	...	
44	Data (byte 31)	
45	reserved	

Legend:

- | | | | | |
|--------------|---|--------|------|----------|
| ▪ [Port No.] | Number of the IO-Link port
Port No. = 0x1234 | 8 bits | 0x01 | Port X01 |
| | ▪ Port No. (MSB) = 0x12 | | 0x02 | Port X02 |
| | ▪ Port No. (LSB) = 0x34 | | ... | |
| | | | 0x08 | Port X08 |
- | | | | | |
|-----------|---|--------|-------------------|------|
| ▪ [Index] | Index of the IO-Link object
Index = 0x1234 | 8 bits | per byte: 0x00... | 0xFF |
| | ▪ Index (MSB) = 0x12 | | | |
| | ▪ Index (LSB) = 0x34 | | | |
- | | | | | |
|--------------|---|--------|-------------------|------|
| ▪ [Subindex] | Subindex of the IO-Link object
Subindex = 0x1234 | 8 bits | per byte: 0x00... | 0xFF |
| | ▪ Subindex (MSB) = 0x12 | | | |
| | ▪ Subindex (LSB) = 0x34 | | | |
- | | | | | |
|---------------|---------------------------------------|-------|-----|--------------|
| ▪ [Handshake] | Validity of the IO-Link response data | 1 bit | 0x0 | Data invalid |
| | | | 0x1 | Data valid |
- | | | | | |
|----------------|----------------|--------|------|-------|
| ▪ [Command ID] | Command number | 7 bits | 0x01 | Read |
| | | | 0x02 | Write |
- | | | | | |
|------------|----------------------------------|--------|------|-------------------------|
| ▪ [Result] | Status of the command processing | 8 bits | 0x00 | OK |
| | | | 0x0F | OK, data read >32 bytes |
| | | | 0xFF | Error occurred |
- | | | | | |
|---|---|--------|------|----------|
| ▪ [Length of response data (number of bytes)] | Number of bytes that contain relevant user data | 8 bits | 0x00 | 0 bytes |
| | | | ... | |
| | | | 0x20 | 32 bytes |

- [Data (byte 0) or Error Code] User data (byte 0) or error codes 8 bits User data: 0x00...0xFF
Error Code: → **Error codes** (→ S. [78](#))
- [Data (byte 1) or Additional Code] User data (byte1) or additional error codes 8 bits User data: 0x00...0xFF
Additional Code: → **Additional Codes**
(→ S. [78](#))
- [Data (byte n)] User data (byte n) 8 bits 0x00...0xFF

Error codes

34342

Error code	Description
0x71	Service not available (unknown command has been sent to the IO-Link port)
0x72	Port blocked (another cyclic process accesses the IO-Link port)
0x73	Forbidden (access rights don't allow command processing)
0x74	Invalid data (wrong parameter has been sent in the command)
0x76	Wrong port (wrong port number)
0x77	Wrong port function (wrong port function or wrong parameter has been sent to the device)
0x78	Invalid length (set length is > 0x20)
0x80	Error in the device application; observe additional code (→ Additional Codes (→ S. 78))

Additional Codes

54584

Code	Name	Description
0x00	APP_DEV	Device application error - no details
0x11	IDX_NOTAVAIL	Index not available
0x12	SUBIDX_NOTAVAIL	Subindex not available
0x20	SERV_NOTAVAIL	Service temporarily not available
0x21	SERV_NOTAVAIL_LOCTRL	Service temporarily not available - local control
0x22	SERV_NOTAVAIL_DEVCTRL	Service temporarily not available - device control
0x23	IDX_NOT_WRITEABLE	Access denied
0x30	PAR_VALOUTOFRNG	Parameter value out of range
0x31	PAR_VALGLTIM	Parameter value above limit
0x32	PAR_VALLTLIM	Parameter value below limit
0x33	VAL_LENORRUN	Parameter length overrun
0x34	VAL_LENUNDRUN	Parameter length underrun
0x35	FUNC_NOTAVAIL	Function not available
0x36	FUNC_UNAVAILTEMP	Function temporarily not available
0x40	PAR_SETINVALID	Invalid parameter set
0x41	PAR_SETINCONSIST	Inconsistent parameter set
0x82	APP_DEVNOTRDY	Application not ready



Additional Codes are only available, if Error Code = 0x80 (→ **Error codes** (→ S. 78))

Acyclic commands

Content	
Command 0x10 – Set mode.....	80
Command 0x20 – Set validation ID / data storage.....	82
Command 0x30 – Set fail-safe data pattern.....	84

34331

Field bus objects

Content

CIP class services	86
CIP object classes	87
Identity Object (object class: 0x01)	88
Message Router Object (object class: 0x02).....	90
Assembly Object (object class: 0x04)	91
Connection Manager Object (object class: 0x06)	92
Device Level Ring Object (object class: 0x47)	93
Quality of Service (object class: 0x48)	94
IO-Link requests (object class: 0x80)	95
TCP/IP object (object class: 0xF5)	105
Ethernet Link Object (object class: 0xF6).....	107

34352

CIP class services

34335

The device supports the following class and instance services:

Class code		Service	Description
dec	hex		
01	01	Get Attribute All	Read all attribute values of the class or instance
02	02	Set Attribute All	Change all attribute values of the class or instance
05	05	Reset	Reset
09	09	Delete	Delete
14	0E	Get Attribute Single	Read single attribute value of the class or instance
16	10	Set Attribute Single	Change single attribute value of the class or instance
75	4B	Read ISDU	Read ISDU
76	4C	Write ISDU	Write ISDU
77	4D	Write Failsafe Pattern	Write failsafe pattern
78	4E	Forward Close	Close connection
84	54	Forward Open	Open new connection

CIP object classes

34334

The device supports the following CIP object classes:

Class code		Object type	Reference
dec	hex		
01	01	Identity Object	→ Identity Object (object class: 0x01) (→ S. 88)
02	02	Message Router Object	→ Message Router Object (object class: 0x02) (→ S. 90)
04	04	Assembly Object	→ Assembly Object (object class: 0x04) (→ S. 91)
06	06	Connection Manager Object	→ Connection Manager Object (object class: 0x06) (→ S. 92)
71	47	Device Level Ring Object	→ Device Level Ring Object (object class: 0x47) (→ S. 93)
72	48	Quality of Service	→ Quality of Service (object class: 0x48) (→ S. 94)
128	80	IO-Link Requests	→ IO-Link requests (object class: 0x80) (→ S. 95)
245	F5	TCP/IP Object	→ TCP/IP object (object class: 0xF5) (→ S. 105)
246	F6	Ethernet Link Object	→ Ethernet Link Object (object class: 0xF6) (→ S. 107)

Identity Object (object class: 0x01)

34340

The Identity Object contains the general information about the device.

Class attributes

34310

Attr. ID	Access	Name	Data type	Description	Value
1	Get	Revision	UINT	Revision of the object	1
2	Get	Max instance	UINT	Max. number of instances of the object	1
6	Get	Maximum ID Number Class Attributes	UINT	ID of the last class attribute	7
7	Get	Maximum ID Number Instance Attributes	UINT	ID of the last instance attribute	9

Instance attributes

34339

Attr. ID	Access	Name	Data type	Description	Preset	
1	Get	Vendor ID	UINT	Manufacturer ID	322	
2	Get	Device type	UINT	Type of unit	12	
3	Get	Product code	UINT	Identification of a particular product of a vendor	1323	
4	Get	Revision	STRUCT	Revision of the article that is represented by the Identity Object	1.1	
		▪ Major revision	USINT	Main revision (1...127)	1	
		▪ Minor revision	USINT	Side revision (3 digits, if necessary with zeros in the beginning)	1	
5	Get	Status	WORD	Status of the device		
6	Get	Serial number	UDINT	Serial number of the device		
7	Get	Product Name	SHORT STRING	Readable device designation (max. 32 ASCII characters)	IO-Link Master DL EIP 8P IP69K	
8	Get	State	USINT	Current status of the device (according to status transition diagram)		
				0		Nonexistent
				1		Device Self Testing
				2		Standby
				3		Operational
				4		Major Recoverable Fault
				5		Major Unrecoverable Fault
				6...254		Reserved
255	Default for Get_Attributes_All service					
9	Get	Configuration Consistency Value	UINT	The content shows the configuration of the device	0	

Supported services

34377

Service code		Name	Class	Attribute	Description
dec	hex				
01	01	Get_Attribute_All	yes	yes	Read all attributes
05	05	Reset	yes	yes	Reset
14	0E	Get_Attribute_Single	yes	yes	Read single attribute
16	10	Set_Attribute_Single	yes	yes	Change single attribute

If an Identity Object receives a reset request, it carries out the following actions:

- It checks if it supports the requested reset type.
- It responds to the request.
- It tries to execute the requested reset type.

Supported reset types:

- 0 Reboot the device (obligatory for all EtherNet/IP devices).
- 1 Restore factory settings and reboot the device.

Message Router Object (object class: 0x02)

34390

The Message Router Object provides an access with which an EtherNet/IP client can address a service to any object class or instance in the physical device.

Class attributes

34320

Attr. ID	Access	Name	Data type	Description	Value
1	Get	Revision	UINT	Revision of the object	1
2	Get	Max instance	UINT	Max. number of instances of the object	1
3	Get	Number of Instances	UINT	Number of instances	1
6	Get	Maximum ID Number Class Attributes	UINT	ID of the last class attribute	7
7	Get	Maximum ID Number Instance Attributes	UINT	ID of the last instance attribute	0

Instance attributes

34402

The object has no instance attributes.

Supported services

34374

Service code		Name	Class	Attribute	Description
dec	hex				
14	0E	Get_Attribute_Single	yes	no	Read single attribute value

Assembly Object (object class: 0x04)

34332

The Assembly Object combines attributes of several objects to allow data to be sent to or received from each object via one connection.

Class attributes

34309

Attr. ID	Access	Name	Data type	Description	Value
1	Get	Revision	UINT	Revision of the object	2
2	Get	Max instance	UINT	Max. number of instances of the object	0x00C7
3	Get	Number of Instances	UINT	Number of instances	3
6	Get	Maximum ID Number Class Attributes	UINT	ID of the last class attribute	7
7	Get	Maximum ID Number Instance Attributes	UINT	ID of the last instance attribute	4

Instance attributes

34403

Attr. ID	Access	Name	Data type	Description	Preset
100	Get	Input assembly	STRUCT	Cyclic input data (→ Input assembly (Instance 100): I/O data + acyclic data + diagnosis data (→ S. 64))	--
101	Get	Input assembly	STRUCT	Cyclic input data (→ Input Assembly (Instance 101): I/O data + acyclic data (→ S. 65))	--
102	Get	Input assembly	STRUCT	Cyclic input data (→ Input Assembly (Instance 102): I/O data (→ S. 66))	--
150	Get, Set	Output assembly	STRUCT	Cyclic output data (→ Output assembly (Instance 150): I/O data + acyclic data (→ S. 71))	--
151	Get, Set	Output assembly	STRUCT	Cyclic output data (→ Output Assembly (Instance 151): I/O data (→ S. 72))	--
199	Get, Set	Configuration assembly	STRUCT	Configuration data (→ Configuration Assembly (Instance 199) (→ S. 60))	--

Supported services

34376

Service code		Name	Class	Attribute	Description
dec	hex				
14	0E	Get_Attribute_Single	yes	yes	Read attribute value
16	10	Set_Attribute_Single	no	yes	Change attribute value

Connection Manager Object (object class: 0x06)

34367

The Connection Manager Object structures and manages the internal resources that are used for the connection.

Class attributes

34319

Attr ID	Access	Name	Data type	Description	Value
1	Get	Revision	UINT	Revision of the object	1
2	Get	Max instance	UINT	Max. number of instances of the object	1
3	Get	Number of Instances	UINT	Number of instances	3
6	Get	Maximum ID Number Class Attributes	UINT	ID of the last class attribute	7
7	Get	Maximum ID Number Instance Attributes	UINT	ID of the last instance attribute	0

Instance attributes

34402

The object has no instance attributes.

Supported services

34375

Service code		Name	Class	Attribute	Description
dec	hex				
14	0E	Get_Attribute_Single	yes	yes	Read single attribute
16	10	Set_Attribute_Single	no	yes	Change single attribute
78	4E	Forward_Close	yes	no	Close connection
84	54	Forward_Open	yes	no	Open new connection

Device Level Ring Object (object class: 0x47)

34345

The Device Level Ring (DLR) Object represents the interface for configuration and status information.

Class attributes

34313

Attr ID	Access	Name	Data type	Description	Value
1	Get	Revision	UINT	Revision of the object	3
2	Get	Max instance	UINT	Max. number of instances of the object	1
6	Get	Maximum ID Number Class Attributes	UINT	ID of the last class attribute	7
7	Get	Maximum ID Number Instance Attributes	UINT	ID of the last instance attribute	12

Instance attributes

34327

Attr. ID	Access	Name	Data type	Description	Preset	
1	Get	Network Topology	USINT	current network topology	0	
2	Get	Network status	USINT	current network status	0	
10	Get	Active Supervisor	STRUCT of	Identification of the supervisor	0	
			▪ UDINT	IP address of the supervisor		
			▪ ARRAY of 6 USINTs	MAC address of the supervisor		
12	Get	Capability Flags	DWORD	DLR functions of the device	0x82	
				Bit 0	Announced-based ring node	0
				Bit 1	Beacon-based ring node	1
				Bit 2...4	reserved	--
				Bit 5	Supervisor capable	0
				Bit 6	Redundant Gateway capable	0
				Bit 7	Flush_Table frame capable	1
				Bit 8..31	reserved	--

I

Supported services

34409

Service code		Name	Class	Attribute	Description
dec	hex				
1	01	Get_Attribute_All	no	yes	Read all attribute values
14	0E	Get_Attribute_Single	yes	yes	Read single attribute value

Quality of Service (object class: 0x48)

34371

Quality of Service (QoS) enables prioritising of Ethernet frames. The priorities of the Ethernet frames can be influenced with the attributes "Differentiate Service Code Points" (DSCP) or "802.1Q Tag".

Class attributes

34307

Attr ID	Access	Name	Data type	Description	Value
1	Get	Revision	UINT	Revision of the object	3
2	Get	Max instance	UINT	Max. number of instances of the object	1
6	Get	Maximum ID Number Class Attributes	UINT	ID of the last class attribute	7
7	Get	Maximum ID Number Instance Attributes	UINT	ID of the last instance attribute	8

Instance attributes

34328

Attr ID	Access	Name	Data type	Description	Value
1	Get	802.1Q tagRevision	USINT	Current network topology	0
2	Get, Set	DSCP PTP Event	USINT	DSCP value for PTP event frames	59
3	Get, Set	DSCP PTP general	USINT	DSCP value for PTP general frames	47
4	Get, Set	DSCP PTP Urgent	USINT	DSCP value for implicit messages with "urgent" priority	55
5	Get, Set	DSCP Scheduled	USINT	DSCP value for implicit messages with "scheduled" priority	47
6	Get, Set	DSCP High	USINT	DSCP value for implicit messages with "high" priority	43
7	Get, Set	DSCP Low	USINT	DSCP value for implicit messages with "low" priority	31
8	Get, Set	DSCP explicit	USINT	DSCP value for explicit messages with "scheduled" priority	27

Supported services

34406

Service code		Name	Class	Attribute	Description
dec	hex				
01	01	Get_Attribute_All	yes	yes	Read all attribute values
14	0E	Get_Attribute_Single	no	yes	Read single attribute value

IO-Link requests (object class: 0x80)

34412

The manufacturer-specific object "IO-Link Requests" enables read and write access to the IO-Link objects of an IO-Link device connected to a AL1222 via ISDU (Index Service Data Unit). The object projects the mechanisms of the CIP addressing on the IO-Link protocol.

Class attributes

34308

Attr ID	Access	Name	Data type	Description	Value
1	Get	Revision	UINT	Revision of the object	4
2	Get	Max instance	UINT	Max. number of instances of the object	2
6	Get	Maximum ID Number Class Attributes	UINT	Number of instances of the object	8

Instance attributes

34399

The required IO-Link port of the device is addressed via the instance attribute.

Supported services

34378

Service code		Name	Class	Attribute	Description
dec	hex				
75	4B	→ Read_ISDU (→ S. 96)	no	yes	Read ISDU
76	4C	→ Write_ISDU (→ S. 99)	no	yes	Read ISDU
77	4D	→ Write Failsafe Pattern (→ S. 102)	no	yes	Write failsafe values of IO-Link port

Read_ISDU

34323

With Read_ISDU, parameters of a connected IO-Link device can be read.

Request

34337

CIP Attribute determines the IO-Link port to which the IO-Link device is connected. The area CIP User Specific Service Data contains the IO-Link index and the IO-Link sub-index of the IO-Link object whose value is to be read:

CIP format	Data type	MSG Config	IO-Link mapping
CIP Class ID	UINT	0x80	IO-Link acyclic access
CIP Instance ID	UINT	0x01	IO-Link master
CIP Attributes	USINT	0x01...0x08	Port number
CIP Service code ID	USINT	0x4B	Request "Read_ISDU"
CIP User specific service data	UINT	0x0000...0xFFFF	IO-Link ISDU object index
	USINT	0x00...0xFF	IO-Link ISDU object sub-index

Response

34326

- **Positive response**

If the service has been executed successfully (CIP Error Code = 0), the read data are returned bit by bit (CIP User Specific Service Data). The answer has the following format:

CIP format	Data type	MSG Config	IO-Link mapping
CIP Class ID	UINT	0x80	IO-Link acyclic access
CIP Instance ID	UINT	0x01	IO-Link master
CIP Attributes	USINT	0x01...0x08	Port number
CIP Service Code ID	USINT	0x4C	Response "Read_ISDU"
CIP Error Code	USINT	0x00	--
CIP Extended Error Code	USINT	0x00	--
CIP User Specific Service Data	USINT	0x00...0xFF	Data (byte 0)
	USINT	0x00...0xFF	Data (byte 1)

	USINT	0x00...0xFF	Data (byte n)



The read data is in the IO-Link format. If necessary, the user needs to adapt the byte arrangement of the read data to the CIP format.

- **Negative response**

If an error occurs while executing the service (CIP Error Code \neq 0), an extended error code is transmitted. If the CIP Error Code = 0x1E, then the CIP Extended Error Code = 0x00 and the CIP User Specific Service Data area contains the IO-Link Error Code as well as IO-Link Additional Code. The answer has the following format:

CIP format	Data type	MSG Config	IO-Link mapping
CIP Class ID	UINT	0x80	IO-Link acyclic access
CIP Instance ID	UINT	0x01	IO-Link master
CIP Attributes	USINT	0x01...0x08	Port number
CIP Service Code ID	USINT	0x4B	Response "Read_ISDU"
CIP Error Code	USINT	\neq 0x00	Error code: see table below
CIP Extended Error Code	USINT	0x00	Extended error code
CIP User Specific Service Data	USINT	\neq 0x00	IO-Link Error Code: → Error codes (→ S. 78) (only if CIP Error Code = 0x1E)
	USINT	\neq 0x00	IO-Link Additional Code: → Additional Codes (→ S. 78) (only if CIP Error Code = 0x1E)

CIP Error Code:

Code	Description
0x02	Resource not available: The IO-Link port is busy processing another acyclic service.
0x05	Invalid class ID or instance ID
0x08	Wrong service ID: only service code 0x4B or 0x4C is permitted
0x09	Wrong attribute ID: wrong port number
0x20	Invalid parameter value (e.g. invalid length)
0x1E	Embedded service, error: Error occurred during an IO-Link service. Byte 0 and byte 1 of the User Specific Service Data contain the IO-Link error code and an additional code that are returned by the IO-Link master.

Example: reading the parameter value of an IO-Link device

Task: reading the value of the parameter X of an IO-Link device

- IO-Link device at the port: 0x02
- Parameter X in the object directory of an IO-Link device: Index: 90, sub-index 3

From this, the following results for the configuration of the EtherNet/IP command Message (MSG):

CIP format	Data type	MSG Config	Description
CIP Class ID	UINT	0x80	IO-Link acyclic access
CIP Instance ID	UINT	0x01	IO-Link master
CIP Attributes	USINT	0x02	Port number
CIP Service Code ID	USINT	0x4B	Request "ISDU_Read"
CIP User Specific Service Data	UINT	0x005A	IO-Link ISDU object index
	USINT	0x03	IO-Link ISDU object sub-index

After successful execution of the request, the response area has the following content:

CIP format	Data type	MSG Config	Description
CIP Class ID	UINT	0x80	Object class "IO-Link requests"
CIP Instance ID	UINT	0x01	IO-Link master
CIP Attributes	USINT	0x02	Port number
CIP Service Code ID	USINT	0x4B	Response "ISDU_Read"
CIP Error Code	USINT	0x00	Request processed successfully
CIP Extended Error Code	USINT	0x00	--
CIP User Specific Service Data	USINT	e.g. 0x12	Parameter value that has been read (byte 0)
	USINT	e.g. 0x34	Parameter value that has been read (byte 1)

If an error occurs while the request is executed, the response area has the following content:

CIP format	Data type	MSG Config	Description
CIP Class ID	UINT	0x80	Object class "IO-Link requests"
CIP Instance ID	UINT	0x01	IO-Link master
CIP Attributes	USINT	0x02	Port number
CIP Service code ID	USINT	0x4B	Response "ISDU_Read"
CIP Error code	USINT	0x1E	Error code: Embedded service error
CIP Extended error code	USINT	0x00	--
CIP User specific service data	USINT	e.g. 0x80	IO-Link Error Code: Error in device application
	USINT	e.g. 0x20	IO-Link Additional Code: Service temporarily unavailable

Write_ISDU

34385

With Write_ISDU, the parameters of a connected IO-Link device can be changed.

Request

34387

CIP Attribute determines the IO-Link port to which the IO-Link device is connected. The area CIP User Specific Service Data contains the IO-Link index, the IO-Link sub-index of the IO-Link object whose value is to be changed. It is followed, bit by bit, by the value that is to be assigned to the parameter.

CIP format	Data type	MSG Config	IO-Link mapping
CIP Class ID	UINT	0x80	IO-Link acyclic access
CIP Instance ID	UINT	0x1	IO-Link master
CIP Attribute	USINT	0x01...0x08	Port number
CIP Service Code ID	USINT	0x4C	Request "Write_ISDU"
CIP User Specific Service Data	UINT	0x0000...0xFFFF	IO-Link ISDU object index
	USINT	0x00...0xFF	IO-Link ISDU object sub-index
	USINT	0x00...0xFF	IO-Link ISDU data (byte 0)
	USINT	0x00...0xFF	IO-Link ISDU data (byte 1)

Response

34384

- **Positive response**

If the service has been executed successfully (CIP Error Code = 0), the area CIP User Specific Service Data stays empty. The answer has the following format:

CIP format	Data type	MSG Config	IO-Link mapping
CIP Class ID	UINT	0x80	IO-Link acyclic access
CIP Instance ID	UINT	0x01	IO-Link master
CIP Attribute	USINT	0x01...0x08	Port number
CIP Service Code ID	USINT	0x4C	Response "Write_ISDU"
CIP Error Code	USINT	0x00	--
CIP Extended Error Code	USINT	0x00	--

- **Negative response**

If an error occurs while executing the service (CIP Error Code \neq 0), an extended error code is transmitted. If the CIP Error Code = 0x1E, then the CIP Extended Error Code = 0x00 and the CIP User Specific Service Data area contains the IO-Link Error Code as well as IO-Link Additional Code. The answer has the following format:

CIP format	Data type	MSG Config	IO-Link mapping
CIP Class ID	UINT	0x80	IO-Link acyclic access
CIP Instance ID	UINT	0x01	IO-Link master
CIP Attributes	USINT	0x01...0x08	Port number
CIP Service Code ID	USINT	0x4C	Response "Write_ISDU"
CIP Error Code	USINT	\neq 0x00	Error code. see table below
CIP Extended Error Code	USINT	0x00	Extended error code
CIP User Specific Service Data	USINT	\neq 0x00	IO-Link Error Code: → Error codes (→ S. 78) (only if CIP Error Code = 0x1E)
	USINT	\neq 0x00	IO-Link Additional Code: → Additional Codes (→ S. 78) (only if CIP Error Code = 0x1E)

CIP Error Code:

Code	description
0x02	Resource not available: The IO-Link port is busy processing another acyclic service.
0x05	Invalid class ID or instance ID
0x08	Wrong service ID: only service code 0x4B or 0x4C is permitted
0x09	Wrong attribute ID: wrong port number
0x20	Invalid parameter value (e.g. invalid length)
0x1E	Embedded service, error: Error occurred during an IO-Link service. Byte 0 and byte 1 of the User Specific Service Data contain the IO-Link error code and an additional code that are returned by the IO-Link master (see below).

Example: changing the parameter value of an IO-Link device

34355

Task: changing the parameter X of an IO-Link device

- IO-Link device at the port: 0x03
- Parameter X in the object directory of an IO-Link device: Index: 91, sub-index 5
- new parameter value: 0xABCD

From this, the following results for the configuration of the EtherNet/IP command Message (MSG):

CIP format	Data type	MSG Config	Description
CIP Class ID	UINT	0x80	IO-Link acyclic access
CIP Instance ID	UINT	0x01	IO-Link master
CIP Attributes	USINT	0x03	Port number
CIP Service code ID	USINT	0x4C	Service "Write_ISDU"
CIP User specific service data	UINT	0x005B	IO-Link ISDU object index
	USINT	0x05	IO-Link ISDU object sub-index
	USINT	0xAB	New parameter value (MSB)
	USINT	0xCD	New parameter value (LSB)

After successful execution of the request, the response area has the following content:

CIP format	Data type	MSG Config	Description
CIP Class ID	UINT	0x80	Object class "IO-Link Requests"
CIP Instance ID	UINT	0x01	IO-Link master
CIP Attributes	USINT	0x03	Port number
CIP Service code ID	USINT	0x4B	Service "Write_ISDU"
CIP Error code	USINT	0x00	Request processed successfully
CIP Extended error code	USINT	0x00	--

If an error occurs while the request is executed, the response area has the following content:

CIP format	Data type	MSG Config	Description
CIP Class ID	UINT	0x80	Object class "IO-Link Requests"
CIP Instance ID	UINT	0x01	IO-Link master
CIP Attributes	USINT	0x03	Port number
CIP Service code ID	USINT	0x4B	Service "Write_ISDU"
CIP Error code	USINT	0x1E	Error code: Embedded Service Error
CIP Extended error code	USINT	0x00	--
CIP User specific service data	USINT	0x80	IO-Link Error Code: Error in device application
	USINT	0x23	IO-Link Additional Code: Access denied

Write Failsafe Pattern

54597

By using Write Failsafe Pattern the fail-safe value of a IO-Link port can be written.

Request

54694

CIP Attribute determines the IO-Link port. The area CIP User Specific Service Data includes the fail-safe mode and the fail-safe value (Failsafe Pattern).

CIP Format	Data type	MSG Config	Description
CIP Class ID	UINT	0x80	IO-Link acyclic access
CIP Instance ID	UINT	0x01	IO-Link master
CIP Attribute	USINT	0x01...0x08	Port number
CIP Service Code ID	USINT	0x4D	Request "Write Failsafe Pattern"
CIP User Specific Service Data	USINT	0x00 = No Fail-safe 0x01 = Fail-safe Reset Value 0x02 = Fail-safe Old Value 0x03 = Fail-safe with Pattern	Failsafe Mode
	USINT	0x00...0xFF	Failsafe Pattern (MSB)
	USINT	0x00...0xFF	Failsafe Pattern (LSB)

Response

54695

- **Positive response**

If the service was executed successfully (CIP Error Code = 0), the area "User Specific Data" will remain empty. The response has the following format:

CIP Format	Data type	MSG Config	Description
CIP Class ID	UINT	0x80	IO-Link acyclic access
CIP Instance ID	UINT	0x01	IO-Link master
CIP Attribute	USINT	0x01...0x08	Port number
CIP Service Code ID	USINT	0x4D	Response "Write Failsafe Pattern"
CIP Error Code	USINT	0x00	--
CIP Extended Error Code	USINT	0x00	--

- **Negative response**

If an error occurs while executing the service (CIP Error Code \neq 0), an extended error code is transmitted (CIP Extended Error Code). The answer has the following format:

CIP-Format	Data type	MSG Config	Description
CIP Class ID	UINT	0x80	IO-Link acyclic access
CIP Instance ID	UINT	0x01	IO-Link master
CIP Attribute	USINT	0x01...0x08	Port number
CIP Service Code ID	USINT	0x4D	Response "Write Failsafe Pattern"
CIP Error Code	USINT	\neq 0x00	Error code: see below
CIP Extended Error Code	USINT	\neq 0x00	Extended error code

CIP Error Code:

Code	Description
0x02	Resource not available: The IO-Link port is busy processing another acyclic service.
0x05	Invalid class ID or instance ID
0x08	Wrong service ID: only service 0x4B, 0x4C or 0x4D is permitted
0x09	Wrong attribute ID: wrong port number
0x20	Invalid parameter value (e.g. invalid length)
0x1E	Embedded service, error: Error occurred during an IO-Link service. Byte 0 and byte 1 of the User Specific Service Data contain the IO-Link error code and an additional code that are returned by the IO-Link master (see below).
0x0F	Insufficient access rights

Example: Write fail-safe value

54696

Task: Write fail-safe mode for IO-Link port X02 to "Fail-safe with pattern" and fail-safe value to 0x1234

- IO-Link device in the port: 0x02
- Fail-safe mode: 0x03
- Fail-safe value: 0x1234

From this, the following results for the configuration of the EtherNet/IP command message (MSG):

CIP Format	Data type	MSG Config	Description
CIP Class ID	UINT	0x80	IO-Link acyclic access
CIP Instance ID	UINT	0x01	IO-Link master
CIP Attribute	USINT	0x02	Port number
CIP Service Code ID	USINT	0x4D	Request "Write Failsafe Pattern"
CIP User Specific Service Data	USINT	0x03	"Fail-safe with Pattern" mode
	USINT	0x12	Failsafe Pattern (MSB)
	USINT	0x34	Failsafe Pattern (LSB)

After successful execution of the request, the response area has the following content:

CIP-Format	Data type	MSG Config	Description
CIP Class ID	UINT	0x80	IO-Link acyclic access
CIP Instance ID	UINT	0x01	IO-Link master
CIP Attribute	USINT	0x02	Port number
CIP Service Code ID	USINT	0x4D	Response "Write Failsafe Pattern"
CIP Error Code	USINT	0x00	Request processed successfully
CIP Extended Error Code	USINT	0x00	--

If an error occurs while the request is executed, the response area will have the following content:

CIP-Format	Data type	MSG Config	Description
CIP Class ID	UINT	0x80	IO-Link acyclic access
CIP Instance ID	UINT	0x01	IO-Link master
CIP Attribute	USINT	0x02	Port number
CIP Service Code ID	USINT	0x4D	Response "Write Failsafe Pattern"
CIP Error Code	USINT	e. g. 0x0F	Error code: Insufficient access rights
CIP Extended Error Code	USINT	0x00	no additional information

TCP/IP object (object class: 0xF5)

34388

TCP/IP Interface Object enables the configuration of the physical network interface of the device.

Class attributes

34311

Attr ID	Access	Name	Data type	Description	Value
1	Get	Revision	UINT	Revision of the object	4
2	Get	Max instance	UINT	Max. number of instances of the object	1

Instance attributes

34330

Attr. ID	Access	Name	Data type	Description	Preset		
1	Get	Status	DWORD	Status of the TCP/IP interface			
				Bit 0...3		Configuration status of the interface	
				Bit 4		Mcast pending (always 0)	
				Bit 5		Interface configuration pending	
				Bit 6		ACD Status	
				Bit 7		ACD Fault	
				Bit 8...31		reserved	
2	Get	Configuration Capability	DWORD	Functions of the interface (flags)	0x95 (BOOTP, DHCP Client, TCP/IP configurable, ACD capable)		
				Bit 0		BOOTP Client	
				Bit 1		reserved	
				Bit 2		DHCP Client	
				Bit 3		reserved	
				Bit 4		TCP/IP configurable via EtherNet/IP	
				Bit 5		reserved	
				Bit 6		reserved	
				Bit 7		ACD Capable	
Bit 8...31	reserved						
3	Get, Set	Configuration Control	DWORD	Interface control (control flags):	0		
				Bit 0...3		Start-up configuration	
						0	Static IP configuration
						1	Configuration via BOOTP
						2	Configuration via DHCP
				Bit 4		reserved	
Bit 5...31	reserved						
4	Get	Physical Link Object path	STRUCT:	Logical path to the physical communication interface: the Ethernet Link object			
		▪ Path Size	▪ UINT	Length (in Little Endian Format as WORD)	02 00		

Attr. ID	Access	Name	Data type	Description	Preset	
		▪ Path	▪ Padded EPATH	Path Class ID = 0xF6 Ethernet Link Object Instance ID = 1	20 F6 24 01	
5	Get, Set	Interface Configuration	STRUCT:	TCP/IP configuration		
		▪ IP Address	▪ UDINT	IP address	192.168.1.250	
		▪ Network mask	▪ UDINT	Subnet mask	255.255.255.0	
		▪ Gateway address	▪ UDINT	Default gateway address	0.0.0.0	
		▪ Name Server	▪ UDINT	1. Name Server	0.0.0.0	
		▪ Name Server 2	▪ UDINT	2. Name Server	0.0.0.0	
		▪ Domain Name	▪ STRING	Default domain name	0	
6	Get, Set	Host name	STRING	Host name	0	
				0 no name configured		
8	Get	TTL value		TTL value	1	
9	Get	Mcast Config			0	
10	Get, Set	SelectAcid	BOOL	activate ACD	1	
				0 deactivate		
				1 activate		
11	Get, Set	Last Conflict Detected	STRUCT:	Structure with information via the latest detected conflict	0	
				▪ USINT		Condition of the ACD activity with the latest detected conflict
				0 Noconflictdetected		
				1 Probelpv4Address		
				2 OngoingDetection		
				3 SemiActiveProbe		
				▪ ARRAY of 6 USINT		MAC address
▪ ARRAY of 28 USINT	Copy of the data of the ARP PDU in which the conflict was detected					
13	Get, Set	Encapsulation Inactivity Timeout	UINT	Inactivity before the TCP connection is deactivated (in seconds)	120	

Supported services

34416

Service code		Name	Class	Attribute	Description
dec	hex				
01	01	Get_Attribute_All	no	yes	Read all attributes
14	0E	Get_Attribute_Single	yes	yes	Read single attribute
16	10	Set_Attribute_Single	no	yes	Change single attribute

Ethernet Link Object (object class: 0xF6)

34354

The Ethernet Link Object contains status information of the Ethernet interface.

Class attributes

34312

Attr ID	Access	Name	Data type	Description	Value
1	Get	Revision	UINT	Revision of the object	4
2	Get	Max Instance	UINT	Max. number of instances of the object	2
3	Get	Number of Instances	UINT	Number of instances of the object	2

Instance attributes

34333

Attr. ID	Access	Name	Data type	Description	Preset	
1	Get	Interface Speed	UDINT	Current data rate (in bytes/s) 10 Mbps, 100 Mbps.	100	
2	Get	Interface Status Flags	DWORD	Status flag of the interface	0x20	
				Bit 0	Link status	
				Bit 1	Half/full duplex	
				Bit 2...4	Auto negotiation status	
				Bit 5	Manual setting requires reset	
				Bit 6	Local Hardware Fault	
Bit 7...31	reserved					
3	Get	Physical Address	ARRAY of 6 USINTs	MAC address		
4	Get	Interface Counters	STRUCT of 11 UDINTs	Interface-specific counter		
5	Get	Media counters	STRUCT of 12 UDINTs	Medium-specific counter		
6	Get, Set	Interface control	STRUCT of	Control bits: Bit 0: Auto negotiate Bit 1: Forced Duplex Mode (full 1, half 0)	0	
				▪ WORD		Control bits of the interface
				Bit 0		0 = auto-negotiation active
						1 = auto-negotiation inactive
				Bit 1		0 = Half duplex
						1 = Full duplex
				Bit 2..15		reserved
				▪ UINT		Data rate of the interface
10	10 Mbps					
100	100 Mbps					
7	Get	Interface Type	USINT	Physical interface type	2	
				0		unknown
				1		Internal interface
				2		Twisted pair

Attr. ID	Access	Name	Data type	Description	Preset
				3 Optical fibre	
				4...255 reserved	
8	Get	Interface state	USINT	Current status of the interface	0
				0 unknown	
				1 active; ready for transmission and reception	
				2 not active	
				3 Test mode	
				4...255 reserved	
9	Get	Admin State	USINT	Control of the access to the interface	1
				0 reserved	
				1 Activate interface	
				2 Deactivate interface	
				3...255 reserved	
10	Get	Interface label	SHORT_STRING	Designation of the interface	"X21" (instance 1) "X22" (instance 2)
11	Get	Interface capability	STRUCT of	Capabilities of the interface	
			▪ DWORD	Transmission rate	
				10 10 Mbps	
				100 100 Mbps	
			▪ DWORD	Duplex mode	
				HD Half duplex	
				FD Full duplex	
300	Get, Set	MDIX	???	MDIX configuration	3
				0	
				1 MDI	
				2 MDIX	
				3 autoMDI	
				4...255 reserved	

Supported services

34414

Service code		Name	Class	Attribute	Description
dec	hex				
01	01	Get_Attribute_All	no	yes	Read all attribute values
14	0E	Get_Attribute_Single	yes	yes	Read single attribute value
16	10	Set_Attribute_Single	no	yes	Change single attribute value

14 Index

A

Accessories	51
Acyclic command channel	74
Acyclic commands	79
Acyclic data	74
Acyclic port commands	46
Additional Codes	78
Appendix	52
Application	53
Approvals / tests	56
Assembly Object (object class 0x04)	91

C

CIP class services	86
CIP object classes	87
Class attributes	88, 90, 91, 92, 93, 94, 95, 105, 107
Cleaning process	47
Command 0x10 – Set mode	80
Command 0x20 – Set validation ID / data storage	82
Command 0x30 – Set fail-safe data pattern	84
Command channels in cyclic process data	45
Command request	80, 82, 84
Command response	81, 83, 85
Communication, parameter setting, evaluation	10
Configuration	22
Configuration Assembly (Instance 199)	60
Configure AL1222	38
Configure IO-Link devices	34, 41
Configure IO-Link ports	39
Connect the device	16
Connection Manager Object (object class 0x06)	92
Cyclic data	63

D

Derating characteristics	54
Device Level Ring Object (object class 0x47)	93
Digital inputs	11

E

Electrical connection	13, 57
Electrical data	53
Error codes	78
Ethernet interface	18
Ethernet Link Object (object class 0xF6)	107
Ethernet ports	14
EtherNet/IP	10, 35, 58
Programmers' notes	44
EtherNet/IP mechanisms for acyclic commands	46
Example	
changing the parameter value of an IO-Link device	101
reading the parameter value of an IO-Link device	98
Write fail-safe value	104
Explanation of Symbols	6

F

Factory Settings	50
Field bus objects	86
Fieldbus	
Configure IP settings	27
set the configuration mode	28
Firmware	
Reboot the device	33
Reset device to factory settings	33
Firmware update	48
Function	9

G

General	7
---------------	---

I

Identity Object (object class 0x01)	88
Info	
Show device information	32
Input assembly (Instance 100)	
I/O data + acyclic data + diagnosis data	64
Input Assembly (Instance 101)	
I/O data + acyclic data	65
Input Assembly (Instance 102)	
I/O data	66
Inputs	55
Inputs / outputs	55
Instance attributes	88, 90, 91, 92, 93, 94, 95, 105, 107
Integrate the AL1222 into the EtherNet/IP project	36
Intended use	8
Interfaces	55
IO-Link	10
IO-Link ports	
Activate data transfer to LR AGENT or LR SMARTOBSERVER	29
Configure operating mode	30
Set the device validation and data storage	31
IO-Link Ports	
Set fails-safe values	32
IO-Link Ports	15
IO-Link ports (Class A)	19
IO-Link ports (Class B)	19
IO-Link requests (object class 0x80)	95
IO-Link supply	11
IoT	
Configure access rights	25
Configure the interface to LR AGENT or LR SMARTOBSERVER	26

L

LED indicators	18
Legal and copyright information	5
LR DEVICE	23

M

Maintenance, repair and disposal	47
Mapping	
digital input data (DI)	67
Digital output data (DO)	73
IO-Link port information	69
Port configuration	61

PQI.....	68
Status information	67
Mechanical data.....	56
Message Router Object (object class 0x02).....	90
Modification history	6
Mount the device	12
Mounting	12

N

Notes.....	13
------------	----

O

Offline parameter setting	24
Operating and display elements	17
Operating conditions.....	56
Output assembly (Instance 150) I/O data + acyclic data	71
Output Assembly (Instance 151) I/O data.....	72
Outputs	55
Overview.....	17

P

Parameter data	59
Parameter setting	11
Permitted use.....	8
Preliminary note.....	5
Principle of the command channels	45
Prohibited use.....	8
Purpose of the document	5

Q

Quality of Service (object class 0x48).....	94
--	----

R

Read cyclic input data	42
Read device and diagnostic information	21
Read diagnostic and status information	43
Read_ISDU.....	96
Registration of the EDS file	35
Remarks.....	24
Replace IO-Link device	49
Request.....	96, 99, 102
Request channel.....	75
Required background knowledge.....	7
Response.....	96, 99, 102
Response channel.....	76

S

Safety instructions	7
Safety symbols on the device.....	7
Set connection types and RPI.....	37
Set-up	20
Status LEDs.....	18
Supported connection types.....	58
Supported EtherNet/IP configuration modes.....	44
Supported services.....	89, 90, 91, 92, 93, 94, 95, 106, 108

T

Tampering with the unit	7
TCP/IP object (object class 0xF5).....	105
Technical data	53

U

Use acyclic services	45
----------------------------	----

V

Visual indication.....	11
Voltage output.....	11
Voltage supply	19
VPN connection.....	24

W

Write cyclic output data	42
Write Failsafe Pattern	102
Write_ISDU.....	99